

Cables for Rotary Servomotors

System Configurations

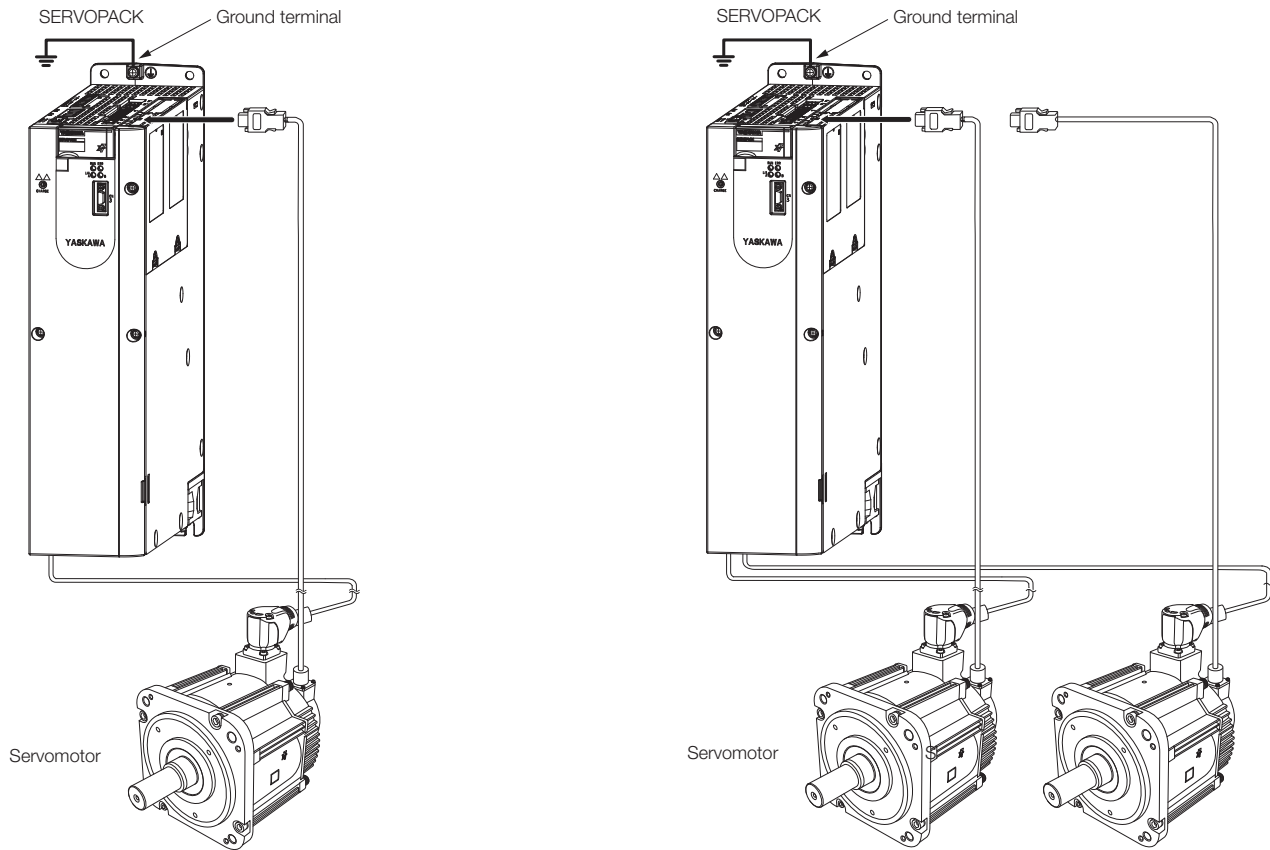

Notes:

1. If you use a Servomotor Main Circuit Cable that exceeds 20 m, the intermittent duty zone in the torque speed characteristics will become smaller because the voltage drop increases.
2. Refer to the following manual for the following information.
 - Cable dimensional drawings and cable connection specifications
 - Order numbers and specifications of individual connectors for cables
 - Order numbers and specifications for wiring materials

Sigma-7-Series AC Servo Drive Peripheral Device Selection Manual.

Power Cables for rotary servomotors without holding brake

Servomotor Model	Name	Cable & connector type	Length	Order No.	Specification
SGM7J-02 to -08 SGM7A-04 to -08	For Servomotors without holding brake	Flexible Power cable 4 x 1.5 mm ² with M17 connector	3 m	JZSP-C7M143-03-E-G6	
			5 m	JZSP-C7M143-05-E-G6	
			10 m	JZSP-C7M143-10-E-G6	
			15 m	JZSP-C7M143-15-E-G6	
			20 m	JZSP-C7M143-20-E-G6	
SGM7J-15 SGM7A-10 to -25 SGM7G-05 to -20 SGM7G-05 to -09 High Speed		Flexible Power cable 4 x 1.5 mm ² with M23 connector	3 m	JZSP-C7M144-03-E-G6	
			5 m	JZSP-C7M144-05-E-G6	
			10 m	JZSP-C7M144-10-E-G6	
			15 m	JZSP-C7M144-15-E-G6	
SGM7A-30 SGM7G-30 SGM7G-13 to -20 High Speed		Flexible Power cable 4 x 2.5 mm ² with M23 connector	3 m	JZSP-C7M154-03-E-G6	
			5 m	JZSP-C7M154-05-E-G6	
			10 m	JZSP-C7M154-10-E-G6	
			15 m	JZSP-C7M154-15-E-G6	
SGM7A-40 to -50 SGM7G-44 SGM7G-30 High Speed		Flexible Power cable 4 x 4 mm ² with M23 connector	3 m	JZSP-C7M164-03-E-G6	
			5 m	JZSP-C7M164-05-E-G6	
	10 m		JZSP-C7M164-10-E-G6		
	15 m		JZSP-C7M164-15-E-G6		
SGM7A-70 SGM7G-55 to -75 SGM7G-44 High Speed	Flexible Power cable 4 x 6.0 mm ² with M40 connector	3 m	JZSP-C7M175-03-E-G6		
		5 m	JZSP-C7M175-05-E-G6		
		10 m	JZSP-C7M175-10-E-G6		
		15 m	JZSP-C7M175-15-E-G6		
SGM7G-1A to -1E	Flexible Power cable 4 x 10.0 mm ² with M40 connector	3 m	JZSP-C7M185-03-E-G6		
		5 m	JZSP-C7M185-05-E-G6		
		10 m	JZSP-C7M185-10-E-G6		
		15 m	JZSP-C7M185-15-E-G6		
			20 m	JZSP-C7M185-20-E-G6	



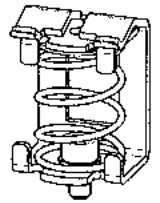

Motor Connection Shielding Clamp

Shielding clamp mountable on Sigma-7 400V SERVOPACKs up to 15kW.
Contact your YASKAWA representative for more information.

SERVOPACK Model	Order No.	Specification
Sigma-7 400 V up to 3.0 kW	KLBUE 4-13.5_SC	
Sigma-7 400 V from 5 kW up to 7.5 kW	KLBUE 10-20_SC	
Sigma-7 400 V for 11 kW & 15 kW	KLBUE 15-32_SC	

Cables for Rotary Servomotors

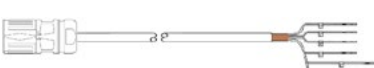
Power Cables for rotary servomotors with holding brake

Servomotor Model	Name	Cable & connector type	Length	Order No.	Specification
SGM7J-02 to -08 SGM7A-04 to -08		Flexible Power cable 4 x 1.5 mm ² & 2 x 1.5 mm ² for brake with M17 connector	3 m	JZSP-C7M343-03-E-G6	
			5 m	JZSP-C7M343-05-E-G6	
			10 m	JZSP-C7M343-10-E-G6	
			15 m	JZSP-C7M343-15-E-G6	
			20 m	JZSP-C7M343-20-E-G6	
SGM7J-15 SGM7A-10 to -25 SGM7G-05 to -20 SGM7G-05 to -09 High Speed		Flexible Power cable 4 x 1.5 mm ² & 2 x 1.5 mm ² for brake with M23 connector	3 m	JZSP-C7M344-03-E-G6	
			5 m	JZSP-C7M344-05-E-G6	
			10 m	JZSP-C7M344-10-E-G6	
			15 m	JZSP-C7M344-15-E-G6	
			20 m	JZSP-C7M344-20-E-G6	
SGM7A-30 SGM7G-30 SGM7G-13 to -20 High Speed	For Servomotors with holding brake	Flexible Power cable 4 x 2.5 mm ² & 2 x 1.5 mm ² for brake with M23 connector	3 m	JZSP-C7M354-03-E-G6	
			5 m	JZSP-C7M354-05-E-G6	
			10 m	JZSP-C7M354-10-E-G6	
			15 m	JZSP-C7M354-15-E-G6	
			20 m	JZSP-C7M354-20-E-G6	
SGM7A-40 to -50 SGM7G-44 SGM7G-30 High Speed		Flexible Power cable 4 x 4 mm ² & 2 x 1.5 mm ² for brake with M23 connector	3 m	JZSP-C7M364-03-E-G6	
			5 m	JZSP-C7M364-05-E-G6	
			10 m	JZSP-C7M364-10-E-G6	
			15 m	JZSP-C7M364-15-E-G6	
			20 m	JZSP-C7M364-20-E-G6	
SGM7A-70 SGM7G-55 to -75 SGM7G-44 High Speed		Flexible Power cable 4 x 6.0 mm ² & 2 x 1.5 mm ² for brake with M40 connector	3 m	JZSP-C7M375-03-E-G6	
			5 m	JZSP-C7M375-05-E-G6	
			10 m	JZSP-C7M375-10-E-G6	
			15 m	JZSP-C7M375-15-E-G6	
			20 m	JZSP-C7M375-20-E-G6	
SGM7G-1A to -1E		Flexible Power cable 4 x 10.0 mm ² & 2 x 1.5 mm ² for brake with M40 connector	3 m	JZSP-C7M385-03-E-G6	
			5 m	JZSP-C7M385-05-E-G6	
			10 m	JZSP-C7M385-10-E-G6	
			15 m	JZSP-C7M385-15-E-G6	
			20 m	JZSP-C7M385-20-E-G6	

Motor Connection Shielding Clamp

Shielding clamp mountable on Sigma-7 400V SERVOPACKs up to 15 kW.
Contact your YASKAWA representative for more information.

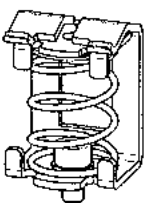
SERVOPACK Model	Order No.	Specification
Sigma-7 400 V up to 3.0 kW	KLBUE 4-13.5_SC	
Sigma-7 400 V from 5 kW up to 7.5 kW	KLBUE 10-20_SC	
Sigma-7 400 V for 11 kW & 15 kW	KLBUE 15-32_SC	

Encoder cables for rotary servomotors

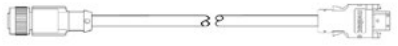
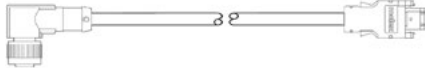
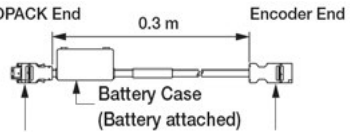
Servomotor Model	Name	Cable & connector type	Length	Sigma-7 Flexible Cable	Appearance
All 400 V motor types without absolute encoder	For servomotors with incremental encoder	Flexible Encoder cable with straight connector M12	3 m	JZSP-C7PI2M-03-E-G6	
			5 m	JZSP-C7PI2M-05-E-G6	
			10 m	JZSP-C7PI2M-10-E-G6	
			15 m	JZSP-C7PI2M-15-E-G6	
			20 m	JZSP-C7PI2M-20-E-G6	
		Flexible Encoder cable with angled connector M12	3 m	JZSP-C7PI2N-03-E-G6	
			5 m	JZSP-C7PI2N-05-E-G6	
			10 m	JZSP-C7PI2N-10-E-G6	
			15 m	JZSP-C7PI2N-15-E-G6	
			20 m	JZSP-C7PI2N-20-E-G6	
All 400 V motors with absolute encoder	For servomotors with absolute encoder	Sigma-7 Extension for Encoder cable with Connectors length 0.3m for Abs. Encoder	0.3 m	JZSP-CSP12-E-G5	

Fan cables for rotary servomotors

Servomotor Model	Name	Cable & connector type	Length	Sigma-7 Flexible Cable	Appearance