

# Heat / Cool temperature controller

1/8 DIN - 48 x 96



**ISO 9001**  
Certified

## X1 line

User Manual • 09/02 • Code: ISTR\_M\_X1\_E\_06\_--



**Ascon Tecnologic srl**  
viale Indipendenza 56, 27029 Vigevano (PV)  
Tel.: +39-0381 69 871 - Fax: +39-0381 69 8730  
Sito internet: [www.ascontecnologic.com](http://www.ascontecnologic.com)  
Indirizzo E-Mail: [sales@ascontecnologic.com](mailto:sales@ascontecnologic.com)

**Heat / Cool  
temperature controller  
1/8 DIN - 48 x 96**

**X1 line**

---

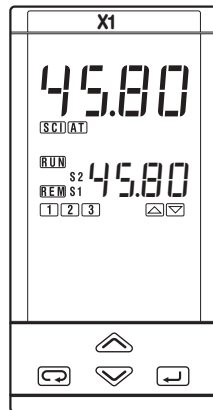



## NOTES

### ON ELECTRIC SAFETY AND ELECTROMAGNETIC COMPATIBILITY

**Please, read carefully these instructions before proceeding with the installation of the controller.**

**Class II instrument, rear panel mounting.**

This controller has been designed with compliance to:

**Regulations on electrical apparatus** (appliance, systems and installations) according to the European Community directive 73/23/EEC amended by the European Community directive 93/68/EEC and the Regulations on the essential protection requirements in electrical apparatus EN61010-1 : 93 + A2:95.

**Regulations on Electromagnetic Compatibility** according to the European Community directive n089/336/EEC, amended by the European Community directive No. 92/31/EEC, 93/68/EEC, 98/13/EEC and the following regulations:

Regulations on RF emissions

EN61000-6-3 : 2001 residential environments

EN61000-6-4 : 2001 industrial environments



Regulation on RF immunity

EN61000-6-2 : 2001 industrial equipment and system

**It is important to understand that it's responsibility of the installer to ensure the compliance of the regulations on safety requirements and EMC.**

The device has no user serviceable parts and requires special equipment and specialised engineers. Therefore, a repair can be hardly carried on directly by the user. For this purpose, the manufacturer provides technical assistance and the repair service for its Customers.

Please, contact your nearest Agent for further information.

**All the information and warnings about safety and electromagnetic compatibility are marked with the   sign, at the side of the note.**

# TABLE OF CONTENTS

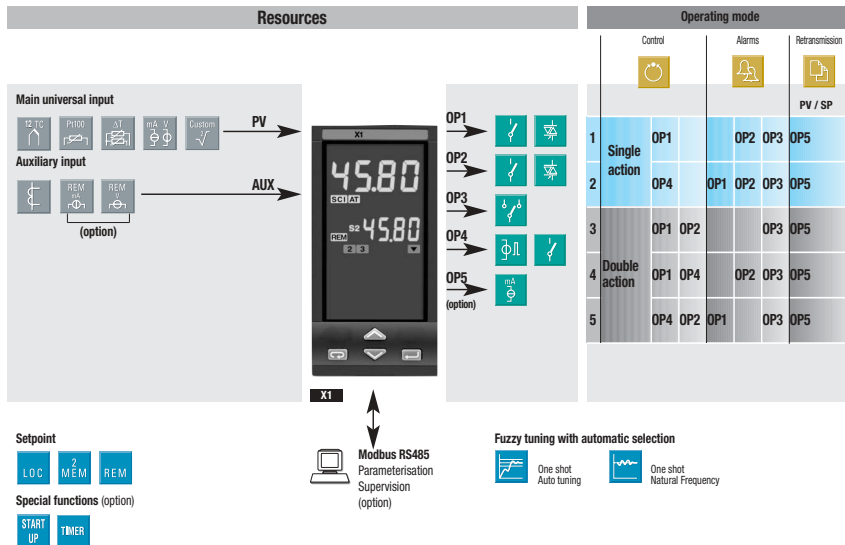

|          |                                       |         |
|----------|---------------------------------------|---------|
| <b>1</b> | <b>INSTALLATION</b> .....             | Page 4  |
| <b>2</b> | <b>ELECTRICAL CONNECTIONS</b> .....   | Page 8  |
| <b>3</b> | <b>PRODUCT CODING</b> .....           | Page 16 |
| <b>4</b> | <b>OPERATIONS</b> .....               | Page 21 |
| <b>5</b> | <b>DISPLAYS</b> .....                 | Page 47 |
| <b>6</b> | <b>COMMANDS</b> .....                 | Page 48 |
| <b>7</b> | <b>TECHNICAL SPECIFICATIONS</b> ..... | Page 52 |



## INSTALLATION

**Installation must only be carried out by qualified personnel.**

Before proceeding with the installation of this controller, follow the instructions illustrated in this manual and, particularly the installation precautions marked with the  symbol, related to the European Community directive on electrical protection and electromagnetic compatibility.



To prevent hands or metal touching parts that may be electrically live, **the controllers must be installed in an enclosure and/or in a cubicle.**

### 1.1 GENERAL DESCRIPTION

**IP 20 Terminal block**  
EN61010 - 1 (IEC1010 - 1)

Product code label

Mounting clamps

Sealing front panel gasket

Panel surface

**Front panel**  
**IP65 protection**  
EN 650529 (IEC 529)

## 1.2 DIMENSIONAL DETAILS

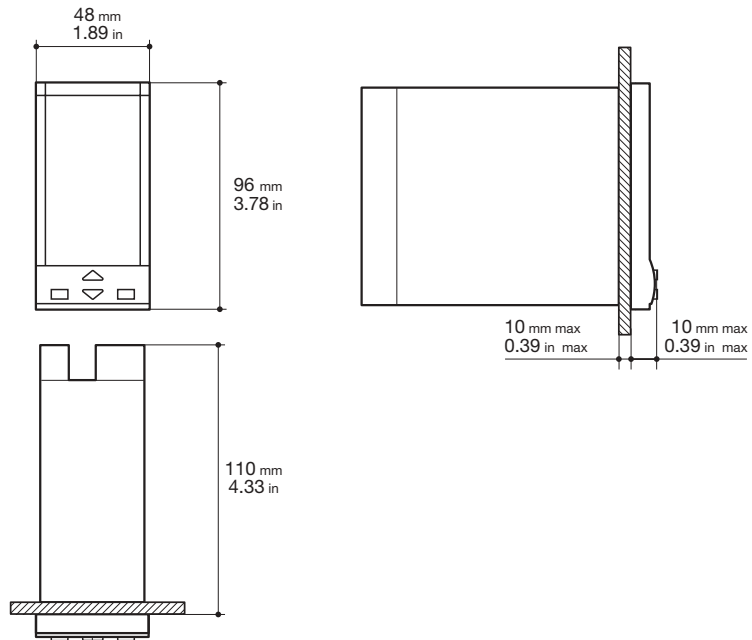

## 1.3 PANEL CUT-OUT

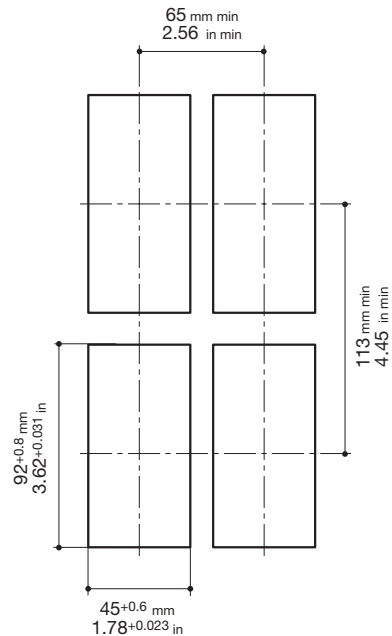

## 1.4 ENVIRONMENTAL RATINGS



---

**Operating conditions**

---



Altitude up to 2000 m



Temperature 0...50°C [1]

%Rh

Relative humidity 5...95 % non-condensing

---

**Special conditions**
**Suggestions**

Altitude &gt; 2000 m

Use 24Vac supply version



Temperature &gt;50°C

Use forced air ventilation

%Rh

Humidity &gt; 95 %

Warm up



Conducting atmosphere

Use filter

---

**Forbidden Conditions**

Corrosive atmosphere



Explosive atmosphere

**UL notes**

[1] Operating surrounding temperature  
0...50°C

## 1.5 PANEL MOUNTING [1]

### 1.5.1 INSERT THE INSTRUMENT

- 1 Prepare panel cut-out
- 2 Check front panel gasket position
- 3 Insert the instrument through the cut-out

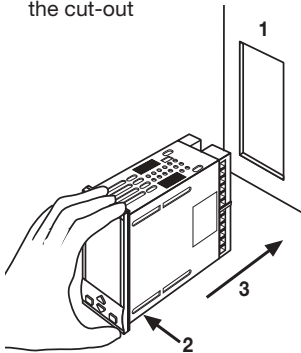

**UL note**  
 [1] For Use on a Flat Surface of a Type 2 and Type 3 'raintight' Enclosure.

### 1.5.2 INSTALLATION SECURING

- 1 Fit the mounting clamps
- 2 Push the mounting clamps towards the panel surface to secure the instrument

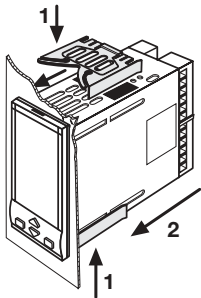

### 1.5.3 CLAMPS REMOVING

- 1 Insert the screwdriver in the clips of the clamps
- 2 Rotate the screwdriver

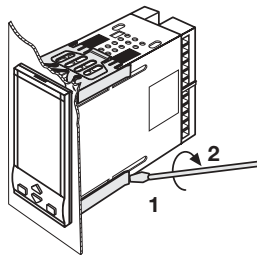

### 1.5.4 INSTRUMENT UNPLUGGING



- 1 Push and
- 2 pull to remove the instrument

Electrostatic discharges can damage the instrument



Before removing the instrument the operator must discharge himself to ground

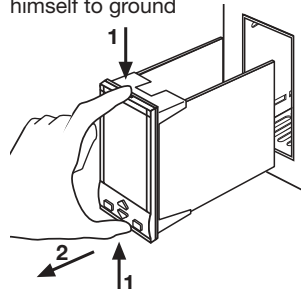



## ELECTRICAL CONNECTIONS

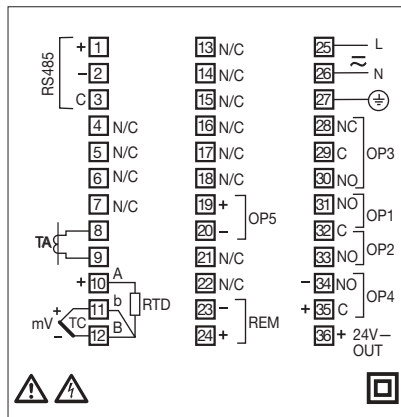

### UL notes

[1] Use 60/70 °C copper (Cu) conductor only.

[2] Wire size 1mm<sup>2</sup> (18 AWG Solid/Stranded)

## 2.1 TERMINATION UNIT [1]

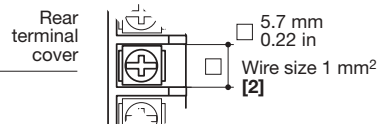
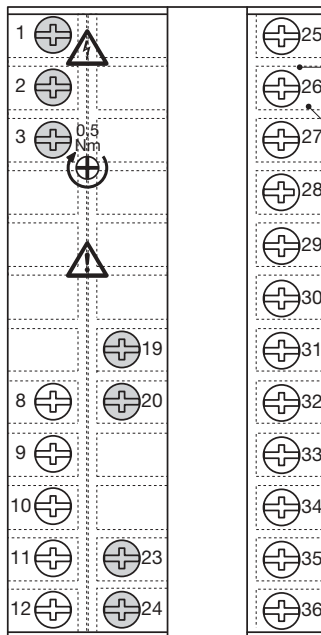

24 screw terminals M3

Option terminals

Tightening torque 0.5 Nm

Phillips screw-driver PH1

Flat blade screw-driver  
0.8 x 4 mm

### Terminals

Pin connector  
∅ 1.4 mm 0.055 in max.

Fork-shape AMP 165004  
∅ 5.5 mm - 0.21 in

Stripped wire  
L 5.5 mm - 0.21 in

**PRECAUTIONS**

Despite the fact that the instrument has been designed to work in an harsh and noisy environmental (level IV of the industrial standard IEC 801-4), it is recommended to follow the following suggestions.



All the wiring must comply with the local regulations.

The supply wiring should be routed away from the power cables. Avoid to use electromagnetic contactors, power Relays and high power motors nearby.

Avoid power units nearby, especially if controlled in phase angle

Keep the low level sensor input wires away from the power lines and the output cables.

If this is not achievable, use shielded cables on the sensor input, with the shield connected to earth.

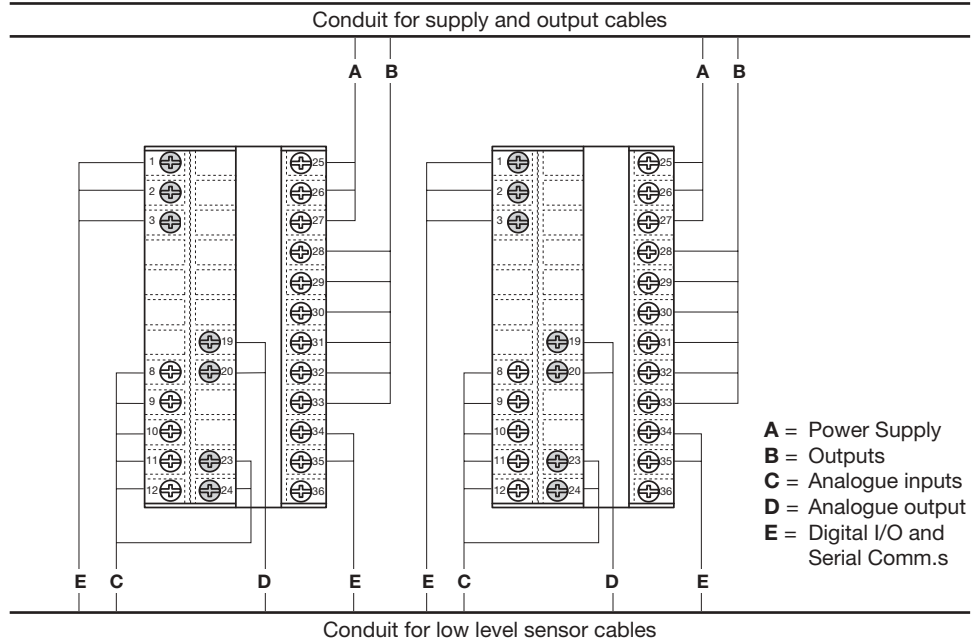
**2.2 SUGGESTED WIRES ROUTING**

## 2.3 EXAMPLE OF WIRING DIAGRAM (HEAT / COOL CONTROL)

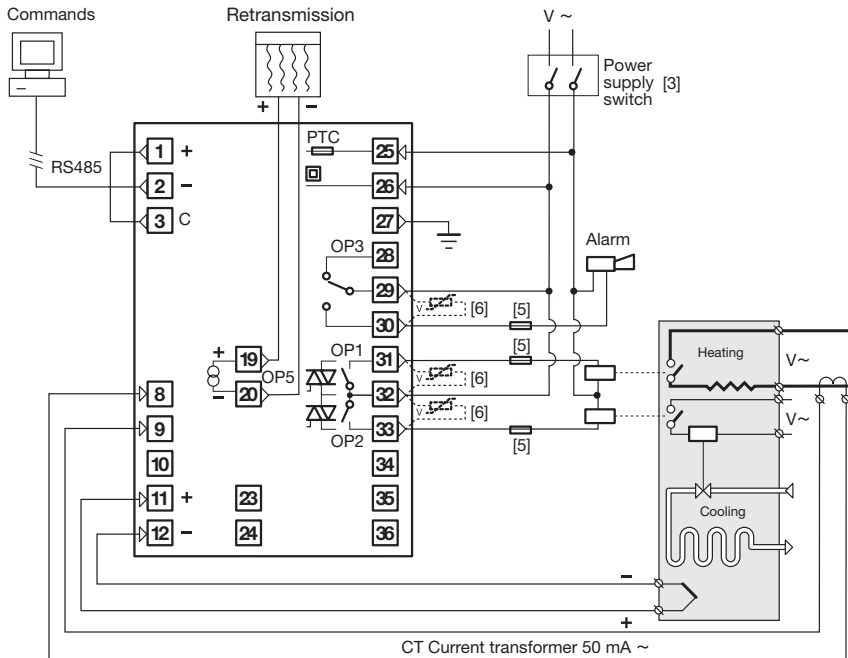
**Notes:**

- 1] Make sure that the power supply voltage is the same indicated on the instrument.
- 2] Switch on the power supply only after that all the electrical connections have been completed.
- 3] In accordance with the safety regulations, the power supply switch shall bring the identification of the relevant instrument. The power supply switch shall be easily accessible from the operator.
- 4] The instrument is PTC protected. In case of failure it is suggested to return the instrument to the manufacturer for repair.
- 5] To protect the instrument internal circuits use:
  - 2 AT fuse for Relay outputs (220 Vac);
  - 4 AT fuse for Relay outputs (110 Vac);
  - 1 AacT fuse for Triac outputs.
- 6] Relay contacts are already protected with varistors.

**Only in case of 24 Vac inductive loads, use model A51-065-30D7 varistors (on request)**

### 2.3.1 POWER SUPPLY

Switching power supply with multiple isolation and internal PTC

- **Standard version:**  
nominal voltage:  
100...240Vac (-15...+10%)  
Frequency 50/60Hz
- **Low Voltage version:**  
Nominal voltage:  
24Vac (-25...+12%)  
Frequency 50/60Hz  
or 24Vdc (-15...+25%)  
Power consumption 4W max.

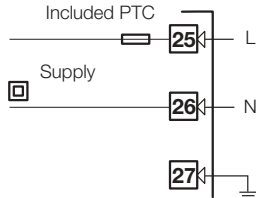

For better protection against noise, it is recommended not to connect the earth clamp provided for civilian installations.

### 2.3.2 PV CONTROL INPUT

#### A L-J-K-S-R-T-B-N-E-W thermocouple type

- Connect the wires with the polarity as shown
- Use always compensation cable of the correct type for the thermocouple used
- The shield, if present, must be connected to a proper earth.

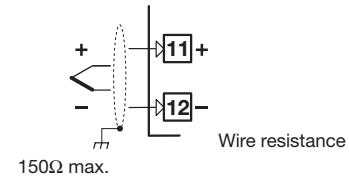

#### B For Pt100 resistance thermometer

- If a 3 wires system is used, use always cables of the same section (1mm<sup>2</sup> min.) (line 20 Ω/lead maximum resistance)
- When using a 2 wires system, use always cables of the same diameter (1,5mm<sup>2</sup> min.) and put a jumper between terminals 11 and 12

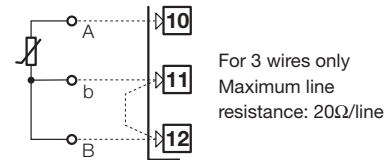

#### C For ΔT (2x RTD Pt100) Special

- ⚠ When the distance between the controller and the sensor is 15 m using a cable of 1.5 mm<sup>2</sup> section, produces an error on the measure of 1°C.

**R1 + R2 must be <320Ω**

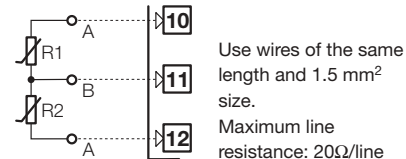

## 2.3.2 PV CONTROL INPUT

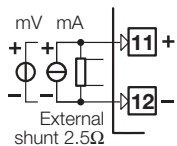

## D For mA, mV

 $R_j > 10M\Omega$ 

## D1 With 2 wires transmitter

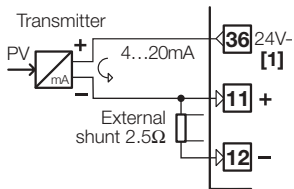

## D2 With 3 wires transmitter

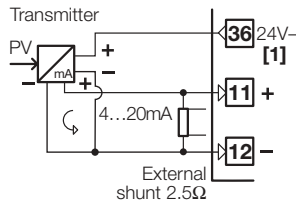

[1] Auxiliary power supply for external transmitter 24Vdc  $\pm 20\%$ /30mA max. with no short-circuit protection

## 2.3.3 AUXILIARY INPUT



## A - From Remote Setpoint (option)

Current 0/4...20mA  
Input resistance = 30Ω

Voltage  
1...5V, 0...5V, 0...10V  
Input resistance = 300kΩ

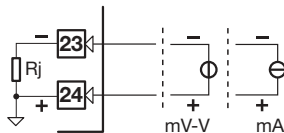

## B- For Current Transformer CT not isolated

For the measure of the load current (see page 45)

- Primary coil 10A...100A
- Secondary coil 50mA default 100mA **S3** internal jumper selectable

5 watt burden resistor  
0.5Ω for 1A secondary transformer coil  
0.1Ω for 5A secondary transformer coil

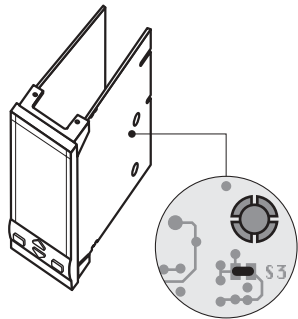
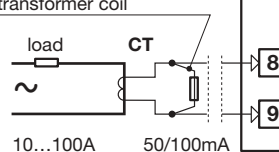

Jumper for 100 mA secondary transformer coil



### 2.3.5 OP1 - OP2 - OP3 - OP4 - OP5 OUTPUTS (OPTION)

The functionality associated to each of the OP1, OP2 and OP3 output is defined during the configuration of the instrument index

**N** (see page 19).

The suggested combinations are:

|          |               | Control outputs |      | Alarms |     |     | Retransmission |
|----------|---------------|-----------------|------|--------|-----|-----|----------------|
|          |               | Heat            | Cool | AL1    | AL2 | AL3 | PV / SP        |
| <b>A</b> | Single action | OP1             |      |        | OP2 | OP3 | OP5            |
| <b>B</b> |               | OP4             |      | OP1    | OP2 | OP3 | OP5            |
| <b>C</b> | Double action | OP1             | OP2  |        |     | OP3 | OP5            |
| <b>D</b> |               | OP1             | OP4  |        | OP2 | OP3 | OP5            |
| <b>E</b> |               | OP4             | OP2  | OP1    |     | OP3 | OP5            |

where:

|                  |                                   |
|------------------|-----------------------------------|
| <b>OP1 - OP2</b> | Relay or Triac output             |
| <b>OP3</b>       | Relay output (for AL3 only)       |
| <b>OP4</b>       | SSR drive control or Relay output |
| <b>OP5</b>       | Retransmission analogue output    |

### 2.3.5-A SINGLE ACTION RELAY (TRIAC) CONTROL OUTPUT

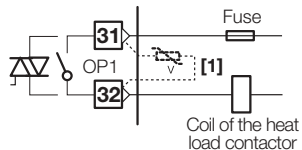

### 2.3.5-C SINGLE ACTION ANALOGUE OUTPUT

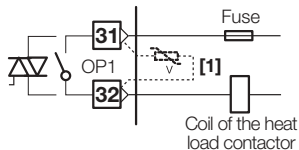

### 2.3.5-B SINGLE ACTION SSR DRIVE CONTROL OUTPUT

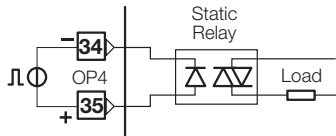

### 2.3.5-D DOUBLE ACTION RELAY (TRIAC)/RELAY (TRIAC) CONTROL OUTPUT

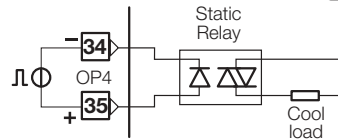
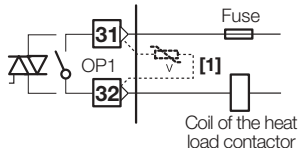

#### Relay output

- SPST Relay N.O., 2A/250 Vac (4A/120Vac) for resistive load;
- Fuse 2AT at 250Vac, 4AT at 110Vac.

#### Logic output not isolated

- 0...5Vdc,  $\pm 20\%$ , 30 mA max.

### 2.3.5-E DOUBLE ACTION RELAY (TRIAC)/SSR DRIVE CONTROL OUTPUT

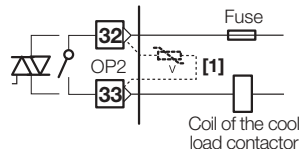
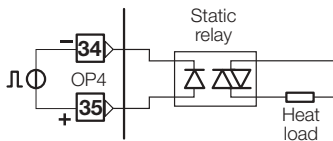

## 2.3.6 ALARM OUTPUTS



⚠ The relay/triac output OP1, OP2 and OP3, can be used as alarm outputs only if they are not used as control outputs.

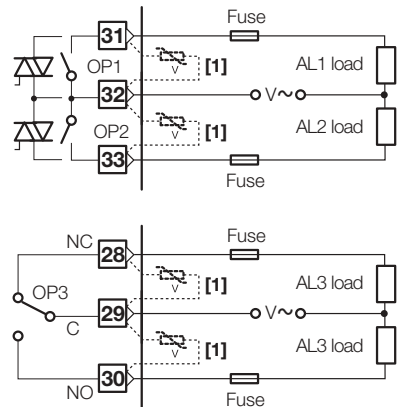

[1] Varistor for inductive load 24Vdc only

## 2.3.7 OP5 ANALOGUE RETRANSMISSION OUTPUT (OPTION)

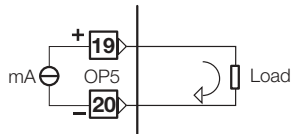

For PV/SP retransmission only:

- Galvanic isolation 500Vac/1 min
- 0/4...20mA, (750Ω or 15Vdc max.)

⚠ Please, read: **gammadue**® and **deltadue**® controller series serial communication and configuration

## 2.3.8 SERIAL COMMUNICATIONS (OPTION)

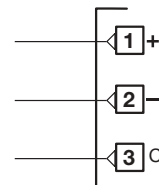

- Galvanic isolation 500Vdc/1 min  
Compliance to the EIA RS485 standard for Modbus/Jbus
- Setting dip switches

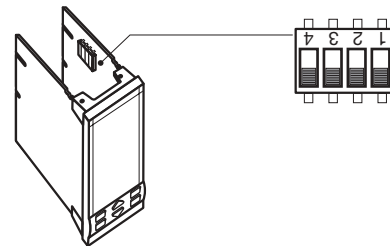



## 3 PRODUCT CODING

The complete code is shown on the instrument label. The informations about product coding are accessible from the front panel by mean of a particular procedure described at section 5.2 page 47

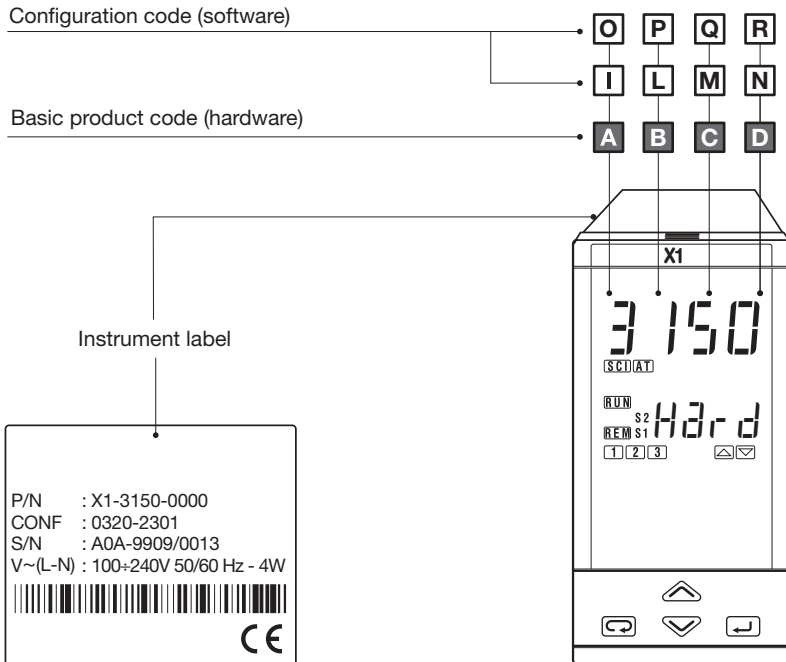

### 3.1 MODEL CODE

The product code indicates the specific hardware configuration of the instrument, that can be modified by specialized engineers only.

| Mod.: | Line | Basic   | Accessories | Configuration |       |          |     |
|-------|------|---------|-------------|---------------|-------|----------|-----|
|       |      |         |             | 1st part      |       | 2nd part |     |
|       | X 1  | A B C D | E F G 0     | I             | L M N | O P      | Q R |

|             |     |
|-------------|-----|
| <b>Line</b> | X 1 |
|-------------|-----|

|  |   |
|--|---|
| <b>Power supply</b>                      | A |
| 100...240Vac (-15...+10%)                | 3 |
| 24Vac (-25...+12%) or 24Vdc (-15...+25%) | 5 |

|                               |   |
|-------------------------------|---|
| <b>Outputs OP1 - OP2- OP4</b> | B |
| Relay - Relay - SSR Drive     | 1 |
| Triac - Triac - SSR Drive     | 5 |
| Relay - Relay - Relay         | 9 |

|                              |   |
|------------------------------|---|
| <b>Serial Communications</b> | C |
| None                         | 0 |
| RS485 Modbus/Jbus SLAVE      | 5 |

|  |   |
|--|---|
| <b>Options</b>                                 | D |
| None   | 0 |
| Retransmission output + Remote Set point input | 5 |

|                         |   |
|-------------------------|---|
| <b>Special function</b> | E |
| Not fitted              | 0 |
| Start-up + Timer        | 2 |

|                       |   |
|-----------------------|---|
| <b>User manual</b>    | F |
| Italian/English (std) | 0 |
| French/English        | 1 |
| German/English        | 2 |
| Spanish/English       | 3 |

|                           |   |
|---------------------------|---|
| <b>Front panel colour</b> | G |
| Dark (std)                | 0 |
| Beige                     | 1 |

### 3.2 CONFIGURATION CODING

A 4+4 index code follows the model of the controller.

The code has to be set to configure the controller (see chapter 3.1 page 17)

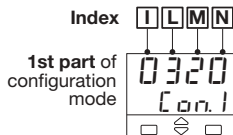

E.g. Enter the code 0320 to choose:

- T/C type J input with range 0...600°C
- Single P.I.D. control algorithm, reverse action
- Relay output

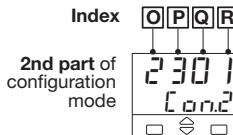

E.g. Enter the code 2301 to choose:

- AL1 absolute, active high
- AL2 absolute, active low
- AL3 Used by Timer
- Local + 2 Stored Setpoints with tracking function

| Input type and range          |                       |                  | I | L |
|-------------------------------|-----------------------|------------------|---|---|
| TR Pt100 IEC751               | -99.9...300.0 °C      | -99.9...572.0 °F | 0 | 0 |
| TR Pt100 IEC751               | -200...600 °C         | -328...1112 °F   | 0 | 1 |
| TC L Fe-Const DIN43710        | 0...600 °C            | 32...1112 °F     | 0 | 2 |
| TC J Fe-Cu45% Ni IEC584       | 0...600 °C            | 32...1112 °F     | 0 | 3 |
| TC T Cu-CuNi                  | -200 ...400 °C        | -328...752 °F    | 0 | 4 |
| TC K Chromel-Alumel IEC584    | 0...1200 °C           | 32...2192 °F     | 0 | 5 |
| TC S Pt10%Rh-Pt IEC584        | 0...1600 °C           | 32...2912 °F     | 0 | 6 |
| TC R Pt13%Rh-Pt IEC584        | 0...1600 °C           | 32...2912 °F     | 0 | 7 |
| TC B Pt30%Rh<br>Pt6%Rh IEC584 | 0...1800 °C           | 32...3272 °F     | 0 | 8 |
| TC N Nichrosil-Nisil IEC584   | 0...1200 °C           | 32...2192 °F     | 0 | 9 |
| TC E Ni10%Cr-CuNi IEC584      | 0...600 °C            | 32...1112 °F     | 1 | 0 |
| TC Ni-NiMo18%                 | 0...1100 °C           | 32...2012 °F     | 1 | 1 |
| TC W3%Re-W25%Re               | 0...2000 °C           | 32...3632 °F     | 1 | 2 |
| TC W5%Re-W26%Re               | 0...2000 °C           | 32...3632 °F     | 1 | 3 |
| Dc input 0...50mV linear      | Engineering and units |                  | 1 | 4 |
| Dc input 10...50mV linear     | Engineering and units |                  | 1 | 5 |
| Custom input and range [1]    |                       |                  | 1 | 6 |

[1] For instance, other thermocouples types,  $\Delta T$  (with 2 PT 100), custom linearisation etc.

| Engineering and units        |                       | M |
|------------------------------|-----------------------|---|
| ON-OFF reverse action        |                       | 0 |
| ON-OFF direct action         |                       | 1 |
| P.I.D. single reverse action |                       | 2 |
| P.I.D. single direct action  |                       | 3 |
| P.I.D. double action         | Linear cool output    | 4 |
|                              | ON-OFF cool output    | 5 |
|                              | Water cool output [2] | 6 |
|                              | Oil cool output [2]   | 7 |

| Output configuration     |                    |  | N |
|--------------------------|--------------------|--|---|
| Single action            | Double action      |  |   |
| Relay (OP1)              | Heat OP1, Cool OP2 |  | 0 |
| SSR drive or relay (OP4) | Heat OP1, Cool OP4 |  | 1 |
| -                        | Heat OP4, Cool OP2 |  | 2 |

- [2] In consideration of the thermal characteristics of the different cooling liquids, 2 different correcting methods of the control output are available. One for water and the other for oil

$$OP \text{ water} = 100 \cdot (OP2/100)^2$$

$$OP \text{ oil} = 100 \cdot (OP2/100)^{1.5}$$

- [3] Only possible whether "Output configuration" [N] = 0 or 1) and H.E.F.S. parameter is different to OFF, see page 29)

| Alarm 1 type and function           |                                | O |
|-------------------------------------|--------------------------------|---|
| Disabled                            |                                | 0 |
| Sensor break/Loop break alarm (LBA) |                                | 1 |
| Absolute                            | active high                    | 2 |
|                                     | active low                     | 3 |
| Deviation                           | active high                    | 4 |
|                                     | active low                     | 5 |
| Band                                | active out                     | 6 |
|                                     | active in                      | 7 |
| Heater break by CT [3]              | active during ON output state  | 8 |
|                                     | active during OFF output state | 9 |

| Alarm 2 type and function           |                                | P |
|-------------------------------------|--------------------------------|---|
| Disabled                            |                                | 0 |
| Sensor break/Loop break alarm (LBA) |                                | 1 |
| Absolute                            | active high                    | 2 |
|                                     | active low                     | 3 |
| Deviation                           | active high                    | 4 |
|                                     | active low                     | 5 |
| Band                                | active out                     | 6 |
|                                     | active in                      | 7 |
| Heater break by CT [3]              | active during ON output state  | 8 |
|                                     | active during OFF output state | 9 |

### 3 - Product coding

| <b>Alarm 3 type and function</b>    |                                | <b>Q</b> |
|-------------------------------------|--------------------------------|----------|
| Disabled or used by Timer           |                                | <b>0</b> |
| Sensor break/Loop break alarm (LBA) |                                | <b>1</b> |
| Absolute                            | active high                    | <b>2</b> |
|                                     | active low                     | <b>3</b> |
| Deviation                           | active high                    | <b>4</b> |
|                                     | active low                     | <b>5</b> |
| Band                                | active low                     | <b>6</b> |
|                                     | active in                      | <b>7</b> |
| Heater break<br>by CT <b>[3]</b>    | active during ON output state  | <b>8</b> |
|                                     | active during OFF output state | <b>9</b> |

| <b>Setpoint type</b>                  |  | <b>R</b> |
|---------------------------------------|--|----------|
| Local only                            |  | <b>0</b> |
| Local and 2 tracking stored Setpoints |  | <b>1</b> |
| Local and 2 Stand-by stored Setpoints |  | <b>2</b> |
| Local and Remote                      |  | <b>3</b> |
| Local with trim                       |  | <b>4</b> |
| Remote with trim                      |  | <b>5</b> |

## 4 OPERATIONS

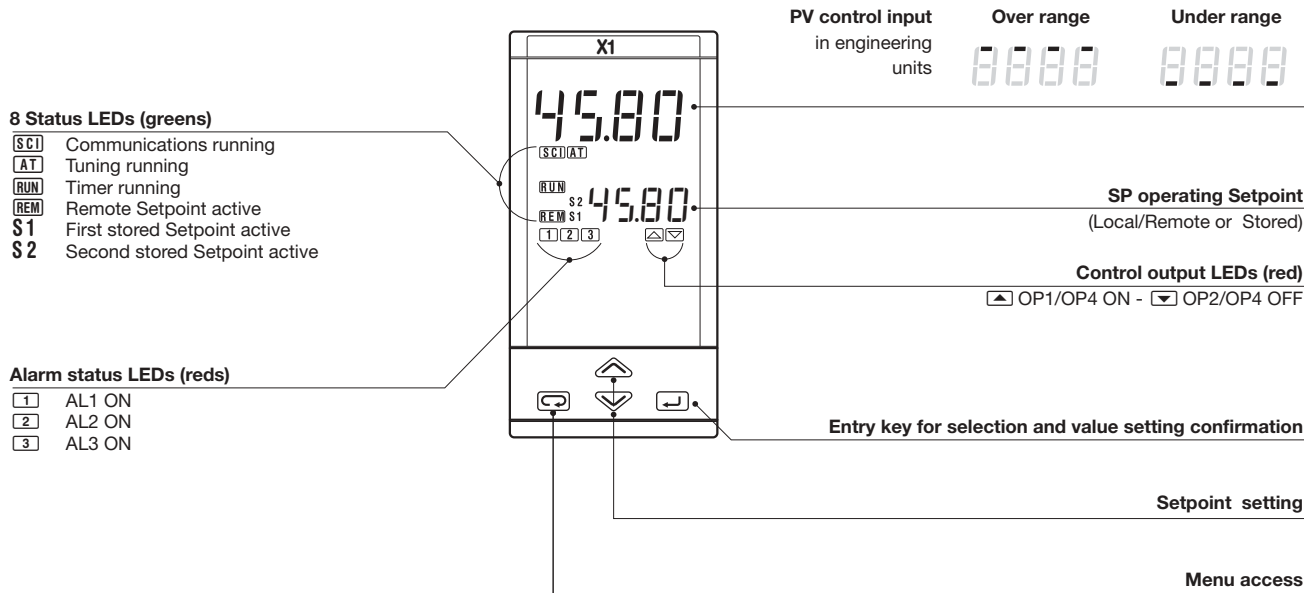

### 4.1.1 KEYS FUNCTIONS AND DISPLAY IN OPERATOR MODE





### 4.1.2 KEYS FUNCTIONS AND DISPLAY IN PROGRAMMING MODE



The parameter setting procedure has a timeout. If no keys are pressed for, at least, 30 seconds, the controller switches back, automatically, to the operator mode.

After having selected the parameter or the code, press  and  to display or modify the value (see page 23)

The value is entered when the next parameter is selected, by pressing the  key.

Until the  or  are pressed or if you wait for 30 seconds the parameter value is not inserted

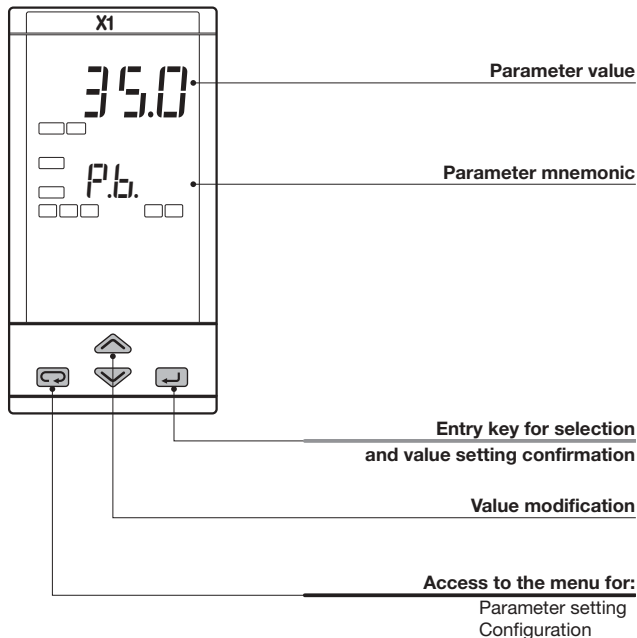

Pressing the  key, the next group of parameters is presented on the display.





## 4.2 PARAMETER SETTING

### 4.2.1 NUMERIC ENTRY

(i.e. the modification of the Setpoint value from 275.0 to 240.0)

Press  or  momentarily to change the value of 1 unit every push

Continued pressing of  or  changes the value, at rate that doubles every second. Releasing the button the rate of change decreases.

In any case the change of the value stops when it has reached the max./min limit set for the parameter.



In case of Setpoint modification: press  or  once to display the local Setpoint instead of working Setpoint.

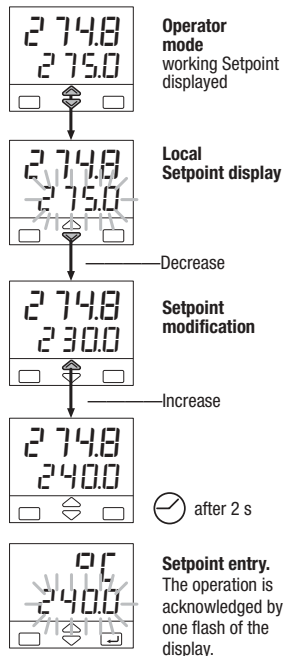

To evidence this change the display flashes once. Then the Setpoint can be modified



### 4.2.2 MNEMONIC CODES SETTING

(e.g. configuration see page 28)

Press the  or  to display the next or previous mnemonic for the selected parameter.

Continued pressing of  or  will display further mnemonics at a rate of one mnemonic every 0.5 s. The mnemonic displayed at the time the next parameter is selected, is the one stored in the parameter.

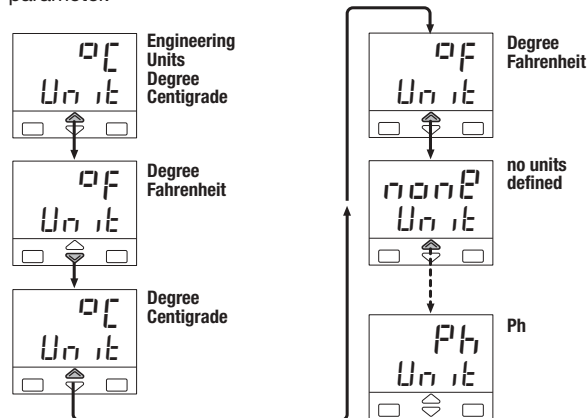



## 4.3 PARAMETERISATION - MAIN MENU

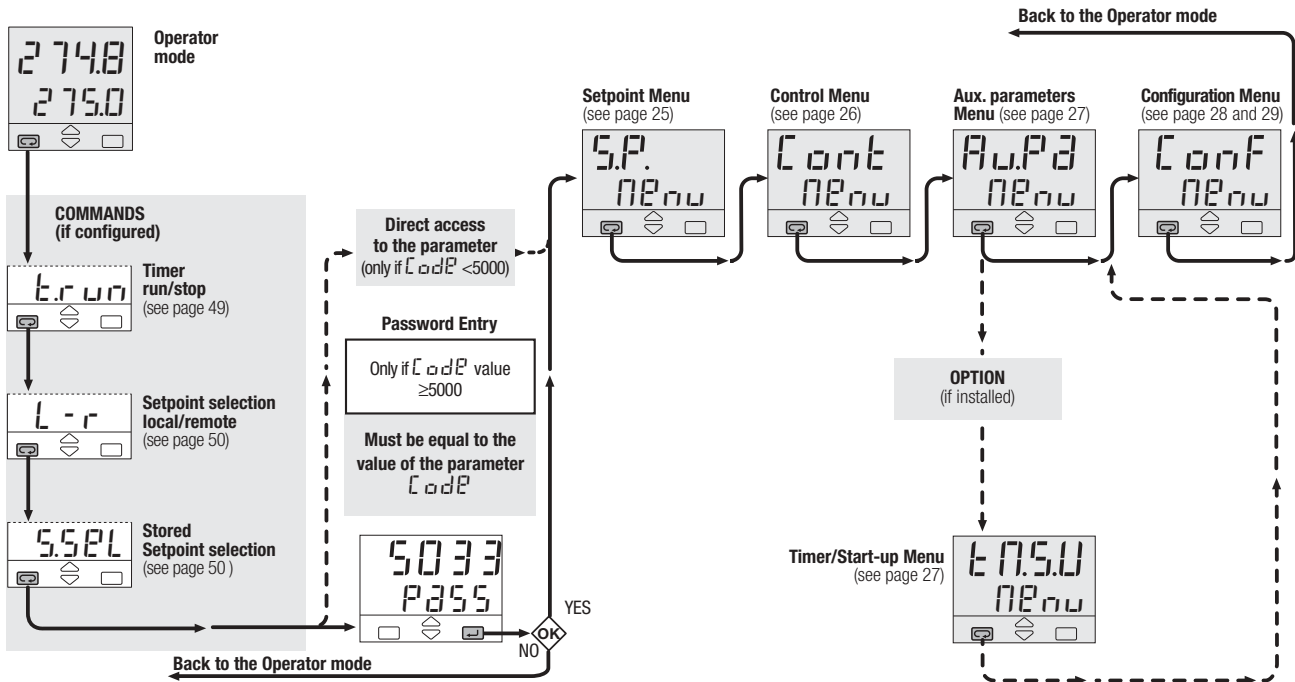

## 4.3.1 PARAMETERISATION - SETPOINT MENU

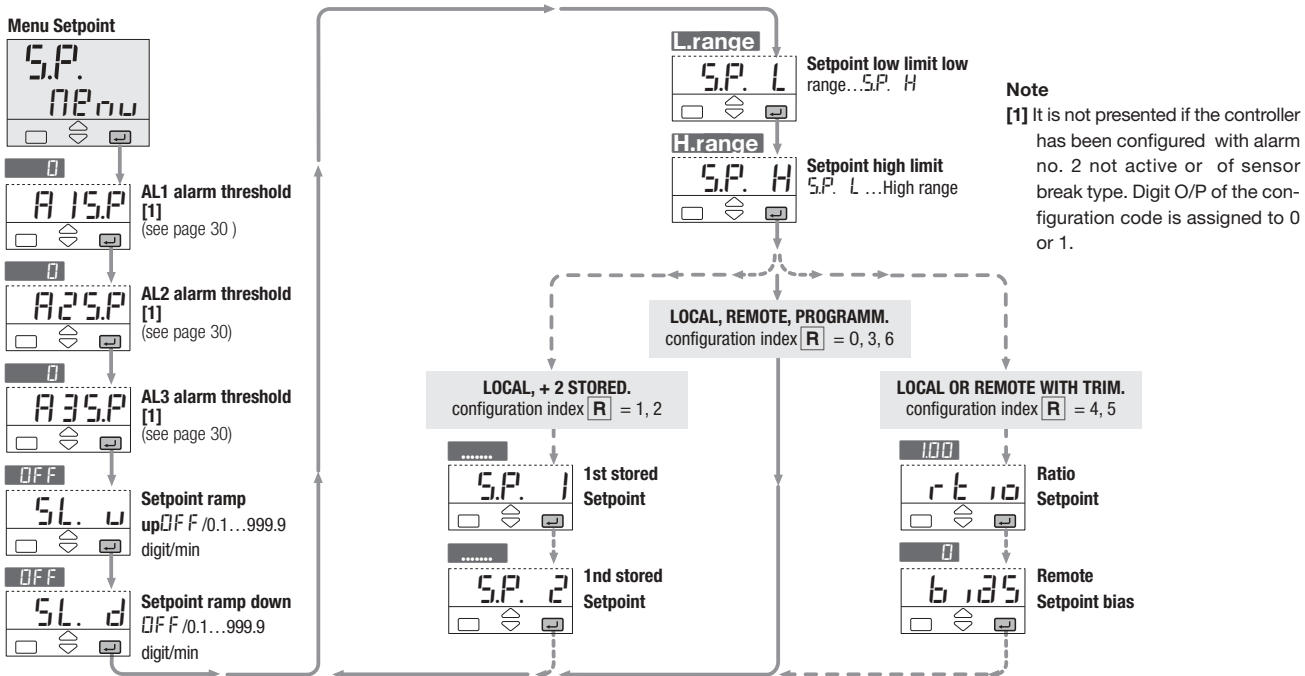

## 4.3.2 PARAMETERISATION - CONTROL MENU

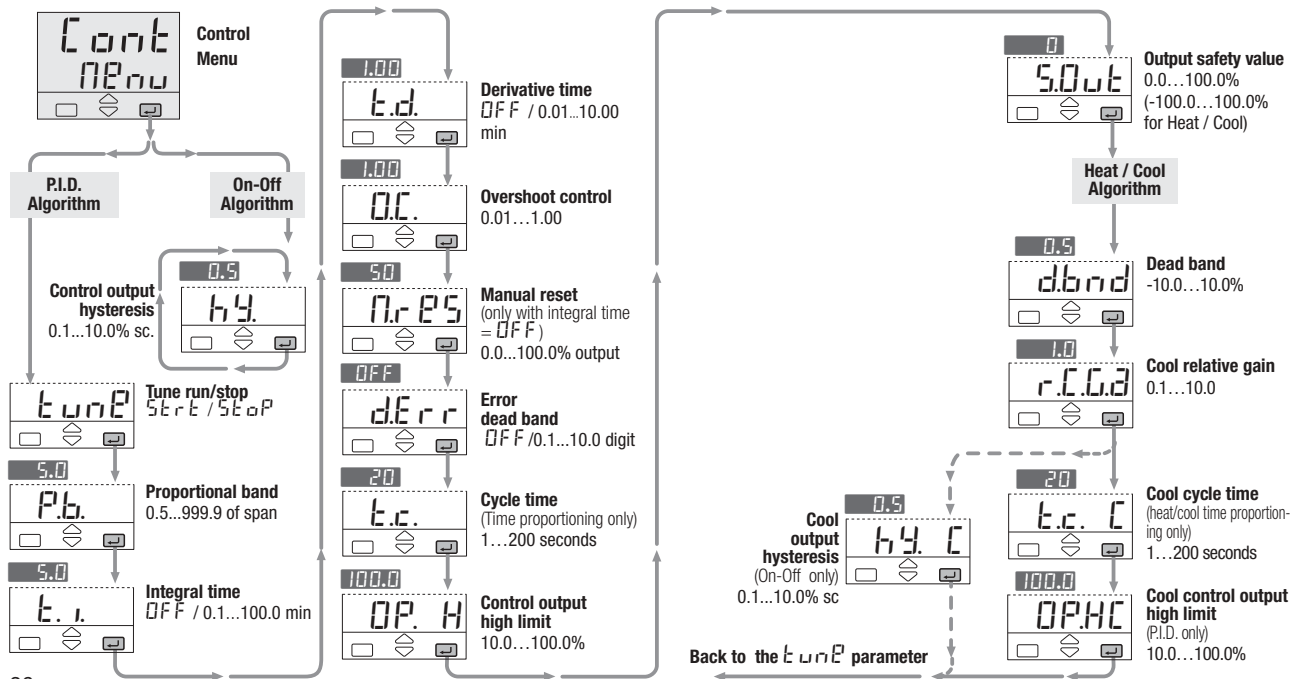

## 4.3.3 PARAMETERISATION - AUXILIARY PARAMETERS MENU

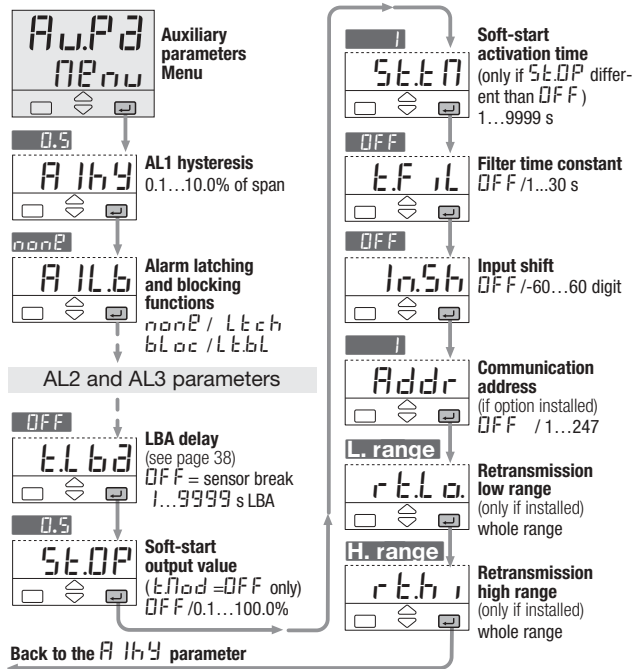

## 4.3.4 PARAMETERISATION - TIMER AND START-UP MENU

If options installed

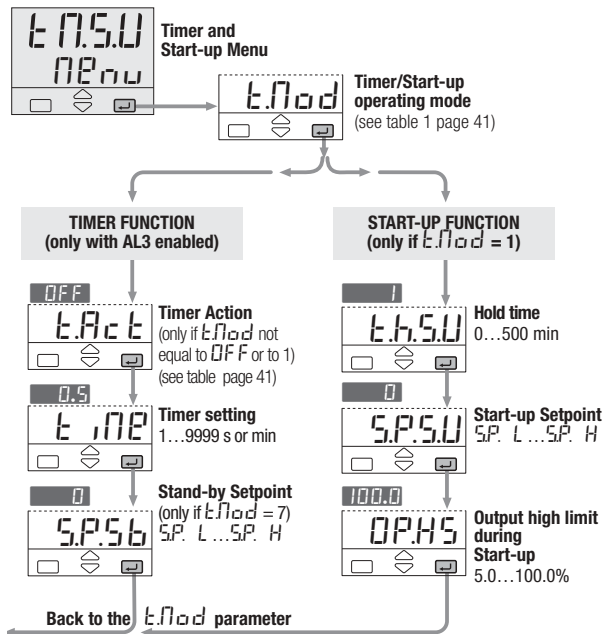

## 4.3.5 CONFIGURATION MENU

Enter the password before accessing the configuration menu.

If a not configured controller is supplied, when powered up for the first time, the display shows:

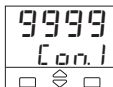

Until the configuration code is set correctly, the controller remains in stand-by with input and output deactivated.

**A 4+4 index code follows the model of the controller. It has to be set to configure the controller. (see chapter 3.1 page 17)**

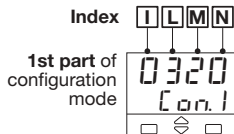

E.g. Enter the code 0320 to choose:

- T/C type J input with range 0...600°C
- Single P.I.D. control algorithm , reverse action
- Relay output

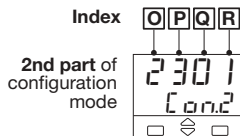

E.g. Enter the code 2301 to choose:

- AL1 absolute, active high
- AL2 absolute, active low
- AL3 Used by Timer
- Local + 2 Stored Setpoints with Tracking function



## Password Entry

Only if `Code` value <5000  
(33 default from factory)

Must be equal to the value of the parameter `Code`



Back to Operator mode

NO YES

OK



Entry of digits I - L - M - N of the configuration code (chapter 3.2 pages 18, 19)



Entry of digits O - P - Q - R of the configuration code (chapter 3.2 pages 19, 20)

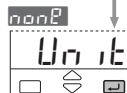

IL1 digital input function (see table 1)

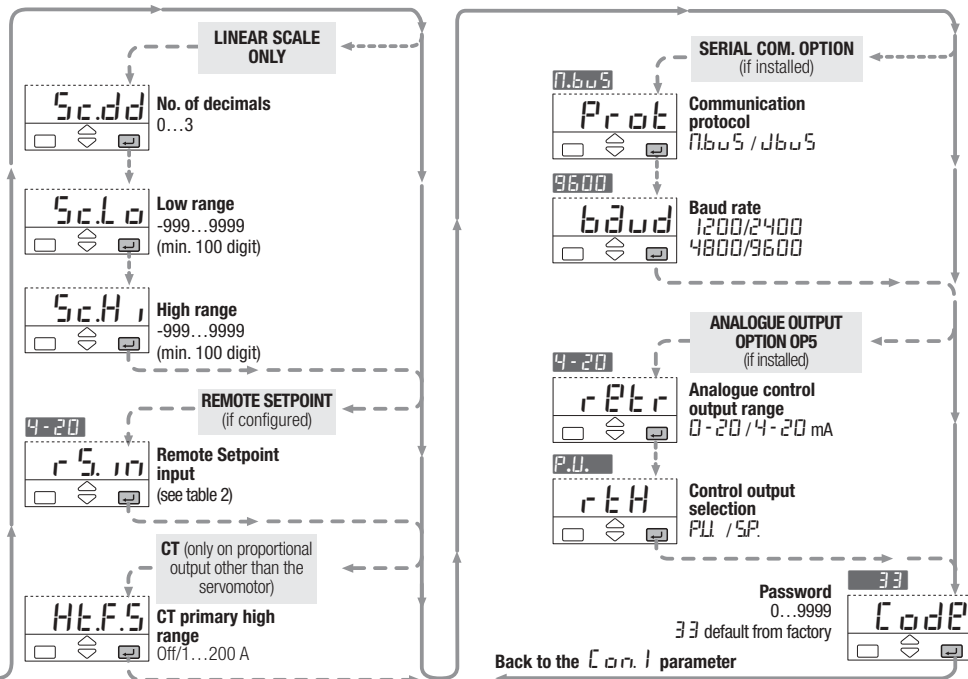

**Table 1 Engineering units**

| Value       | Description       |
|-------------|-------------------|
| $^{\circ}C$ | degree centigrade |
| $^{\circ}F$ | degree Fahrenheit |
| none        | none              |
| mV          | mV                |
| V           | Volt              |
| mA          | mA                |
| A           | Ampere            |
| bar         | Bar               |
| PSI         | PSI               |
| Rh          | Rh                |
| pH          | pH                |

**Table 2 Remote Setpoint input type**

| Value | Description |
|-------|-------------|
| 0-5   | 0...5 Volt  |
| 1-5   | 1...5 Volt  |
| 0-10  | 0...10 Volt |
| 0-20  | 0...20 mA   |
| 4-20  | 4...20 mA   |

## 4.4 PARAMETERS

For a simpler use of the controller, its parameters have been organised in groups (menu), according to their functionality area.

### 4.4.1 SETPOINT MENU

**The OP1, OP2 or OP3 outputs, can be used for alarms if they are not used as control outputs**

It is possible to configure up to 4 alarms: AL1, AL2, AL3, AL4 (see page 19 and 20), selecting, for each of them:

- A** the type and the operating condition of the alarm
- B** the functionality of the alarm acknowledge (latching)     (see page 37)
- C** the start-up disabling (blocking)     (see page 37)
- D** Loop break or sensor break (see page 38)

### A ALARM TYPE AND OPERATION CONDITIONS

#### Absolute alarm (full scale)

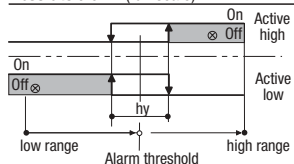

#### Deviation alarm

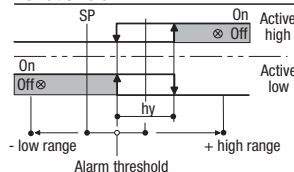

#### Band alarm

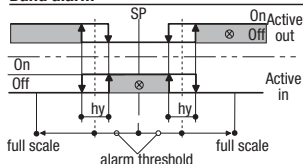

A 15.P

**AL1 alarm threshold**

A 25.P

**AL2 alarm threshold**

A 35.P

**AL3 alarm threshold**

Alarm occurrences of OP1, OP2 and OP3 outputs, respectively linked to AL1, AL2 and AL3.

The range of the alarm threshold correspond to the whole span and it is not limited by the SP Setpoint span.

When the event occurs, the display will show the red leds   , respectively on.

**SL. u****Setpoint  
ramp up****SL. d****Setpoint  
ramp down**

This parameter specifies the maximum rate of change of the Setpoint in digit/min.

**When the parameter is OFF, this function is disabled and the new Setpoint is reached immediately after being entered.**

Otherwise, the Setpoint value is reached according to the configured rate of change.

The new Setpoint value is called "Target Setpoint". It can be displayed by means the parameter **ES.P.** (see procedure at page 47).

When Remote Setpoint is configured, we suggest to disable **SL. u** and **SL. d** parameters **OFF**.

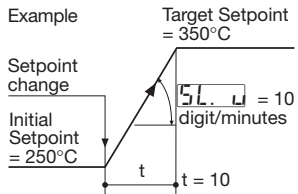
**S.P. L****Setpoint  
low limit****S.P. H****Setpoint  
high limit**

Low / high limit of the Setpoint value.

**S.P. 1****1st stored  
Setpoint****S.P. 2****2nd stored  
Setpoint**

Preset Set values can be set from the keyboard and serial communication. The Setpoint active is indicated by the **S1** or **S2** green led.

If index **R** = 1 (tracking), the previous Local Setpoint value will be lost, when the stored Setpoint is selected.

If index **R** = 2 (Stand-by), the Local Setpoint value will not be lost, when the Stand-by Setpoint is selected. It will operate again when back to Local.

See stored Setpoint selection procedure at page 50



## 4.4.1 SETPOINT MENU

r t 10

**Remote Setpoint Ratio**

Ratio is the coeff. which defines the remote Setpoint span with respect to the input span.

b 125

**Remote Setpoint**

Bias defines the starting point of analogue Remote Setpoint in eng. units corresponding to the low limit (current or voltage) of the remote signal.

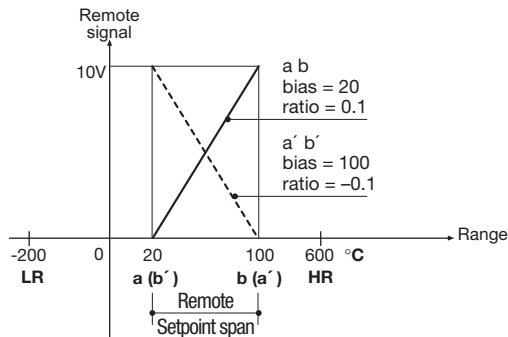
**Remote Setpoint Bias and Ratio**

PV = process variable  
 LR = PV low limit  
 HR = PV high limit  
 SR = Remote Setpoint  
 $a(a)$  = SR starting point  
 $b(b)$  = SR ending point

If SR starting point is **lower** then the ending point, both expressed in engineering units:

$b$  is starting point =  $a$

$$r t 10 = \frac{b - a}{HR - LR}$$

Example:

$b$  is 20

$r t 10 =$

$$\frac{100 - 20}{600 - (-200)} = \frac{80}{800} = 0.1$$

If SR starting point is **higher** then the ending point, both expressed in engineering units

$b_{i\Delta 5}$  = starting point =  $a'$

$$r_{t\ 10} = \frac{b' - a'}{HR - LR}$$

Example:

$b_{i\Delta 5} = 100$

$$r_{t\ 10} = \frac{20 - 100}{600 - (-200)} = \frac{-80}{800} = -0.1$$

**Working Setpoint (SP) as combination of Local Setpoint (SL) and remote signal**

Setpoint type  $L_{oc.t}$   
(configuration index  $\boxed{R} = 4$ )  
 $SP = SL + (r_{t\ 10} \bullet REM)$   
 $+ b_{i\Delta 5}$

Setpoint type  $r_{E}n.t$   
(configuration index  $\boxed{R} = 5$ )  
 $SP = REM + (r_{t\ 10} \bullet SL)$   
 $+ b_{i\Delta 5}$

SIGN = Remote signal  
percentage

SPAN = HR-LR

$$REM = \frac{SIGN \bullet SPAN}{100}$$

Examples:

Local Setpoint (SL) with an external Trim with multiplying coefficient of 1/10:

Setpoint type =  $L_{oc.t}$

$r_{t\ 10} = 0.1$

$b_{i\Delta 5} = 0$

Remote Setpoint (SR) with an internal Trim with multiplying coefficient of 1/5:

Setpoint type =  $r_{E}n.t$

$r_{t\ 10} = 0.2$

$b_{i\Delta 5} = 0$

Remote Setpoint range equal to the Input range:

Setpoint type =  $L_{oc.t}$

$r_{t\ 10} = 1$

$b_{i\Delta 5} = LR$

$SL = 0$

## 4.4.2 CONTROL MENU

**tune** Run  
Tune

## 4.4.2.1 AUTOMATIC TUNE

The **Fuzzy-Tuning** determines automatically the best P.I.D. term with respect to the process behaviour.

The controller provides 2 types of “one shot” tuning algorithm, that are selected automatically according to the process condition when the operation is started.

This type is selected when, at

## STEP response

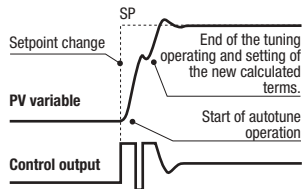

the start of the autotune operation, the PV is far from the Setpoint of more than 5% of the span. This method has the big advantage of fast calculation, with a reasonable accuracy in the term calculation.

## Natural frequency

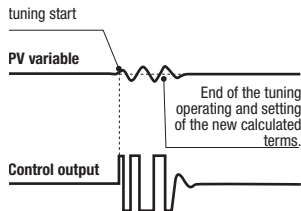

This type is selected when the PV is close to the SP Setpoint. This method has the advantage of a better accuracy in the term calculation with a reasonable speed calculation.

The **Fuzzy Tuning** determines automatically the best method to use to calculate the P.I.D. term, according to the process conditions.

## FUZZY-TUNING START/STOP PROCEDURE

**Start/stop of the Fuzzy Tuning**  
The Tuning operation can be started or stopped any time.

The green led **[AT]** is ON when the Fuzzy Tuning is in progress. At the end of this operation, the calculated P.I.D. terms parameter are stored and used by the control algorithm and the controller goes back to the operator mode. The green led **[AT]** becomes off.

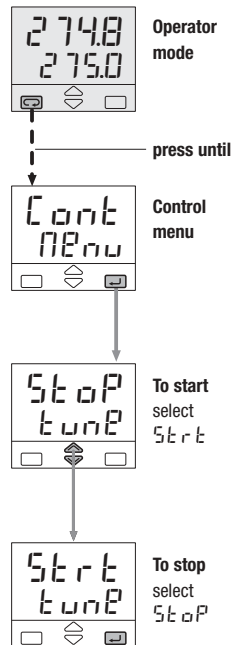

**P.b.** Proportional band

This parameter specifies the proportional band coefficient that multiplies the error (SP - PV)

**I. t.** Integral time

It is the integral time value, that specifies the time required by the integral term to generate an output equivalent to the proportional term. When **OFF** the integral term is not included in the control algorithm.

**t.d.** Derivative time

It is the time required by the proportional term P to repeat the output provided by the derivative term D. When **OFF** the derivative term is not included in the control algorithm.

**O.C.** Overshoot control

This parameter specifies the span of action of the overshoot control. Setting lower values (1.00 → 0.01) the overshoot generated by a Setpoint change is reduced. The overshoot control doesn't affect the effectiveness of the P.I.D. algorithm. Setting 1, the overshoot control is disabled.

**M.r. P.S.** Manual Reset

This specifies the control output value when PV = SP, in a PD only algorithm (lack of the integral term).

**d.e.r.r.** Error Dead Band

Inside this band for (PV - SP), the control output does not change to protect the actuator (output Stand-by)

**t.c.** Control output cycle time**t.c. C** Cool cycle time

It's the cycle time of the SSR drive control output. The P.I.D. control output is provided by the pulse width modulation of the waveform.

**O.P. H** Control output high limit**O.P.C.H** Cool output high limit

It specifies the maximum value the control output can be set. It is applied in manual mode, too.

**S.O.u.t** Output Safety Value

Output Value in case of input anomaly

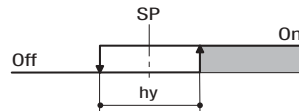
**h.y.** Control output hysteresis**h.y. C** Cool output hysteresis

Control or alarm output hysteresis span, set in % of the full scale.

## 4.4.2 CONTROL MENU

### 4.4.2.2 HEAT/COOL CONTROL

By a sole P.I.D. control algorithm, the controller handles two different outputs, one of these performs the Heat action, the other one the Cool action.

**It is possible to overlap the outputs.**

The dead band parameter  $\boxed{dbnd}$  is the zone where it is possible to separate or overlap the Heat and Cool actions.

The Cool action can be adjusted using the relative cool gain parameter  $\boxed{r.c.g.a.}$

To limit the Heat and Cool outputs the parameters  $\boxed{OP.H}$  and  $\boxed{OP.HC}$  can be used.

When there is an overlap, the displayed output  $\boxed{OUT}$  shows the algebraic sum of the Heat and Cool outputs.

#### A Heat /Cool actions separated

Insert positive  $\boxed{dbnd}$  value (0...10%)

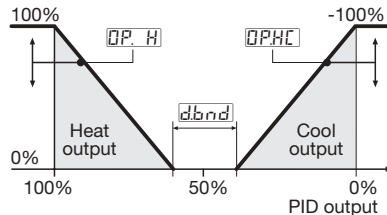

#### B Heat /Cool actions overlapped

Insert negative  $\boxed{dbnd}$  value (-10...0%)

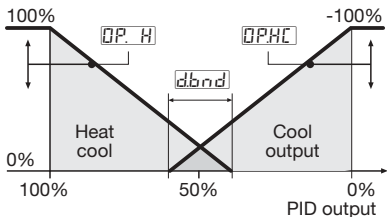

#### C Cool action adjusting

Example with different relative cool gains

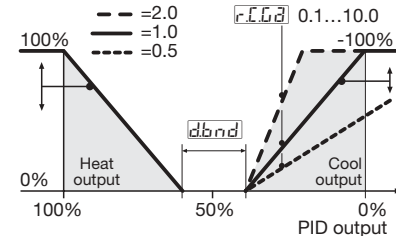

#### D On-Off Cool action

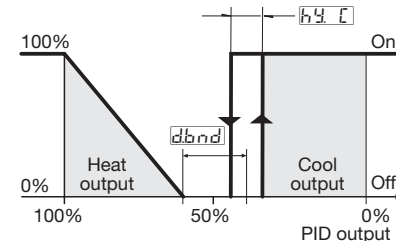

## 4.4.3 AUXILIARY PARAMETERS MENU

A169

AL1  
alarm hysteresis

A269

AL2  
alarm hysteresis

A369

AL3  
alarm hysteresis

Hysteresis of the threshold of both the alarms, that activate OP1 and OP2 control output. It is specified as a % of the full scale.

A1L6

AL1, AL2, AL3  
latching

A2L6

and  
blocking

A3L6

functions

For each alarm it is possible to select the following functions

none  
 Latching  
 blocking  
 both latching  
 and blocking

Latching

ALARM

ACKNOWLEDGE FUNCTION

The alarm, once occurred, is presented on the display until to the time of acknowledge. The acknowledge operation consists in pressing any key.

**After this operation, the alarm leaves the alarm state only when the alarm condition is no longer present.**

blocking

START-UP DISABLING

Ramp down

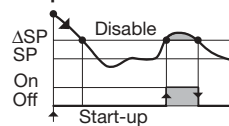

Ramp up

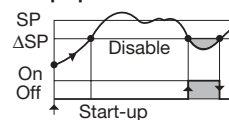
 $\Delta SP$  Threshold =  $SP \pm \text{range}$

## 4.4.3 AUXILIARY PARAMETERS MENU

ALARMS WITH LBA (LOOP BREAK ALARM)  
AND SENSOR BREAK OPERATION

Select the code 1 on **O** , **P** or **Q** configuration indexes (see pages 21 or 22). The following parameter is then available:

**EL63** LBA delay

Setting a value between 1 and 9999 s the alarm works as LBA+Sensor break with delay [1]

This condition is shown by means a red led as well as the blinking PV display.

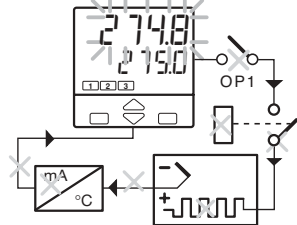

Setting OFF the alarm works as Sensor break with immediate action.

This condition is shown by means the red led of the selected alarm as well as:

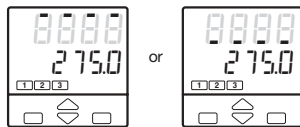

**Note [1]** In case of sensor break, condition, the alarm action is immediate.

When the cause of the alarm disappears, the alarm status stops.

**SE.OP** Soft-start control output value

Value of the control output during the Soft-start activation time.

**SE.EN** Soft-start activation time

Time duration (starting from the power on) of the Soft-start function.

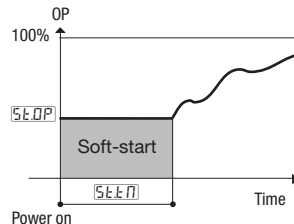
**EF.IL** Input filter time constant

Time constant, in seconds, of the RC input filter applied to the PV input.

When this parameter is set to OFF the filter is bypassed.

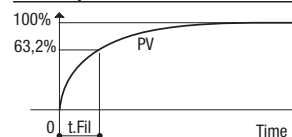
**Filter response****1n.5h** Input shift

This value is added to the measured PV input value. Its effect is to shift the whole PV scale of up to  $\pm 60$  digits.

**Addr****Controller address**

the address range is from 1 to 247 and must be unique for each controller on the communication bus to the supervisor.

When set to **OFF** the controller is not communicating

**rELo****Retransmission low range****rEH****Retransmission high range****4.4.4 TIMER AND START-UP MENU (OPTION)**

To improve the instrument performances and to reduce the wiring and installation costs, two special functions are available:

**4.4.4.1 Start-up****4.4.4.2 Timer**

In order to have the above functions the product code digit **E** must be **2** (see page 19)

For example: X3 3100-2000

To select these functions use the parameter: (see page 41).

**t.NoD** **Timer/Start-up operator mode**

**⚠ Selecting Timer or Start-up, the Soft-start function is disabled, therefore the parameters **SEOP** and **SEEN** will not be shown.** (see page 29)

**4.4.4.1 START-UP FUNCTION (OPTION)**

By means of this function it is possible to manipulate the control output when the controller is switched on.



To configure Start-up function the parameter

“Timer/Start-up operating mode” must be set to  (see page 41)

Three parameters are associated to the Start-up function.

**t.h.SU**

**Start-up hold time**  
0...500 min

**SP.SU**

**Start-up Setpoint**  
(SP. L...SP. H)

**OPHS**

**Control output high limit**  
5.0%...100.0%

The Start-up function includes three phases:

1<sup>st</sup> “Limy” - The control output is limited to the **OPHS**

2<sup>nd</sup> “Hold” - The process variable is maintained to the Start-up Setpoint for the time fixed by the parameter **t.h.SU**

3<sup>rd</sup> “Off” - When the **t.h.SU** time is elapsed the process variable is maintained to the working Setpoint.

Whether the process variable, for any reason (e.g. load change), decreases at a value lower than (**SP.SU** - 40 digits), the Start-up function starts again from the “Limy” phase.



#### 4.4.4.1 START-UP FUNCTION (OPTION)

When the Start-up is in Hold phase, if the local Setpoint becomes lower than the Start-up Setpoint or if the operating mode changes to manual, the Start-up function passes to the "Off" phase.

There are two possibilities:

**A Start-up Setpoint  $SP_{SU}$  lower than the local Setpoint.**

The "Hold" phase starts when the process variable PV achieves the  $SP_{SU}$  (with a tolerance of 1 digit).

**B Start-up Setpoint  $SP_{SU}$  greater than or equal to the local Setpoint.**

When the process variable PV achieves the local Setpoint (with a tolerance of 1 digit), the Start-up function passes directly to the "Off" phase.

If, at the controller power-on, the process variable PV is greater than the lowest between the  $SP_{SU}$  and the working Setpoint, the next phase ("Hold" or "Off") will be executed instead of the "Limy" phase.



Start-up Setpoint

During the "Limy" and "Hold" phases the **RUN** led is on.

#### A $SP_{SU} < \text{local Setpoint SP}$

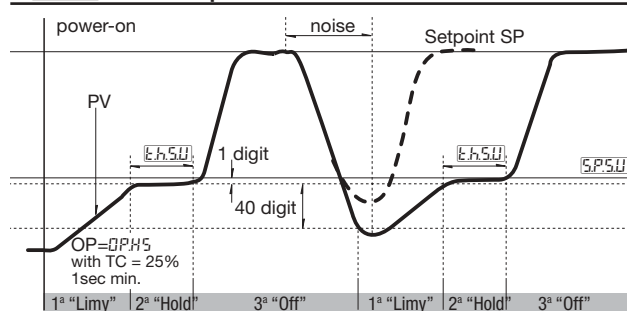

#### B $SP_{SU} \geq \text{Setpoint locale SP}$

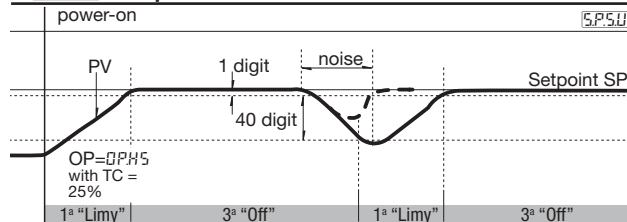

## 4.4.4.2 TIMER FUNCTION (OPTION)

**⚠ The Timer can't be enabled with Heat / Cool control.**

To enable this function do the following:

- 1 In order to use this AL3 function, index **Q** must be set to **1** in configuration (see p. 20).
- 2 To select one of the 6 possible functioning modes of the Timer, set the value of the 2 following parameters in parameterisation (see p. 27).

### **t.No d** Timer/Start-up operating mode

By this parameter can be defined: (see table 1)

- the counting start time
- the control output status at the end of the counting

**table 1**

| Timer/Start-up counting mode    |              | Value |
|---------------------------------|--------------|-------|
| Disabled                        |              | 0FF   |
| Start-up function               |              | 1     |
| Counting start time             | End mode     |       |
| When inside the band            | Control mode | 2     |
|                                 | Output to 0  | 3     |
| When launched                   | Control mode | 4     |
|                                 | Output to 0  | 5     |
| When launched. Control disabled | Control mod  | 6     |
|                                 | Control mod  | 7     |

Now the other parameter values can be entered:

### **t.Ac t** Timer Action

By this parameter can be defined:(see table 2)

- the time units
- the starting mode
- the OP3 status when the timer is running.

When the timer is not running, the OP3 takes the opposite status.

**table 2**

| Time units | Starting mode            | [1] OP3 status | Value |
|------------|--------------------------|----------------|-------|
| Seconds    | Manual by keypad         | On             | 0     |
|            |                          | Off            | 1     |
|            | Auto at the power on [2] | On             | 2     |
|            |                          | Off            | 3     |
| Minutes    | Manual by keypad         | On             | 4     |
|            |                          | Off            | 5     |
|            | Auto at the power on [2] | On             | 6     |
|            |                          | Off            | 7     |

[1] If used by Timer

[2] Using this selection, manual starting mode is possible too.

### **t.in e** Timer setting

(1...9999 s/min)

### **S.P.56** Stand-by Setpoint

(only for **t.No d** = 7)  
(S.P. L...S.P. H)

## 4.4.4.2 TIMER FUNCTION (OPTION)

## TIMER COUNTING MODES

**A - Counting start time inside the band, end in control mode.**

The time counting starts only when the error is inside a  $\pm 1$  digit band. The control action is not affected by the Timer function.

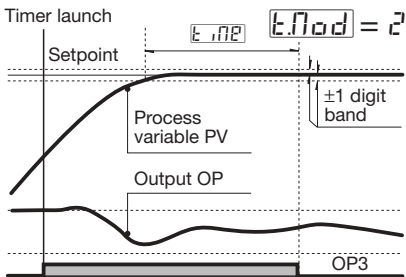
**B - Counting start time inside the band, end with control output forced to zero.**

The time counting starts only when the error is inside a  $\pm 1$  digit band. At the end, the control output is forced to zero. [1]

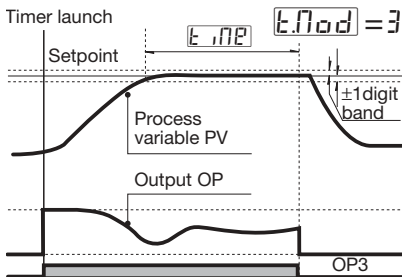
**C - Counting start time = timer launch time, end in control mode.**

The time counting starts when the timer is launched. The control action is not affected by the Timer function.

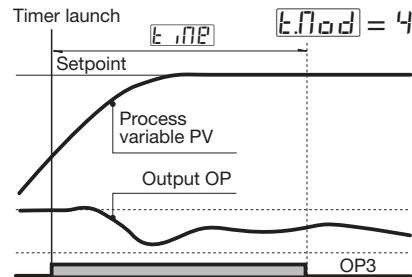

[1] When the Timer is not running the control output is forced to zero, also before the Timer launch

## TIMER COUNTING MODES

### D - Counting start time = timer launch time, end with control output forced to zero.

The time counting starts when the timer is launched. At the end, the control output is forced to zero [1].

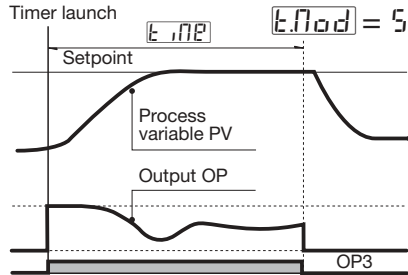

[1] When the Timer is not running the control output is forced to zero, also before the Timer launch

### E - No control action during the counting time.

The time counting starts when the timer is launched and the control output is forced to zero. At the end, the control action starts.

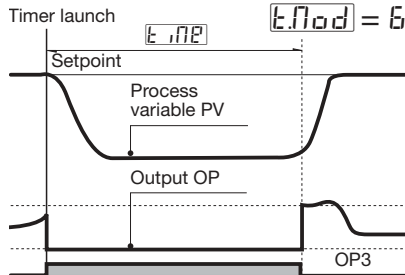

### F - Control action with stand-by Setpoint during the counting time

The time counting starts when the timer is launched and the control action use the Stand-by Setpoint. At the end, the control action use the working Setpoint.

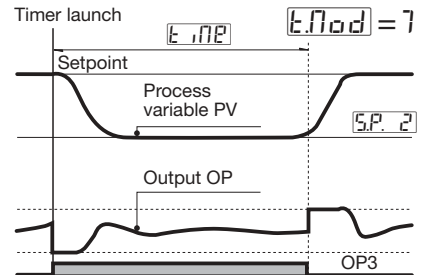

## 4.4.4.2 TIMER FUNCTION (OPTION)

## POWER FAILURE

If there is a power failure during the Timer execution, the value of the elapsed time is lost.

Depending on Timer action **End** selection, when the controller restarts you can have two different situations:

- with automatic mode (**End** = 2, 3, 6, 7), the Timer function starts again and the counting time is reinitialised.
- with manual mode (**End** = 0, 1, 4, 5), the control output is forced to zero, if **End** = 3 e 5; otherwise the control action restarts using the working Setpoint

## TIMER STARTING

See the Timer starting procedure at page 49.

## DISPLAY

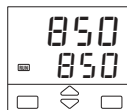

When the Timer is running, the led **RUN** is on.



When the Timer ends, the Setpoint display shows alternatively the message **End** and the Setpoint value until a key is pressed.

## TIMER REMAINING TIME

When the timer is running it is always possible to see the remaining time and to modify it.

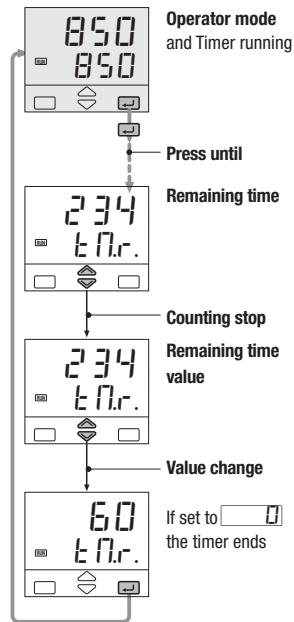

## 4.4.5 CONFIGURATION MENU

### RETRANSMISSION

When OP5 output is present, it retransmits linearised PV or SP. On configuration (see page 29) it is possible to set

**retr**

**Output range**

0-20 / 4-20

**reth**

**Retransmitted signal**

nonP / PU / SP

The following parameters define the low and high range of the OP5 retransmission output corresponding to 0...4mA or 20mA (see page 27):

**relo**

**Retransmission low range**

**rehi**

**Retransmission high range**

Example:

- T/C S, range 0...1600°C
- Output range, 4...20 mA
- Retransmitted signal PV on 800...1200°C range

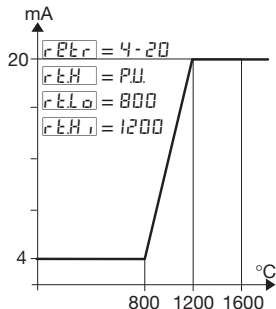

With **relo** greater than **rehi**, it is possible to obtain a reverse scale.

### CURRENT TRANSFORMER INPUT

With CT option, it is possible to display the load current and set an alarm threshold.

The setting can be done by means of the 8 or 9 configuration index of the codes O, P or Q (see pages 19 and 20).

It is possible to set one of the alarms (see pages 19 and 20) to have an alarm when, during the ON time of the time proportional output, the load current is less than the specified threshold (index 8), or during the OFF time there is a value > 3% of full scale load current.

The alarm condition must be longer than 120 ms to set the alarm.

By the parameter

**HEFS**

**CT primary high range**

OFF / 1...200A

the load current display can be adapted to the transformer characteristics. (OFF means disabled)

During the OFF time the parameter **ECur** latches the last on time current value

## 4.4.5 CONFIGURATION MENU

## CURRENT TRANSFORMER INPUT

## Example:

CT input on OP1, alarm on AL2 during on time (configuration digit

**P** = 8, , see page 19)

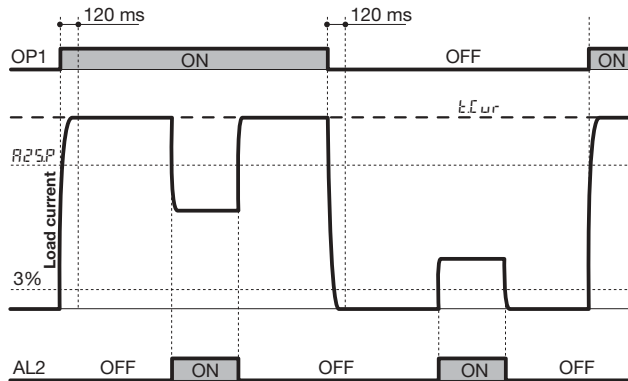

## SERIAL COMMUNICATIONS

**Prot** Communication  
protocol  
RS485/RS485

**baud** Baud rate  
1200/2400  
4800/9600

## 5

## DISPLAYS

## 5.1 OF THE PROCESS VARIABLES

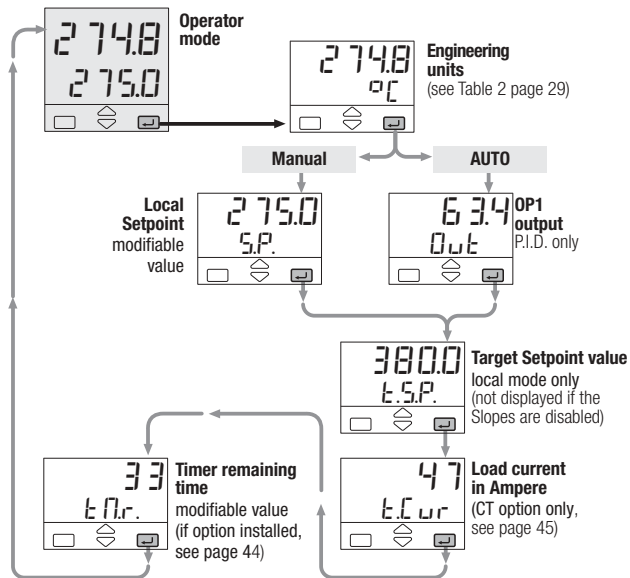

## 5.2 OF THE CONFIGURATION CODES

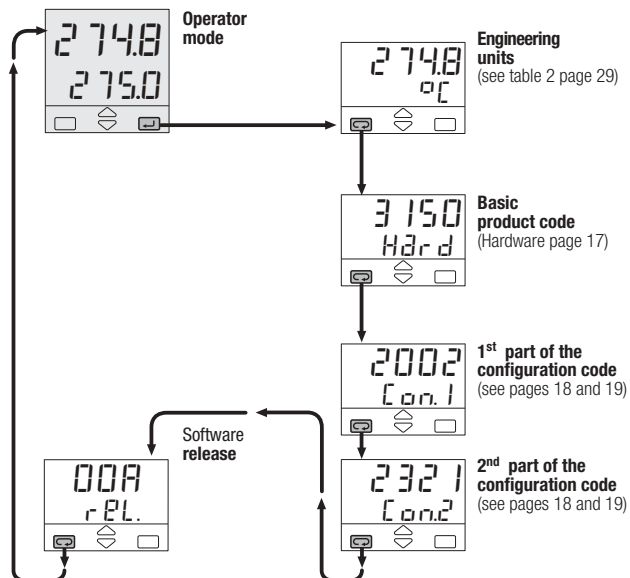



# 6 COMMANDS

## COMMANDS TO THE CONTROLLER AND OPERATING PHASES

The commands can be entered in 2 ways:



### 6.1 KEYPAD

see page 49

- Setpoint modification
- Timer start
- Local/remote selection
- Stored Setpoint display
- Keypad lock
- Outputs lock

### 6.2 SERIAL COMMUNICATIONS

see the manual on this topic



## 6.1 KEYPAD COMMANDS

### 6.1.1 SETPOINT MODIFICATION

The Setpoint is directly modified with the   keys.

Once entered, the new value is checked and becomes operating after 2 seconds.. The end of this phase is flagged by flashing momentarily the display with SP.

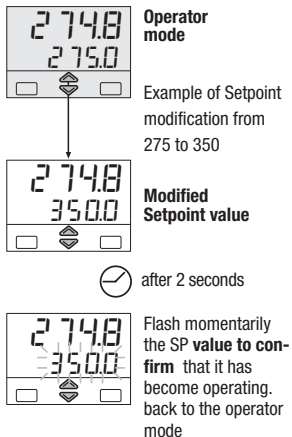

### 6.1.2 TIMER STARTING (option)

Depending on the Timer action E.a.c.t selection, there can be two different starting ways:

- Automatic at the power on
- Manual by keypad, digital inputs or serial communications.

To start/stop the Timer:

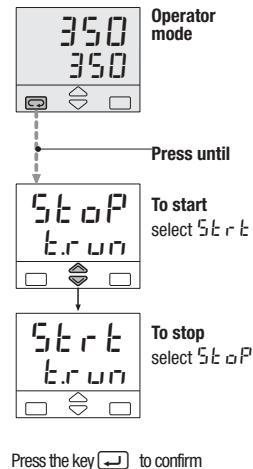

## 6.1 KEYPAD COMMANDS

### 6.1.3 LOC/ REM SELECTION

configuration index  $\boxed{R}$  = 4 or 5)

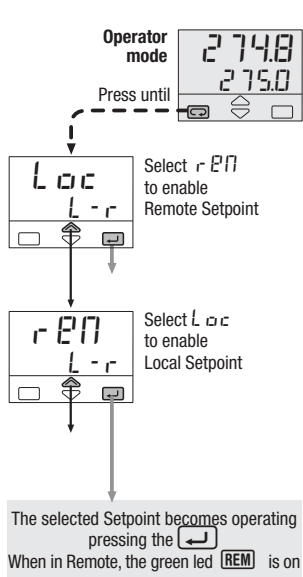

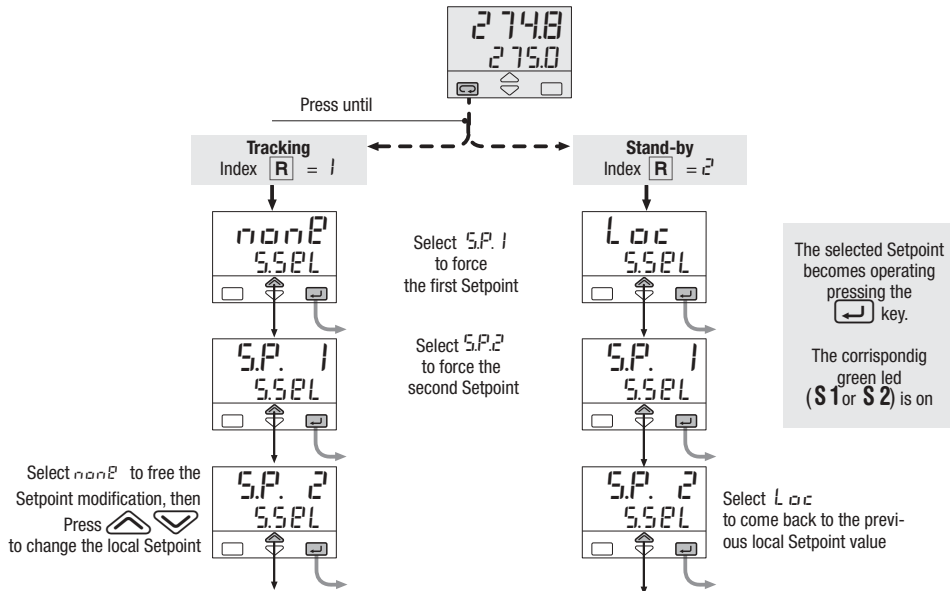

### 6.1.4 STORED SETPOINTS SELECTION

(configuration index  $\boxed{R}$  = 1 or 2)



### 6.1.5 KEYPAD LOCK

To lock/unlock the keypad press the keys  and  simultaneously for 2 seconds. To confirm the keypad lock/unlock the display flashes once.

The keypad lock/unlock can be achieved by serial communications too.

---

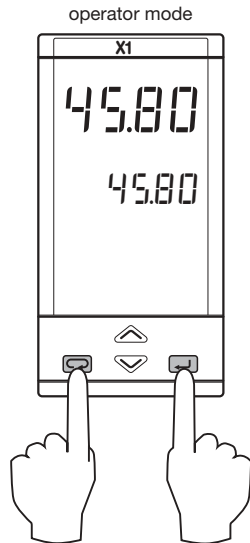

**!** The keypad lock is maintained in case of power failure.

---



Press simultaneously  
for 2 seconds

### 6.1.6 OUTPUTS LOCK

The outputs are switched to the OFF status by pressing the keys  and  together. When the outputs are locked, the message  is displayed instead of the Setpoint value. To unlock the outputs press again the keys simultaneously (the Soft-start will be enabled).

The outputs lock/unlock can be achieved by serial communications too

---

**!** The outputs lock/unlock is maintained in case of power failure.

---

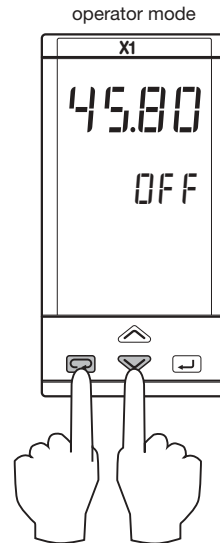

Press simultaneously  
for 2 seconds

## 7 TECHNICAL SPECIFICATIONS

| Features<br>(at 25°C environmental temp.)  | Description  |  |   |  |
|--|--|--|---|--|
| <b>Total configurability</b><br>(see chapter 3.2 page 18<br>chapter 4.3.5 page 28) | From keypad or serial communication the user selects: <ul style="list-style-type: none"> <li>- the type of input</li> <li>- the type of control algorithm</li> <li>- the type of output</li> <li>- the type and functionality of the alarms</li> <li>- the type of Setpoint</li> <li>- control parameter values</li> </ul> |  |   |  |
| <b>PV Input</b><br>(see pages 11,12 and<br>page 18)                                | Common characteristics   | A/D converter with resolution of 50000 points<br>Update measurement time: 0.2 seconds<br>Sampling time: 0.5 seconds<br>Input bias: - 60...+ 60 digit<br>Input filter with enable/disable: 1...30 seconds |   |  |
|  | Accuracy   | 0.25% ±1 digits for temperature sensors<br>0.1% ±1 digits (for mV and mA)  |   |  |
|  | Resistance thermometer<br>(for ΔT: R1+R2<br>must be <320Ω)   | Pt100Ω at 0°C<br>(IEC 751)<br>°C/°F selectable   | 2 or 3 wires<br>connection<br>Burnout<br>(with any combination)                       | Max. wire Res: 20Ω max. (3 wires)<br>Input drift: 0.35°C/10° Env. Temp.<br><0.35°C/10Ω Wire Res. |
|  | Thermocouple   | L, J, T, K, S, R, B, N, E, W3, W5<br>(IEC 584)<br>R <sub>j</sub> >10MΩ<br>°C/°F selectable   | Internal cold junction<br>compensation con NTC<br>Error 1°C/20°C ±0.5°C<br>Burnout    | Line 150Ω<br>Input drift: <2μV/°C Env. Temp.<br><5μV/10Ω Wire Res.                               |
|  | DC input (current)   | 4...20mA, 0...20mA<br>with external shunt 2.5Ω<br>R <sub>j</sub> >10MΩ   | Burnout. Engineering units<br>Conf. decimal point position<br>Init. Scale -999...9999 | Input drift: <0.1%/20°C Env. Temp.   |
| DC input (voltage)   | 10...50mV, 0...50mV<br>R <sub>j</sub> >10MΩ  | Full Scale -999...9999<br>(min. range of 100 digits)   |   |  |

| Features<br>(at 25°C environmental temp.) |   | Description                                  |  |                         |                 |                 |                 |              |              |
|---|---|--|--|-------------------------|-----------------|-----------------|-----------------|--------------|--------------|
| Auxiliary inputs                          | Remote Setpoint (option)<br>Not isolated<br>accuracy 0.1%                         | Current<br>0/4...20mA<br>Rj = 30Ω            | Bias in engineering units and ±range<br>Ratio from -9.99...+99.99<br>Local + Remote Setpoint |                         |                 |                 |                 |              |              |
|   |   | Voltage<br>1...5/0...5/0...10V<br>Rj = 300kΩ |  |                         |                 |                 |                 |              |              |
|   | CT current transformer<br>(see pages 12 and 45)                                   | 50 or 100 mA<br>input hardware<br>selectable | Current visualisation 1...200A<br>With 1A resolution<br>and Heater Break Alarm               |                         |                 |                 |                 |              |              |
| Operating mode<br>and Outputs             | 1 single or<br>double action<br>P.I.D. loop or<br>On/Off with<br>1, 2 or 3 alarms | Single<br>action                             | Control output   |                         | AL1 alarm       | AL2 alarm       | AL3 alarm       | Retransmiss. |              |
|   |   |  | OP1-Relay/Triac  |                         |                 | OP2-Relay/Triac | OP3-Relay       | OP5-Analogue |              |
|   |   | OP4-<br>SSR drive-Relay                      |  | OP1-Relay/Triac         | OP2-Relay/Triac | OP3-Relay       | OP5-Analogue    |              |              |
|   |   | Double action<br>Heat / Cool                 | OP1-Relay/Triac  | OP2-Relay/Triac         |                 |                 | OP3-Relay       | OP5-Analogue |              |
|   |   |  | OP1-Relay/Triac  | OP4-<br>SSR drive-Relay |                 |                 | OP2-Relay/Triac | OP3-Relay    | OP5-Analogue |
|   |   |  | OP4-<br>SSR drive-Relay  | OP2-Relay/Triac         | OP1-Relay/Triac |                 | OP3-Relay       | OP5-Analogue |              |

## 7 - Technical specifications

| Features<br>(at 25°C environmental temp.) | Description                         |   |                 |  |  |
|---|-------------------------------------|---|-----------------|--|--|
| <b>Control mode</b>                       | Algorithm                           | <ul style="list-style-type: none"> <li>- P.I.D. with overshoot control or ON-OFF</li> <li>- P.I.D. with valve drive algorithm, for motorised actuators control</li> </ul> |                 |  |  |
|   | Proportional band (P)               | 0.5...999.9%  |                 |  |  |
|   | Integral time (I)                   | 0.1...100.0 min   | $\Delta FF = 0$ |  |  |
|   | Derivative time (D)                 | 0.01...10.00 min  |                 |  |  |
|   | Error dead band                     | 0.1...10.0 digit  |                 |  |  |
|   | Overshoot control                   | 0.01...1.00   |                 | Single action<br>P.I.D. algorithm                                  |  |
|   | Manual reset                        | 0.0...100.0%  |                 |  |  |
|   | Cycle time (Time proportional only) | 1...200 s   |                 |  |  |
|   | Control output high limit           | 10.0...100.0%   |                 |  |  |
|   | Soft-start output value             | 0.1...100.0%  | $\Delta FF = 0$ |  |  |
|   | Output safety value                 | 0.0...100.0% (-100.0...100.0% for Heat / Cool)  |                 |  |  |
|   | Control output hysteresis           | 0.1...10.0%   |                 | On-Off algorithm   |  |
|   | Dead band                           | -10.0...10.0%   |                 | Double action<br>P.I.D. algorithm<br>(Heat / Cool)<br>with overlap |  |
|   | Relative cool gain                  | 0.1...10.0  |                 |  |  |
|   | Cycle time (Time proportional only) | 1...200 s   |                 |  |  |
|   | Control output high limit           | 10.0...100.0%   |                 |  |  |
| Cool output hysteresis                    | 0.1...10.0%                         |   |                 |  |  |

| Features<br>(at 25°C environmental temp.)            | Description  |  |   |                            |  |
|--|--|--|---|----------------------------|--|
| <b>OP1-OP2 outputs</b>                               | SPST Relay N.O., 2A/250Vac (4A/120Vac) for resistive load<br>Triac, 1A/250Vac for resistive load           |  |   |                            |  |
| <b>OP3 output</b>                                    | SPDT relay N.O., 2A/250Vac (4A/120Vac) for resistive load  |  |   |                            |  |
| <b>OP4 output</b>                                    | SSR drive not isolated: 0/5Vdc, ±10% 30mA max. - SPST Relay N.O., 2A/250Vac (4A/120Vac) for resistive load |  |   |                            |  |
| <b>OP5 analogue output</b><br>(option)               | Control or PV/SP retransmission  | Galvanic isolation: 500 Vac/1 min.<br>Resolution 12bit (0.025%)<br>Accuracy: 0.1 % | In current: 0/4...20mA, 750Ω / 15V max.   |                            |  |
| <b>AL1 - AL2 - AL3</b><br><b>alarms</b>              | Hysteresis 0.1...10.0% c.s.  |  |   |                            |  |
|  | Action   | Active high  | Action type   | Deviation threshold ±range |  |
|  |  | Active low   |   | Band threshold 0...range   |  |
|  | Special functions  | Sensor break, heater break alarm   |   |                            |  |
|  |  | Acknowledge (latching), activation inhibit (blocking)                              |   |                            |  |
| Connected to Timer or program (if options installed) |  |  |   |                            |  |
| <b>Setpoint</b>                                      | Local  |  | Up and down ramps 0.1...999.9 digit/min. (OFF=0)<br>Low limit: from low range to high limit<br>High limit: from low limit to high range |                            |  |
|  | Local  |  |   |                            |  |
|  | Local and Remote   | If option installed  |   |                            |  |
|  | Local with trim  |  |   |                            |  |
|  | Remote with trim   |  |   |                            |  |
| Remote with trim                                     |  |  |   |                            |  |



| Features<br>(at 25°C environmental temp.) | Description  |   |                           |
|---|--|---|---------------------------|
| <b>Special functions</b><br>(option)      | <b>Timer</b> (see page 41)   | Automatic start at the power on, manual start by keypad, Digital inputs or serial comm.s  |                           |
|   |  | Setting time: 1...9999 s/min  |                           |
|   |  | Stand-by Setpoint: from Setpoint low limit to Setpoint high limit   |                           |
|   | <b>Start-up</b><br>(see page 39)   | Start-up Setpoint: from Setpoint low limit to Setpoint high limit   |                           |
|   |  | Hold time: 0...500min   |                           |
| Control output high limit: 5.0...100.0%   |  |   |                           |
| <b>Fuzzy-Tuning one shoot</b>             | The controller selects automatically the best method according to the process conditions | Step response<br>Natural frequency  |                           |
| <b>Serial comm.</b> (option)              | RS485 isolated, Modbus/Jbus protocol, 1200, 2400, 4800, 9600 bit/s, 3 wires              |   |                           |
| <b>Auxiliary Supply</b>                   | +24Vdc $\pm$ 20% 30mA max. - for external transmitter supply                             |   |                           |
| <b>Operational safety</b>                 | Measure input  | Detection of out of range, short circuit or sensor break with automatic activation of the safety strategies and alerts on display |                           |
|   | Control output   | Safety value: -100...+100%  |                           |
|   | Parameters   | Parameter and configuration data are stored in a non volatile memory for an unlimited time  |                           |
| <b>General characteristics</b>            | Access protection  | Password to access the configuration and parameters data, keypad lock, outputs lock   |                           |
|   | Power supply<br>(fuse protected)   | 100/240Vac (-15...+10%) 50/60Hz or<br>24Vac (-15...+25%) 50/60Hz and 24Vdc (-15...+25%)   | Power consumption 4W max. |
|   | Safety   | Compliance to EN61010-1 (IEC 1010 – 1), installation class 2 (2.5kV) pollution class 2, <b>instrument class II</b>                |                           |
|   | Electromagnetic compatibility  | Compliance to the CE standards (see page 2)   |                           |
|   | UL and cUL approval  | File 176452   |                           |
|   | Protection   | EN60529 (IEC529): IP65 front panel  |                           |
|   | Dimensions   | 1/8 DIN - 48 x 96, depth 110 mm, weight 250 g approx.   |                           |

























## **WARRANTY**











We warrant that the products will be free from defects in material and workmanship for 18 months from the date of delivery.

The warranty above shall not apply for any failure caused by the use of the product not in line with the instructions reported on this manual.

## ICONS TABLE

| Main universal input  |                        |
|---|------------------------|
|  | Thermocouple           |
|  | RTD (Pt100)            |
|  | Delta Temp (2x RTD)    |
|  | mA and mV              |
|  | Custom                 |
|  | Frequency              |
| Auxiliary input   |                        |
|  | Current transformer    |
|  | mA Remote setpoint     |
|  | Volt Remote setpoint   |
|  | Feedback potentiometer |
|   |                        |

| Digital input   |                     |
|---|---------------------|
|  | Isolated contact    |
|  | NPN open collector  |
|  | TTL open collector  |
| Setpoint  |                     |
|  | Local               |
|  | Stand-by            |
|  | Keypad lock         |
|  | Outputs lock        |
|  | Start-up function   |
|  | Timer function      |
|  | Memorized           |
|  | Remote              |
|  | Setpoint programmer |

| Digital input connected functions   |  |
|---|--|
|  | Auto/Manual                            |
|  | Run, Hold, Reset and program selection |
|  | PV hold                                |
|  | Setpoint slopes inhibition             |
| Output  |  |
|  | SPST Relay                             |
|  | Triac                                  |
|  | SPDT Relay                             |
|  | mA                                     |
|  | mA mV                                  |
|  | SSR Drive                              |
|   |  |



