

# YASKAWA AC Drive V1000

## 1000 Hz Software

## Quick Start Guide

**Type:** CIMR-VC□B□□□□

**Models:** 200 V Class, Single-Phase Input: 0.1 to 4.0 kW  
200 V Class, Three-Phase Input: 0.1 to 15 kW  
400 V Class, Three-Phase Input: 0.2 to 15 kW

To properly use the product, read this manual thoroughly and retain for easy reference, inspection, and maintenance.  
Ensure the end user receives this manual.

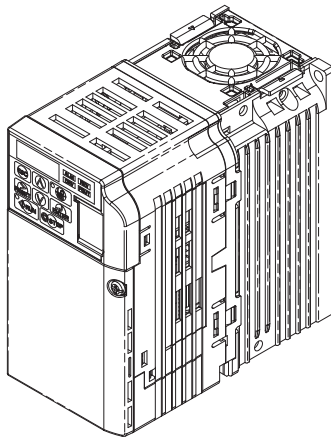

---

Copyright © 2009

YASKAWA ELECTRIC CORPORATION.

All rights reserved. No part of this publication may be reproduced, stored in a retrieval system, or transmitted, in any form, or by any means, mechanical, electronic, photocopying, recording, or otherwise, without the prior written permission of YASKAWA. No patent liability is assumed with respect to the use of the information contained herein. Moreover, because YASKAWA is constantly striving to improve its high-quality products, the information contained in this manual is subject to change without notice. Every precaution has been taken in the preparation of this manual. Nevertheless, YASKAWA assumes no responsibility for errors or omissions. Neither is any liability assumed for damages resulting from the use of the information contained in this publication.

# V1000

## Quick Start Guide

---

<b>1 Safety Instructions and General Warnings</b> . . . . .	<b>4</b>
<b>2 Mechanical Installation</b> . . . . .	<b>11</b>
<b>3 Electrical Installation</b> . . . . .	<b>14</b>
<b>4 Keypad Operation</b> . . . . .	<b>20</b>
<b>5 Modification from Standard Software</b> . . . . .	<b>22</b>
<b>6 Start Up</b> . . . . .	<b>29</b>
<b>7 Parameter Table</b> . . . . .	<b>33</b>
<b>8 Troubleshooting</b> . . . . .	<b>38</b>

# 1 Safety Instructions and General Warnings

YASKAWA supplies component parts for use in a wide variety of industrial applications. The selection and application of YASKAWA products remain the responsibility of the equipment designer or end user. YASKAWA accepts no responsibility for the way its products are incorporated into the final system design. Under no circumstances should any YASKAWA product be incorporated into any product or design as the exclusive or sole safety control. Without exception, all controls should be designed to detect faults dynamically and fail safely under all circumstances. All products designed to incorporate a component part manufactured by YASKAWA must be supplied to the end user with appropriate warnings and instructions as to the safe use and operation of that part. Any warnings provided by YASKAWA must be promptly provided to the end user. YASKAWA offers an express warranty only as to the quality of its products in conforming to standards and specifications published in the manual. **NO OTHER WARRANTY, EXPRESS OR IMPLIED, IS OFFERED.** YASKAWA assumes no liability for any personal injury, property damage, losses, or claims arising from misapplication of its products.

### ◆ Applicable Documentation

---

The following manuals are available for V1000 series drives with 1000Hz High frequency software:

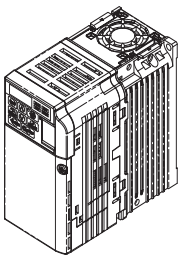
	<b>YASKAWA AC Drive V1000 Technical Manual</b>
	This manual provides detailed information on parameter settings, drive functions, and MEMOBUS/Modbus specifications. Use this manual to expand drive functionality and to take advantage of higher performance features.
	<b>YASKAWA AC Drive V1000 1000Hz Software Quick Start Guide (this book)</b>
	Read this manual first. This guide is packaged together with the product. It contains basic information required to install and wire the drive, in addition to an overview of fault diagnostics, maintenance, and parameter settings. Use the information in this book to prepare the drive for a trial run with the application and for basic operation. Additionally parameter differences between 1000Hz software and standard software are notified.

### ◆ Receiving

---

Please perform the following tasks after receiving the drive:

- Inspect the drive for damage. If the drive appears damaged upon receipt, contact your supplier.

# 1 Safety Instructions and General Warnings

- Verify receipt of all components.
- Verify receipt of the correct model by checking the information on the nameplate. If you have received the wrong model contact your supplier.

## ■ Drive Model Identification

V1000 Series drives with 1000Hz Software have a different model code as standard V1000 drives.

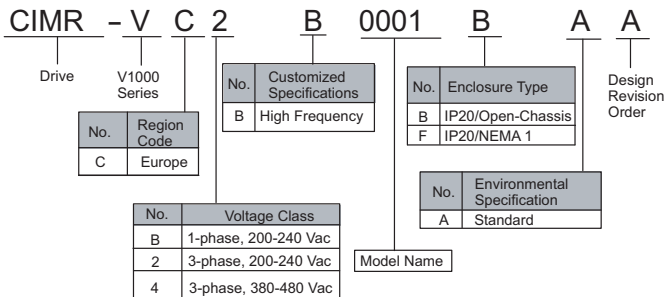

## ■ Nameplate

Drives software number shown on the nameplate must be “503□”.

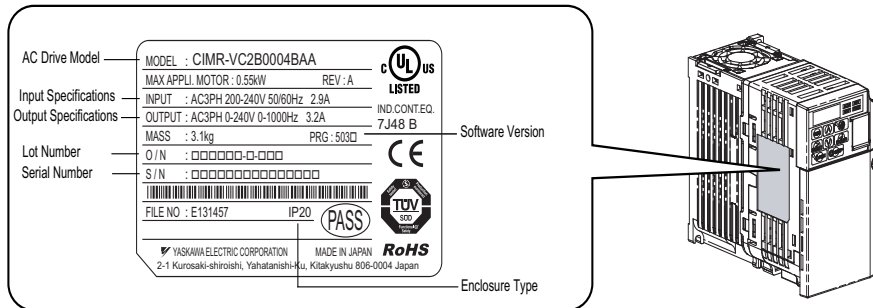

# 1 Safety Instructions and General Warnings

---

## ◆ General Warnings

---

 <b>WARNING</b>	
<ul style="list-style-type: none"><li>• <b>Read and understand this manual before installing, operating or servicing this drive.</b></li><li>• <b>All warnings, cautions, and instructions must be followed.</b></li><li>• <b>All work must be performed by qualified personnel.</b></li><li>• <b>The drive must be installed according to this manual and local codes.</b></li></ul>	
<ul style="list-style-type: none"><li>• <b>Heed the safety messages in this manual.</b> The operating company is responsible for any injuries or equipment damage resulting from failure to heed the warnings in this manual.</li></ul>	

 <b>WARNING</b>	
Indicates a hazardous situation, which, if not avoided, could result in death or serious injury.	

The following conventions are used to indicate Safety messages in this manual:

 <b>CAUTION</b>	
Indicates a hazardous situation, which, if not avoided, could result in minor or moderate injury.	

<b>NOTICE</b>	
Indicates a property damage message.	

## ◆ Safety Warnings

---

 <b>WARNING</b>	
<b>Electrical Shock Hazard</b>	
<ul style="list-style-type: none"><li>• <b>Do not attempt to modify or alter the drive in any way not explained in this manual.</b> Failure to comply could result in death or serious injury. YASKAWA is not responsible for any modification of the product made by the user. This product must not be modified.</li></ul>	
<ul style="list-style-type: none"><li>• <b>Do not touch any terminals before the capacitors have fully discharged.</b> Failure to comply could result in death or serious injury. Before wiring terminals, disconnect all power to the equipment. The internal capacitor remains charged even after the power supply is turned off. The charge indicator LED will extinguish when the DC bus voltage is below 50 VDC. To prevent electric shock, wait at least five minutes after all indicators are off and measure the DC bus voltage level to confirm safe level.</li></ul>	

# 1 Safety Instructions and General Warnings

## WARNING

- **Do not allow unqualified personnel to use equipment.**  
Failure to comply could result in death or serious injury.  
Maintenance, inspection, and replacement of parts must be performed only by authorized personnel familiar with installation, adjustment, and maintenance of AC drives.
- **Do not remove covers or touch circuit boards while the power is on.**  
Failure to comply could result in death or serious injury.
- **Always ground the motor-side grounding terminal.**  
Improper equipment grounding could result in death or serious injury by contacting the motor case.
- **Do not perform work on the drive while wearing loose clothing, jewelry or without eye protection.**  
Failure to comply could result in death or serious injury.  
Remove all metal objects such as watches and rings, secure loose clothing, and wear eye protection before beginning work on the drive.
- **Never short the output circuits of the drive.**  
Do not short the output circuits of the drive. Failure to comply could result in death or serious injury.
- **System may start unexpectedly upon application of power, resulting in death or serious injury.**  
Clear all personnel from the drive, motor, and machine area before applying power. Secure covers, couplings, shaft keys, and machine loads before applying power to the drive.

## WARNING

### Fire Hazard

- **Do not use an improper voltage source.**  
Failure to comply could result in death or serious injury by fire.  
Verify that the rated voltage of the drive matches the voltage of the incoming power supply before applying power.
- **Do not use improper combustible materials.**  
Failure to comply could result in death or serious injury by fire.  
Attach the drive to metal or other noncombustible material.

# 1 Safety Instructions and General Warnings

## WARNING

- **Do not connect AC line power to output terminals U, V, and W.**
- **Make sure that the power supply lines are connected to main circuit input terminals R/L1, S/L2, T/L3 (or R/L1 and S/L2 for single-phase drives).**  
Do not connect the AC power line to the output motor terminals of the drive. Failure to comply could result in death or serious injury by fire as a result of drive damage from line voltage application to output terminals.

- **Tighten all terminal screws to the specified tightening torque.**  
Loose electrical connections could result in death or serious injury by fire due to overheating of electrical connections.

## CAUTION

### Crush Hazard

- **Do not carry the drive by the front cover.**  
Failure to comply may result in minor or moderate injury from the main body of the drive falling.

### Burn Hazard

- **Do not touch the heatsink or braking resistor hardware until a powered-down cooling period has elapsed.**

## NOTICE

### Equipment Hazard

- **Observe proper electrostatic discharge procedures (ESD) when handling the drive and circuit boards.**  
Failure to comply may result in ESD damage to the drive circuitry.
- **Never connect or disconnect the motor from the drive while the drive is outputting voltage.**  
Improper equipment sequencing could result in damage to the drive.
- **Do not perform a withstand voltage test on any part of the drive.**  
Failure to comply could result in damage to the sensitive devices within the drive.
- **Do not operate damaged equipment.**  
Failure to comply could result in further damage to the equipment.  
Do not connect or operate any equipment with visible damage or missing parts.



## NOTICE

- **Install adequate branch circuit short circuit protection per applicable codes.**  
Failure to comply could result in damage to the drive.  
The drive is suitable for circuits capable of delivering not more than 30,000 RMS symmetrical Amperes, 240 VAC maximum (200 V Class) and 480 VAC maximum (400 V Class).
- **Do not use unshielded cable for control wiring.**  
Failure to comply may cause electrical interference resulting in poor system performance. Use shielded twisted-pair wires and ground the shield to the ground terminal of the drive.
- **Do not allow unqualified personnel to use the product.**  
Failure to comply could result in damage to the drive or braking circuit.  
Carefully review the braking option instruction manual when connecting a braking option to the drive.
- **Do not modify the drive circuitry.**  
Failure to comply could result in damage to the drive and will void warranty.  
YASKAWA is not responsible for modification of the product made by the user. This product must not be modified.
- **Check all the wiring to ensure that all connections are correct after installing the drive and connecting other devices.**  
Failure to comply could result in damage to the drive.
- **Do not connect unapproved LC or RC interference suppression filters, capacitors, or overvoltage protection devices to the output of the drive.**  
Using unapproved filters could result in damage to the drive or motor equipment.

## ◆ Precautions for CE Low Voltage Directive Compliance

This drive has been tested according to European standard EN61800-5-1, and it fully complies with the Low Voltage Directive. The following conditions must be met to maintain compliance when combining this drive with other devices:

Do not use drives in areas with pollution higher than severity 2 and overvoltage category 3 in accordance with IEC664.

Ground the neutral point of the main power supply for 400 V Class drives.

## ◆ Precautions for UL/cUL Standards Compliance

This drive is tested in accordance with UL standard UL508C and complies with UL requirements. The following conditions must be met to maintain compliance when using this drive in combination with other equipment:

# 1 Safety Instructions and General Warnings

---

Do not install the drive to an area greater than pollution severity 2 (UL standard).

Use UL-listed copper wires (rated at 75°C) and closed-loop connectors or CSA-certified ring connectors. For details refer to the Technical Manual.

Wire low voltage wires with NEC Class 1 circuit conductors. Refer to national state or local codes for wiring. Use a class 2 (UL regulations) power supply for the control circuit terminal. For details refer to the Technical Manual.

This drive has undergone the UL short-circuit test, which certifies that during a short circuit in the power supply the current flow will not rise above 30,000 amps maximum at 240 V for 200 V class drives and 480 V for 400 V class drives.

The drive internal motor overload protection is UL listed and in accordance with the NEC and CEC. The setup can be done using the parameters L1-01/02. For details refer to the Technical Manual.

## ◆ **Precautions for Using the Safe Disable Function**

---

The drive's Safe Disable function is designed in accordance with the ISO13849-1 Cat.3, PL d and EN61508, SIL2. It can be utilized to perform a safe stop as defined by the EN60204-1, stop category 0 (uncontrolled stop by removal of power). Refer to the Technical Manual for details about the application of this function.

## 2 Mechanical Installation

### ◆ Upon Receipt

Please perform the following tasks after receiving the drive:

- Inspect the drive for damage. If the drive appears damaged upon receipt, contact your supplier.
- Verify receipt of the correct model by checking the information on the nameplate. If you have received the wrong model contact your supplier.

### ◆ Installation Environment

For optimum performance life of the drive, install the drive in an environment that meets the conditions listed below.

Environment	Conditions
Installation Area	Indoors
Ambient Temperature	-10 °C to +40 °C (NEMA Type 1) -10 °C to +50 °C (Open-Chassis Type) When using an enclosure panel, install a cooling fan or air conditioner in the area to ensure that the air temperature inside the enclosure does not exceed the specified levels. Do not allow ice to develop on the drive.
Humidity	95 % RH or less and free of condensation
Storage Temperature	-20 °C to +60 °C
Surrounding Area	Install the drive in an area free from: <ul style="list-style-type: none"> <li>• oil mist and dust</li> <li>• metal shavings, oil, water or other foreign materials</li> <li>• radioactive materials</li> <li>• combustible materials (e.g., wood)</li> <li>• harmful gases and liquids</li> <li>• excessive vibration</li> <li>• chlorides</li> <li>• direct sunlight</li> </ul>
Altitude	1000 m or less, up to 3000 m with derating (contact your sales representative or YASKAWA for more information)
Vibration	10 - 20 Hz at 9.8 m/s <sup>2</sup> , 20 - 55 Hz at 5.9 m/s <sup>2</sup>
Orientation	Install the drive vertically to maintain maximum cooling effects.

## 2 Mechanical Installation

### ◆ Installation Orientation and Spacing

Always install the drive in an upright position. Leave space around the unit for proper cooling as shown in the figure on the right.

**Note:** Several units can be installed closer together than shown in the figure by using “Side-by-Side” mounting. For details please refer to the Technical Manual.

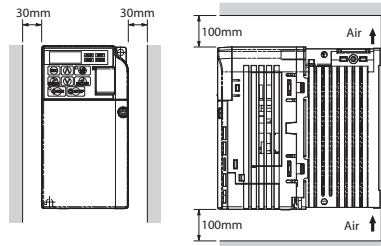

### ◆ Dimensions

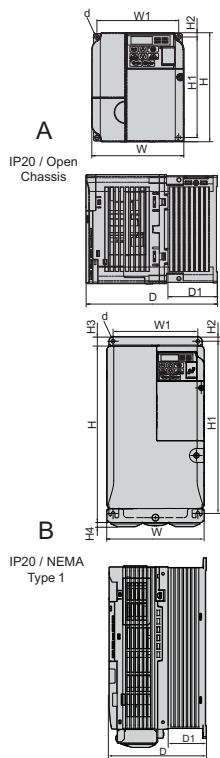

Model	Dimensions (mm)											Weight (kg)	
	Fig.	W	H	D	W1	H1	H2	H3	H4	D1	d		
CIMR-VC□													
BB0001B	A	68	128	76	56	118	5	-	-	6.5	M4	0.6	
BB0002B		68	128	76	56	118	5	-	-	6.5	M4	0.6	
BB0003B		68	128	118	56	118	5	-	-	38.5	M4	1.0	
BB0006B		108	128	137.5	96	118	5	-	-	58	M4	1.7	
BB0010B		108	128	154	96	118	5	-	-	58	M4	1.8	
BB0012B		140	128	163	128	118	5	-	-	65	M4	2.4	
BB0018B		170	128	180	158	118	5	-	-	65	M4	3.0	
2B0001B		68	128	76	56	118	5	-	-	6.5	M4	0.6	
2B0002B		68	128	76	56	118	5	-	-	6.5	M4	0.6	
2B0004B		68	128	108	56	118	5	-	-	38.5	M4	0.9	
2B0006B		68	128	128	56	118	5	-	-	38.5	M4	1.1	
2B0010B		108	128	129	96	118	5	-	-	58	M4	1.7	
2B0012B		108	128	137.5	96	118	5	-	-	58	M4	1.7	
2B0020B		140	128	143	128	118	5	-	-	65	M4	2.4	
2B0030F		140	254	140	122	248	6	13	6.2	55	M5	3.8	
2B0040F		140	254	140	122	248	6	13	6.2	55	M5	3.8	
2B0056F	180	290	163	160	284	8	15	6.2	75	M5	5.5		
2B0069B	220	350	187	192	336	7	15	7.2	78	M6	9.2		
4B0001B	108	128	81	96	118	5	-	-	10	M4	1.0		
4B0002B	108	128	99	96	118	5	-	-	28	M4	1.2		
4B0004B	108	128	137.5	96	118	5	-	-	58	M4	1.7		
4B0005B	108	128	154	96	118	5	-	-	58	M4	1.7		
4B0007B	108	128	154	96	118	5	-	-	58	M4	1.7		
4B0009B	108	128	154	96	118	5	-	-	58	M4	1.7		
4B0011B	140	128	143	128	118	5	-	-	65	M4	2.4		
4B0018F	140	254	140	122	248	6	13	6	55	M5	3.8		
4B0023F	140	254	140	122	248	6	13	6.2	55	M5	3.8		
4B0031F	180	290	143	160	284	8	15	6	55	M5	5.2		
4B0038F	180	290	163	160	284	8	15	6	75	M5	5.5		

## 2 Mechanical Installation

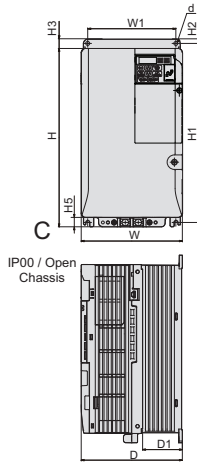

Model	Dimensions (mm)											Weight (kg)
	Fig.	W	H	D	W1	H1	H2	H3	H5	D1	d	
CIMR-VC□												
2B0030A	C	140	247	140	122	248	6	13	13	55	M5	3.6
2B0040A		140	247	140	122	248	6	13	13	55	M5	3.6
2B0056A		180	285	163	160	284	8	15	15	75	M5	5.3
2B0069A		220	335	187	192	336	7	15	15	78	M6	8.7
4B0018A		140	247	140	122	248	6	13	13	55	M5	3.6
4B0023A		140	247	140	122	248	6	13	13	55	M5	3.6
4B0031A		180	285	143	160	284	8	15	15	55	M5	5.0
4B0038A		180	285	163	160	284	8	15	15	75	M5	5.3

## 3 Electrical Installation

The figure below shows the main and control circuit wiring.

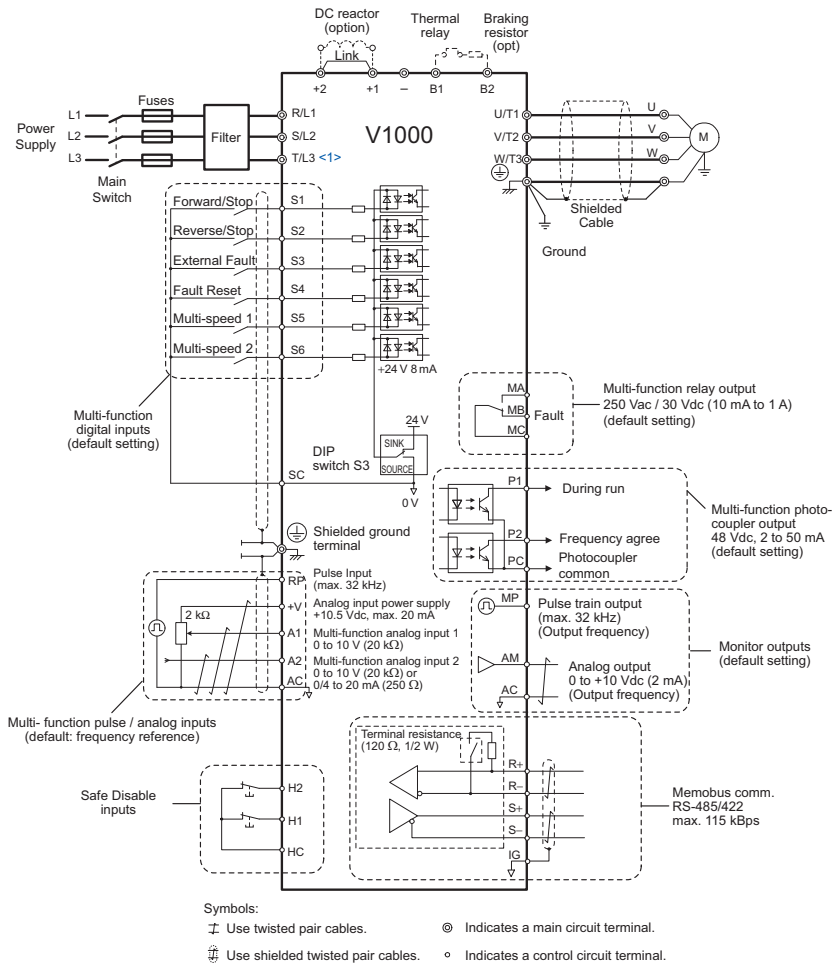

<1> Single-phase units do not have a T/L3 terminal.

## ◆ Wiring Specification

### ■ Main Circuit

Use the fuses and line filters listed up in the table below when wiring the main circuit. Make sure not to exceed the given tightening torque values.

Model CIMR-VC□	EMC Filter [Schaffner]	Main Fuse [Ferraz]	Recom. Motor cable (mm <sup>2</sup> )	Main Circuit Terminal Sizes		
				R/L1,S/L2,T/L3, U/ T1,V/T2,W/T3, -, +1, +2	B1, B2	⊕
BB0001	FS23638-10-07	TRS5R	2.5	M3.5	M3.5	M3.5
BB0002		TRS10R	2.5	M3.5	M3.5	M3.5
BB0003		TRS20R	2.5	M3.5	M3.5	M3.5
BB0006	FS23638-20-07	TRS35R	2.5	M4	M4	M4
BB0010		TRS50R	4	M4	M4	M4
BB0012	FS23638-30-07	TRS60R	6	M4	M4	M4
BB0018	FS23638-40-07	A6T80<1>	10	M5	M5	M5
2B0001	FS23637-08-07	TRS5R	2.5	M3.5	M3.5	M3.5
2B0002			2.5	M3.5	M3.5	M3.5
2B0004		TRS10R	2.5	M3.5	M3.5	M3.5
2B0006		TRS15R	2.5	M3.5	M3.5	M3.5
2B0010	FS23637-14-07	TRS25R	2.5	M4	M4	M4
2B0012		TRS35R	4	M4	M4	M4
2B0020	FS23637-24-07	TRS60R	6	M4	M4	M4
2B0030	FS23637-52-07	A6T70<1>	10	M4	M4	M5
2B0040		A6T100<1>	16	M4	M4	M5
2B0056	FS23637-68-07	A6T150<1>	25	M6	M5	M6
2B0069	FS23637-80-07	A6T200<1>	35	M8	M5	M6
4B0001	FS23639-5-07	TRS2.5R	2.5	M4	M4	M4
4B0002		TRS5R	2.5	M4	M4	M4
4B0004		TRS10R	2.5	M4	M4	M4
4B0005	FS23639-10-07	TRS20R	2.5	M4	M4	M4
4B0007			2.5	M4	M4	M4
4B0009			2.5	M4	M4	M4
4B0011	FS23639-15-07	TRS30R	2.5	M4	M4	M4
4B0018	FS23639-30-07	A6T50<1>	6	M4	M4	M5
4B0023		A6T60<1>	10	M4	M4	M5
4B0031	FS23639-50-07	A6T70<1>	10	M5	M5	M5
4B0038		A6T80<1>	16	M5	M5	M6

<1> For UL compliance a different fuse type has to be used. For details refer to Technical Manual.

### Tightening Torque Values

Tighten the main circuit terminals using the torque values provided by the table below.

Terminal Size	M3.5	M4	M5	M6	M8
Tightening Torque (N·m)	0.8 to 1.0	1.2 to 1.5	2.0 to 2.5	4.0 to 5.0	9.0 to 11.0

## 3 Electrical Installation

### ■ Control Circuit

The control terminal board is equipped with screwless terminals. Always use wires within the specification listed below. For safe wiring it is recommended to use solid wires or flexible wires with ferrules. The stripping length respectively ferrule length should be 8 mm.

Wire Type	Wire size (mm <sup>2</sup> )
Solid	0.2 to 1.5
Flexible	0.2 to 1.0
Flexible with ferrule	0.25 to 0.5

### ◆ EMC Filter Installation

This drive has been tested in accordance with European standards EN61800-3. In order to comply to the EMC standards, wire the main circuit as described below.

1. Install an appropriate EMC noise filter to the input side. See the list above or refer to the Technical Manual for details.
2. Place the drive and EMC noise filter in the same enclosure.
3. Use braided shield cable for the drive and motor wiring
4. Remove any paint or dirt from ground connections for minimal ground impedance
5. Install an AC reactor at drives smaller than 1 kW for compliance with the EN61000-3-2. Refer to the Technical Manual or contact your supplier for details

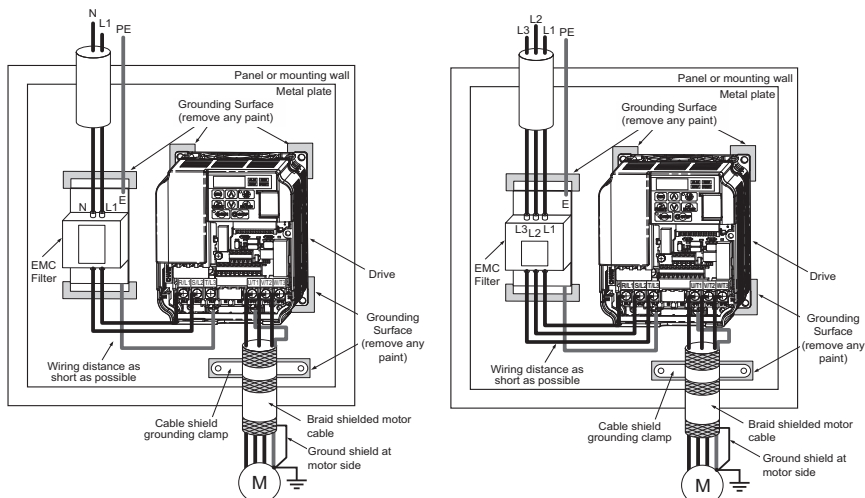

**EMC Standards Compliant Wiring of Single and Three Phase Units**



### ◆ Main and Control Circuit Wiring

#### ■ Wiring the Main Circuit Input

Consider the following precautions for the main circuit input.

- Use fuses recommended in Main Circuit on [page 15](#) only.
- If using a ground fault circuit breaker, make sure that it can detect both DC and high frequency current.
- If using an input switch is used, make sure that the switch does not operate not more than once every 30 minutes.
- Use a DC reactor or AC reactor on the input side of the drive:
  - To suppress harmonic current.
  - To improve the power factor on the power supply side.
  - When using an advancing capacitor switch.
  - With a large capacity power supply transistor (over 600 kVA).

#### ■ Wiring the Main Circuit Output

Consider the following precautions for the output circuit wiring.

- Do not connect any other load than a 3 phase motor to the drives output.
- Never connect a power source to the drives output.
- Never short or ground the output terminals.
- Do not use phase correction capacitors.
- If using a contactor between the drive and motor, it should never be operated when the drive is outputting a voltage. Operating while there is voltage output can cause large peak currents, thus tripping the over current detection or damage the drive.

#### ■ Ground Connection

Take the following precautions when grounding the drive.

- Never share the ground wire with other devices such as welding machines, etc.
- Always use a ground wire, that complies with electrical equipment technical standards. Keep ground wires as short as possible. Leakage current is caused by the drive. Therefore, if the distance between the ground electrode and the ground terminal is too long, potential on the ground terminal of the drive will become unstable.
- When using more than one drive, do not to loop the ground wire.

#### ■ Control Circuit Wiring Precautions

Consider the following precautions for wiring the control circuits.

- Separate control circuit wiring from main circuit wiring and other high-power lines.
- Separate wiring for control circuit terminals MA, MB, MC (contact output) from wiring to other control circuit terminals.

### 3 Electrical Installation

- For external control power supply use a UL Listed Class 2 power supply.
- Use twisted-pair or shielded twisted-pair cables for control circuits to prevent operating faults.
- Ground the cable shields with the maximum contact area of the shield and ground.
- Cable shields should be grounded on both cable ends.
- If flexible wires with ferrules are connected they might fit tightly into the terminals. To disconnect them, grasp the wire end with a pair of pliers, release the terminal using a straight-edge screw driver, turn the wire for about 45°, and pull it gently out of the terminal. For details, refer to the Technical Manual. Use this procedure for removing the wire link between HC, H1 and H2 when the Safe Disable function is utilized.

#### ■ Main Circuit Terminals

Terminal	Type	Function
R/L1, S/L2, T/L3	Main circuit power supply input	Connects line power to the drive. Drives with single-phase 200 V input power have no T/L3 terminal.
U/T1, V/T2, W/T3	Drive output	Connects to the motor.
B1, B2	Braking resistor	For connecting a braking resistor or the braking resistor unit option.
+1, +2	DC reactor connection	Linked at shipment. Remove the link to install a DC choke.
+1, -	DC power supply input	For connecting a DC power supply.
 (2 terminals)	Ground Terminal	-

#### ■ Control Circuit Terminals

The figure below shows the control circuit terminal arrangement. The drive is equipped with screwless terminals.

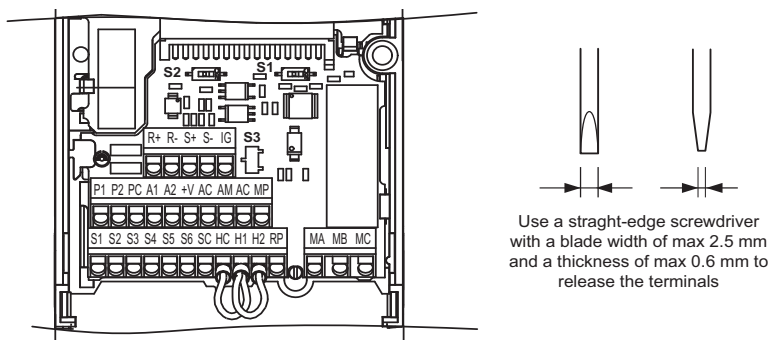

There are three DIP switches, S1 to S3, located on the terminal board

<b>SW1</b>	Switches analog input A2 between voltage and current input
<b>SW2</b>	Enables or disables the internal RS422/485 comm. port terminal resistance.
<b>SW3</b>	Used to select sourcing (PNP)/sinking (NPN, default) mode for the digital inputs (PNP requires external 24 VDC power supply)

#### ■ Control Circuit Terminal Functions

Type	No.	Terminal Name (Signal)	Function (Signal Level), Default Setting
Multi-Function Digital Inputs	S1 to S6	Multi-function digital input 1 to 6	Photocoupler inputs, 24 VDC, 8 mA Note: Drive preset to sinking mode (NPN). When using source mode, set DIP switch S3 to "SOURCE" and use an external 24 VDC ( $\pm 10\%$ ) power supply.
	SC	Multi-function input common	Sequence common
Multi-Function Analog/Pulse Inputs	RP	Pulse train input	Response frequency: 0.5 to 32 kHz, Duty: 30 to 70 %, High: 3.5 to 13.2 V, Low: 0.0 to 0.8 V, input impedance: 3 k $\Omega$ )
	+V	Analog input power supply	+10.5 V (max allowable current 20 mA)
	A1	Multi-function analog input 1	0 to +10 VDC (20 k $\Omega$ ) resolution 1/1000
	A2	Multi-function analog input 2	0/4 to 20 mA (250 $\Omega$ ) resolution: 1/500 (A2 only)
Safe Disable Inputs	AC	Frequency reference common	0 V
	HC	Safe Disable Input common	+24 V (max 10 mA allowed)
	H1	Safe Disable Input 1	One or both open: Drive output disabled (time from input open to drive output switch off is less than 1 ms) Both Closed: Normal operation
H2	Safe Disable Input 2		
Multi-Function Relay Output	MA	N.O. (fault)	Digital relay output 30 VDC, 10 mA to 1 A 250 VAC, 10 mA to 1 A
	MB	N.C. output (fault)	
	MC	Digital output common	
Multi-Function PHC Output	P1	Photocoupler output 1	Digital photocoupler output 48 VDC, 2 to 50 mA
	P2	Photocoupler output 2	
	PC	Photocoupler output common	
Monitor Output	MP	Pulse train output	32 kHz (max)
	AM	Analog monitor output	0 to 10 VDC (2 mA or less), Resolution: 1/1000 (10 bit)
	AC	Monitor common	0 V
MEMO-BUS/Communication	R+	Communications input (+)	MEMOBUS/Modbus communication.: RS-485 or RS-422, 115.2 kbps (max)
	R-	Communications input (-)	
	S+	Communications output (+)	
	S-	Communications output (-)	

**NOTICE!** The terminals HC, H1, H2 are used for the Safe Disable function which cuts the output voltage in less than 1 ms if at least one of the inputs H1 or H2 is opened. It is designed in accordance with the EN954-1/ISO13849-1, safety category 3 and EN61508, SIL2. It and can be utilized to perform a safe stop as defined by the EN60204-1, stop category 0. Do not remove the wire link between HC, H1, or H2 unless the Safe Disable function is used. Refer to the Technical Manual when using this function.

**NOTICE!** The wiring length to the terminals HC, H1 and H2 should not exceed 30 m.

# 4 Keypad Operation

## ◆ LED Operator and Keys

The LED operator is used to program the drive, to start/stop it, and to display fault information. The LEDs indicate the drive status.



## ■ Keys and Functions

Display	Name	Function
	Data Display Area	Displays the frequency reference, parameter number, etc.
	ESC Key	Returns to the previous menu.
	RESET Key	Moves the cursor to the right. Resets a fault.
	RUN Key	Starts the drive in the LOCAL mode. The Run LED <ul style="list-style-type: none"> <li>• is on, when the drive is operating the motor.</li> <li>• flashes during deceleration to stop or when the frequency reference is 0.</li> <li>• flashes quickly the drive is disabled by a DI, the drive was stopped using a fast stop DI or a run command was active during power up.</li> </ul>
	Up Arrow Key	Scrolls up to select parameter numbers, setting values, etc.
	Down Arrow Key	Scrolls down to select parameter numbers, setting values, etc.
	STOP Key	Stops the drive.
	ENTER Key	Selects modes, parameters and is used to store settings.
	LO/RE Selection Key	Switches drive control between the operator (LOCAL) and the control circuit terminals (REMOTE). The LED is on when the drive is in the LOCAL mode (operation from keypad).
	ALM LED Light	Flashing: The drive is in an alarm state. On: The drive is in a fault state and the output is stopped.
	REV LED Light	On: The motor rotation direction is reverse. Off: The motor rotation direction is forward.
	DRV LED Light	On: The drive is ready to operate the motor. Off: The drive is in the Verify, Setup or Parameter Setting.
	FOUT LED Light	On: The output frequency is displayed on the data screen. Off: Anything else than the output frequency is displayed on the data screen.

## ◆ Menu Structure and Modes

The following illustration explains the operator keypad menu structure.

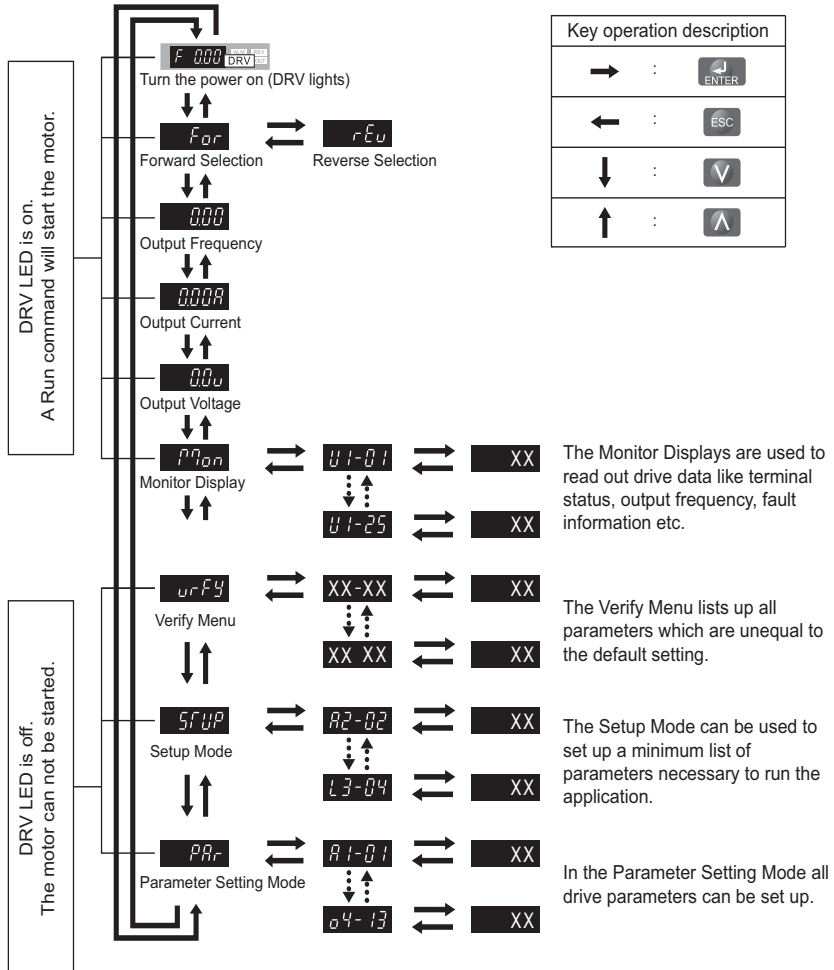

# 5 Modification from Standard Software

### ◆ Overview

Changed Item	High Frequency Software	Standard Software
Maximum Output Frequency	1000 Hz	400 Hz
Carrier Frequency	Max: 7 kHz C6-02: 2, B, C, F	Max: 15 kHz C6-02: 1 ~ A, F
Drive Current Rating	Fixed at Heavy Duty (HD) ratings	Depends on C6-01
Drive Overload Rating	Fixed at 150 %/1 min	Depends on C6-01
Control Mode	Fixed at V/f	V/f, OLV, OLV for PM
Frequency Setting Resolution	Fixed at 0.1 Hz	0.01 Hz (less than 100 Hz) 0.1 Hz (above 10 Hz)
Frequency reference and output frequency display units. <1><2>	o1-03 parameter (same as b5-20) 0: 0.1 Hz 1: 0.01 (Max frequency 100 %) 2: Deleted 3: User Defined (o1-10 and o1-11)	o1-03 parameter (same as b5-20) 0: 0.1 Hz 1: 0.01 (Max frequency 100 %) 2: RPM 3: User Defined (o1-10 and o1-11)
Torque Compensation	Enabled only at low speeds.	Enabled throughout the entire frequency range.
On-Delay Compensation	Enabled only at low speeds. Addition of On-Delay Compensation Selection parameter S1-01	Enabled throughout the entire frequency range.
Stall Prevention Level During Acceleration (L3-02)	Maximum setting: 170 %	Maximum setting: 150 %
Deleted Functions	All OLV and OLV for PM specific monitors Estimation type Speed Search High Slip Braking (HSB) Auto-Tuning KEB Overexcitation Deceleration V/f with simple PG Feedback	-

<1> MEMOBUS/Modbus frequency reference setting resolution 13bit, 0.1 Hz. E.g. for 1000 Hz reference, 10000 (2710Hex) must be set to MEMOBUS/Modbus register 0002Hex.

<2> Also applies to register data via MEMOBUS/Modbus communication.

### ◆ Modified Parameters

#### ■ Deleted Parameters/Functions from Standard Software

Parameter	Name
A1-02	Control Method
A1-06	Application Preset
b2-08	Magnetic Flux Compensation Value
b2-12, b2-13	Short Circuit Brake Parameters
b3-06	Output Current 1 during Speed Search (Estimation Type)
b3-10	Speed Search Detection Compensation Gain (Estimation Type)
b3-24	Speed Search Method Selection
b8-xx	Energy Saving Control Parameters
C3-05	Output Voltage Limit Selection
C4-03 ~ C3-06	Torque Compensation Parameters
C5-xx	Automatic Speed Regulation (ASR)
C6-01	Normal/Heavy Duty Selection
d4-11	Bi-Directional Output Selection
d4-12	Stop Position Gain
E2-07, E2-08, E2-12	Motor Iron-Core Saturation Coefficients
E2-09	Motor Mechanical Loss
E3-01	Motor 2 Control Method Selection
F1-xx	V/f with simple PG Feedback
E4-07, E4-08, E4-12	Motor 2 Iron-Core Saturation Coefficients
E4-09	Motor 2 Mechanical Loss
L2-06 ~ L2-11	KEB Parameters
L3-11, L3-22	ov Suppression Function Selection
L7-xx	Torque Limit
L8-29	Current Unbalance Detection (LF2)
n2-xx	Automatic Frequency Regulation (AFR)
n3-xx	High Slip Braking/Overexcitation Deceleration Parameters
n6-xx	Online Tuning
n8-xx	PM Motor Control Tuning
T1-01 ~ T1-08	Motor Tuning Parameters

## 5 Modification from Standard Software

### Deleted Multi-function Digital Inputs (H1 Group)

Setting	Function
65, 66	KEB Ride-thru 1
68	HSB (High Slip Braking)
7A, 7B	KEB Ride-thru 2
7C, 7D	Short Circuit Braking
7E	Forward/Reverse Detection (V/f with simple PG)

### Deleted Multi-function Digital Outputs (H2 Group)

Setting	Function
30	During Torque Limit
4A	During KEB Operation
4B	During Short Circuit Brake

### Modified Parameter Setting Ranges

Parameter	Name	Setting Range
b4-01	Timer Function On-Delay Time	0.0 to 3000.0 s
b4-02	Timer Function Off-Delay Time	0.0 to 3000.0 s
b5-20	PID Setpoint Scaling	0, 1, 3
H6-01	Pulse Train Input Terminal RP Function Selection	0, 1, 2
L3-02	Stall Prevention Level during Acceleration	0 to 170 %
L3-04	Stall Prevention Selection during Deceleration	0 to 3
o1-03	Digital Operator Display Selection	0, 1, 3

### Parameters with Modified Defaults

Parameter	Name	Setting Range	Default	Previous Default
b2-04	DC Injection Braking Time at Stop	0.0 ~ 10.0	0.0 s	0.5
n1-01	Hunting Prevention Selection	0, 1	0 (off)	1 (on)



## 5 Modification from Standard Software

### ■ New Parameter

Parameter	Name	Setting Range	Default	Note
S1-01	On-Delay Compensation Selection	0, 1	1	0: Disabled, 1: Enabled

### ■ Parameters with Modified Upper Limits

Parameter	Name	Setting Range	Default
b5-19	PID Setpoint Value	0.0 to 1000.0	0.0 Hz
C1-11	Accel/Decel Time Switching Frequency	0.0 to 1000.0	0.0 Hz
d1-01	Frequency Reference 1	0.0 to 1000.0	0.0 Hz
d1-02	Frequency Reference 2	0.0 to 1000.0	0.0 Hz
d1-03	Frequency Reference 3	0.0 to 1000.0	0.0 Hz
d1-04	Frequency Reference 4	0.0 to 1000.0	0.0 Hz
d1-05	Frequency Reference 5	0.0 to 1000.0	0.0 Hz
d1-06	Frequency Reference 6	0.0 to 1000.0	0.0 Hz
d1-07	Frequency Reference 7	0.0 to 1000.0	0.0 Hz
d1-08	Frequency Reference 8	0.0 to 1000.0	0.0 Hz
d1-09	Frequency Reference 9	0.0 to 1000.0	0.0 Hz
d1-10	Frequency Reference 10	0.0 to 1000.0	0.0 Hz
d1-11	Frequency Reference 11	0.0 to 1000.0	0.0 Hz
d1-12	Frequency Reference 12	0.0 to 1000.0	0.0 Hz
d1-13	Frequency Reference 13	0.0 to 1000.0	0.0 Hz
d1-14	Frequency Reference 14	0.0 to 1000.0	0.0 Hz
d1-15	Frequency Reference 15	0.0 to 1000.0	0.0 Hz
d1-16	Frequency Reference 16	0.0 to 1000.0	0.0 Hz
d1-17	Jog Frequency Reference	0.0 to 1000.0	0.0 Hz
d3-01	Jump Frequency 1	0.0 to 1000.0	0.0 Hz
d3-02	Jump Frequency 2	0.0 to 1000.0	0.0 Hz
d3-03	Jump Frequency 3	0.0 to 1000.0	0.0 Hz
E1-04	Maximum Output Frequency	0.0 to 1000.0	50.0 Hz
E1-06	Base Frequency	0.0 to 1000.0	50.0 Hz
E1-07	Mid Output Frequency	0.0 to 1000.0	2.5 Hz
E1-09	Minimum Output Frequency	0.0 to 1000.0	1.3 Hz

## 5 Modification from Standard Software

Parameter	Name	Setting Range	Default
E1-11	Mid Output Frequency 2	0.0 to 1000.0	0.0 Hz
E3-04	Motor 2 Maximum Output Frequency	0.0 to 1000.0	50.0 Hz
E3-06	Motor 2 Base Frequency	0.0 to 1000.0	50.0 Hz
E3-07	Motor 2 Mid Output Frequency	0.0 to 1000.0	2.5 Hz
E3-09	Motor 2 Minimum Output Frequency	0.0 to 1000.0	1.3 Hz
E3-11	Motor 2 Mid Output Frequency 2	0.0 to 1000.0	0.0 Hz
L4-01	Speed Agreement Detection Level	0.0 to 1000.0	0.0 Hz
L4-03	Speed Agreement Detection Level (+/-)	-999.9 to 999.9	0.0 Hz

### ■ Modified Monitors

Parameter	Name	Setting Range
U1-01	Frequency Reference	0.0 to 1000.0 Hz
U1-02	Output Frequency	0.0 to 1000.0 Hz
U1-16	Output Frequency after Soft Start	0.0 to 1000.0 Hz
U2-03	Frequency Reference at Previous Fault	0.0 to 1000.0 Hz
U2-04	Output Frequency at Previous Fault	0.0 to 1000.0 Hz
U4-14	Peak Hold Output Frequency	0.0 to 1000.0 Hz

### ■ Deleted Monitors

Parameter	Name
U1-05	Motor Speed
U1-09	Torque Reference
U2-06	Motor Speed at previous Fault
U2-10	Torque Reference at previous Fault
U2-17	Motor Id Current at previous Fault
U6-02 to U6-08	ASR, ACR and PM Motor Control Monitors

### ■ Modified MEMOBUS/Modbus Communication Data

Register	Name	Data
2H	Frequency Reference	Setting upper limit 40000 to FFFFH
3EH	Output Frequency RPM	Deleted

### ◆ New and modified Software Functions

#### ■ Carrier Frequency

- The carrier frequency upper limit changed from 15.0kHz to 7.0kHz and two new patterns were added.
- The carrier frequency selection parameter (C6-02) has been modified according to the table below.

C6-02 Carrier Frequency Selection	C6-03 Carrier Frequency Upper Limit	C6-04 Carrier Frequency Lower Limit	C6-05 Carrier Frequency Proportional Gain	Note
2	5.0	5.0	0	Same as Standard
B	7.0	1.0	12	New Setting
C	7.0	1.0	8	New Setting
F	2.0	2.0	0	Same as Standard

#### ■ Torque Compensation

High speed motors typically have very low impedance compared to standard 60/120 Hz motors. These high speed/low impedance motors saturate easily and may cause hunting and oscillation when a high V/f pattern is applied, especially at high frequencies. Therefore, Torque Compensation Gain (C4-01) is modified to limit voltage boost above 120 Hz and eliminate voltage boost above 160 Hz as shown following diagram.



#### ■ On-Delay Compensation

High speed motors typically operate at low V/f ratios compared to standard 60/120 Hz motors, and On-Delay Compensation settings may adversely affect the motor voltage and cause hunting and oscillation. Therefore, On-Delay Compensation Gain is modified to reduce its effectiveness above 120 Hz as shown in following diagram.

## 5 Modification from Standard Software

---

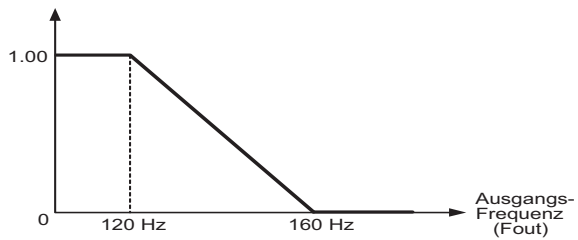

The parameter S1-01 is added to enable/disable On-Delay Compensation manually.

## 6 Start Up

### ◆ Drive Setup Procedure

The illustration below shows the basic setup procedure. Each step is explained more detailed on the following pages.

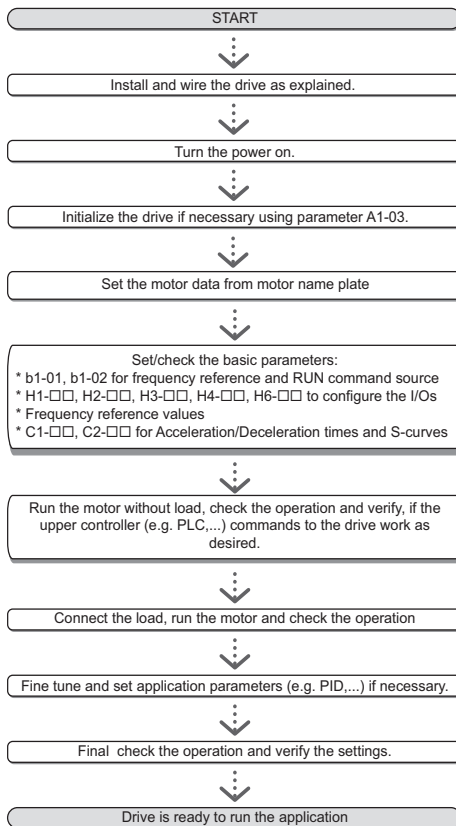

## 6 Start Up

---

### ◆ Power On

Before turning on the power supply,

- Make sure all wires are connected properly.
- Make sure no screws, loose wire ends or tools are left in the drive.
- After turning the power on, the drive mode display should appear and no fault or alarm should be displayed.

### ◆ Frequency Reference and Acceleration/ Deceleration Times

---

#### ■ Frequency Reference Source (b1-01)

Set parameter b1-01 according to the frequency reference used.

b1-01	Reference source	Frequency reference input
0	Operator keypad	Set the frequency references in the d1-□□ parameters and used digital inputs to switch over between different reference values.
1	Analog input	Apply the frequency reference signal to terminal A1 or A2.
2	Serial Comm.	Serial Communications using the RS422/485 port
3	Option Board	Communications option card
4	Pulse input	Set the frequency reference at terminal RP using a pulse train signal.

#### ■ Run Command Source (b1-02)

Set parameter b1-02 according to the frequency reference used.

b1-02	RUN command source	Frequency reference input
0	Operator keypad	RUN and STOP keys on the operator
1	Multi-Function digital input	Multi-Function digital input
2	Serial Comm.	Serial Communications using the RS422/485 port
3	Option Board	Communications option card

#### ■ Acceleration/ Deceleration Times and S-Curves

There are four sets of acceleration and deceleration times which can be set in the C1-□□ parameters. The default activated accel/decel times are C1-01/02. Adjust these times to the appropriate values required by the application. If necessary S-curves can be activated in the C2-□□ parameters for softer accel/decel start and end.

## ◆ Reference and Run Source

The drive has a LOCAL and a REMOTE mode.

Status	Description
LOCAL	The Run/ Stop command and the frequency reference are entered at the operator keypad.
REMOTE	The Run command source entered in parameter b1-02 and the frequency reference source entered in parameter b1-01 are used.

If the drive is operated in the REMOTE mode, make sure that the correct sources for the frequency reference and run command are set in parameters b1-01/02 and that the drive is in the REMOTE mode.

The LED in the LO/RE key indicates where the Run command is input from.

LO/RE LED	Description
ON	Run command is issued from operator.
OFF	Run command is issued from a different source than the operator.

## ◆ I/O Setup

### ■ Multi-Function Digital Inputs (H1-□□)

The function of each digital input can be assigned in the H1-□□ parameters. The default setting functions can be seen in the connection diagram on [page 14](#).

### ■ Multi-Function Digital Outputs (H2-□□)

The function of each digital output can be assigned in the H2-□□ parameters. The default setting functions can be seen in the connection diagram on [page 14](#). The setting value of these parameters consist of 3 digits, where the middle and right digit set the function and the left digit sets the output characteristics (0: Output as selected; 1: Inverse output).

### ■ Multi-Function Analog Inputs (H3-□□)

The function of each analog input can be assigned in the H3-□□ parameters. The default setting of both inputs is “Frequency bias”. Input A1 is set for 0 to 10V input and A2 is set for 4-20 mA input. The addition of both input values builds the frequency reference.

**NOTICE!** *If the input signal level of input A2 is switched between voltage and current, make sure that DIP switch S1 is in the correct position and parameter H3-09 is set up correctly.*

### ■ Monitor Output (H4-□□)

Use the H4-□□ parameters to set up the output value of the analog monitor output and to adjust the output voltage levels. The default monitor value setting is “Output frequency”.

### ◆ Frequency Reference and Acceleration/ Deceleration Times

---

#### ■ Frequency Reference Setup (b1-01)

Set parameter b1-01 according to the frequency reference used.

b1-01	Reference source	Frequency reference input
0	Operator keypad	Set the frequency references in the d1-□□ parameters and used digital inputs to switch over between different reference values.
1	Analog input	Apply the frequency reference signal to terminal A1 or A2.
2	Serial Comm.	Serial Communications using the RS422/485 port
3	Option Board	Communications option card
4	Pulse input	Set the frequency reference at terminal RP using a pulse train signal.

#### ■ Acceleration/ Deceleration Times and S-Curves

There are four sets of acceleration and deceleration times which can be set in the C1-□□ parameters. The default activated accel/decel times are C1-01/02. Adjust these times to the appropriate values required by the application. If necessary S-curves can be activated in the C2-□□ parameters for softer accel/decel start and end.

### ◆ Test Run

---

Perform the following steps to start up the machine after all parameter settings have been done.

1. Run the motor without load and check if all input, outputs and the sequence work as desired.
2. Connect the load to the motor.
3. Run the motor with load and make sure that there is no vibrations, hunting or motor stalling occurs.

After taking the steps listed above, the drive should be ready to run the application and perform the basic functions. For special setups like PID control etc. refer to the Technical Manual.



## 7 Parameter Table

This parameter table shows the most important parameters. Default settings are bold type. Refer to the Technical Manual for a complete list of parameters.

Par.	Name	Description
<b>Initialization Parameters</b>		
A1-01	Access Level Selection	Selects which parameters are accessible via the digital operator. 0: Operation only 1: User Parameters 2: <b>Advanced Access Level</b>
A1-03	Initialize Parameters	Resets all parameters to default. (returns to 0 after initialization) 0: No Initialize 1110: User Initialize (The user must first set user parameter values and then store them using parameter o2-03) 2220: 2-Wire Initialization 3330: 3-Wire Initialization
<b>Operation Mode Selection</b>		
b1-01	Frequency Reference Selection	0: Operator - d1-□□ values 1: <b>Analog input A1 or A2</b> 2: Serial Com - RS-422/485 3: Option board 4: Pulse Input (Terminal RP)
b1-02	Run Command Selection	0: Operator - RUN and STOP keys 1: <b>Terminals - Digital Inputs</b> 2: Serial Com - RS-422/485 3: Option board connected
b1-03	Stopping Method Selection	Selects the stopping method when the run command is removed. 0: <b>Ramp to Stop</b> 1: Coast to Stop 2: DC Injection Braking to Stop 3: Coast with Timer (a new run command is ignored if received before the timer expires)
b1-04	Reverse Operation Selection	0: <b>Reverse enabled</b> 1: Reverse prohibited

Par.	Name	Description
b1-14	Phase Order Selection	Switches the output phase order. 0: <b>Standard</b> 1: Switch phase order
<b>DC Injection Braking</b>		
b2-01	DC Injection Braking Start Frequency	Sets the frequency at which DC Injection Braking starts when Ramp to Stop (b1-03 = 0) is selected. If b2-01 < E1-09, DC Injection Braking starts at E1-09.
b2-02	DC Injection Braking Current	Sets the DC Injection Braking current as a percentage of the drive rated current. In OLV the DC excitation current is determined by E2-03.
b2-03	DC Inj. Braking Time/DC Excitation Time at Start	Sets the time of DC Injection Braking at start in units of 0.01 seconds. Disabled when set to 0.00 seconds.
b2-04	DC Inj. Braking Time at Stop	Sets the DC Injection Braking time at stop. Disabled when set to 0.00 seconds.
<b>Acceleration/ Deceleration</b>		
C1-01	Accel Time 1	Sets the acceleration time 1 from 0 to the max. output frequency.
C1-02	Decel Time 1	Sets the deceleration time 1 from the max. output frequency to 0.
Par.	Name	Description
C1-03 to C1-08	Accel/Decel Times 2 to 4	Set the accel/decel times 2 to 4 (set like C1-01/02).
C2-01	S-Curve 1	S-curve at acceleration start.
C2-02	S-Curve 2	S-curve at acceleration end.
C2-03	S-Curve 3	S-curve at deceleration start.
C2-04	S-Curve 4	S-curve at deceleration end.

## 7 Parameter Table

Par.	Name	Description
<b>Slip Compensation</b>		
C3-01	Slip Compensation Gain	<ul style="list-style-type: none"> <li>• Increase if the speed is lower than the frequency reference.</li> <li>• Decrease if the speed is higher than the frequency reference.</li> </ul>
C3-02	Slip Compensation Delay Time	<ul style="list-style-type: none"> <li>• Decrease the setting when the slip compensation is too slow.</li> <li>• Increase the setting when the speed is not stable.</li> </ul>
<b>Torque Compensation</b>		
C4-01	Torque Compensation Gain	<ul style="list-style-type: none"> <li>• Increase this setting when the torque response is slow.</li> <li>• Decrease this setting when speed/torque oscillations occur.</li> </ul>
C4-02	Torque Compensation Delay Time	<ul style="list-style-type: none"> <li>• Increase this setting when speed / torque oscillations occur.</li> <li>• Decrease the setting when the torque response is too slow.</li> </ul>
<b>Duty Mode and Carrier Frequency</b>		
C6-02	Carrier Frequency Selection	2: 5kHz B, C: See supplement manual F: User Defined
<b>Frequency References</b>		
d1-01 to d1-16	Frequency Reference 1 to 16	Set the multi-speed references 1 to 16.
d1-17	Jog Speed	Jog speed
<b>V/f Pattern</b>		
E1-01	Input Voltage Setting	Input Voltage

Par.	Name	Description
E1-04	Max. Output Freq.	For a linear V/f characteristics, set the same values for E1-07 and E1-09. In this case, the setting for E1-08 will be disregarded. Ensure that the four frequencies are set according to these rules or OPE10 fault will occur:  $E1-04 \geq E1-06 \geq E1-07 \geq E1-09$
E1-05	Max. Output Voltage	
E1-06	Base Frequency	
E1-07	Middle Output Freq.	
E1-08	Mid. Output Voltage	
E1-09	Min. Output Freq.	
E1-10	Min. Output Voltage	
E1-13	Base Voltage	
<b>Motor Data</b>		
E2-01	Motor Rated Current	From Motor nameplate.<1>
E2-02	Motor Rated Slip	Motor rated slip in hertz (Hz).<1> calculate: $n_{\text{sync}} - n_{\text{nom}} / n_{\text{sync}} * f_{\text{nom}}$
E2-03	Motor No-Load Current	Magnetizing current in Amperes.<1>
E2-04	Motor Poles	Number of motor poles.<1>
E2-05	Motor Line-to-Line Resistance	Sets the phase-to-phase motor resistance in ohms.<1>
E2-06	Motor Leakage Inductance	Sets the voltage drop due to motor leakage inductance as a percentage of motor rated voltage.<1>
<b>Digital Input Settings</b>		
H1-01 to H1-06	DI S1 to S6 Function Selection	Selects the function of terminals S1 to S6.
Major functions are listed at the end of the table.		
<b>Digital Output Settings</b>		
H2-01	DO MA/MB Function	Set the function for the relay output MA-MB-MC.

## 7 Parameter Table

Par.	Name	Description
H2-02	DO P1 Function	Sets the function for the photocoupler output P1.
H2-03	DO P2 Function	Sets the function for the photocoupler output P2.
Major functions are listed at the end of the table.		
<b>Analog Input Setting</b>		
H3-01	A1 Signal Level Sel.	<b>0:0 to +10 V (neg. input is zeroed)</b> 1:0 to +10 V (bipolar input)
H3-02	A1 Function Sel.	Assign a function to terminal A1.
H3-03	A1 Gain	Sets the input value in % at 10 V analog input.
H3-04	A1 Bias	Sets the input value in % at 0 V analog input.
H3-09	A2 Signal Level Selection	0:0 to +10 V (neg. input is zeroed) 1:0 to +10 V (bipolar input) <b>2:4 to 20 mA (9 bit input)</b> 3:0 to 20 mA
H3-10	A2 Function Sel.	Assign a function to terminal A2.
H3-11	A2 Gain	Sets the input value in % at 10 V/20 mA analog input.
H3-12	A2 Bias	Sets the input value in % at 0 V/0 mA/4 mA analog input.
<b>Analog Input Setting</b>		
H4-01	AM Monitor Selection	Enter value equal to U1-□□ monitor values. Example: Enter "103" for U1-03.
H4-02	AM Gain	Sets terminal AM output voltage equal to 100 % monitor value.
H4-02	AM Bias	Sets terminal AM output voltage equal to 0 % monitor value.
<b>Pulse Input Setting (Frequ. ref. input)</b>		
H6-02	RP Input Scaling	Sets the number of pulses (in Hz) that is equal to 100 % input value.
H6-03	Pulse Train Input Gain	Sets the input value in % at pulse input with H6-02 frequency.
H6-04	Pulse Train Input Bias	Sets the input value in % at 0 Hz pulse input frequency.

Par.	Name	Description
<b>Pulse Output Setting</b>		
H6-06	MP Monitor Sel.	Enter value equal to U□-□□ monitor values. Example: Enter "102" for U1-02.
H6-07	MP Monitor Scaling	Sets the number of output pulses when the monitor is 100 % (in Hz).
<b>Motor Overheat Protection</b>		
L1-01	Motor Overload Prot. Sel.	Sets the motor overload protection. 0:Disabled <b>1:Standard fan cooled motor</b> 2:Standard blower cooled motor 3:Vector motor
L1-02	Motor Overload Prot. Time	Sets the motor overload protection time in min. Normally no change is necessary.
<b>Stall Prevention</b>		
L3-01	Stall Prevention Selection during Acceleration	0:Disabled - Motor accelerates at active acceleration rate and may stall with too heavy load or too short accel time. <b>1:General Purpose - Hold acceleration when current is above L3-02.</b> 2:Intelligent - Acceleration in the shortest possible time.
L3-02	Stall Prev. Level during Accel.	Sets the current level for stall prevention during acceleration.
L3-04	Stall Prev. Selection during Decel.	0:Disabled - Deceleration as set. OV might occur. <b>1:General Purpose - Deceleration is hold if DC bus voltage rises high.</b>
L3-05	Stall Prev. Selection during Run	0:Disabled - Motor stall or overload might occur. <b>1:Decel Time 1 - Reduce speed using C1-02.</b>
L3-06	Stall Prev. Level during Run	Sets the current level at which stall prevention during run starts to operate.

<1> Data should be provided by motor manufacturer.

## 7 Parameter Table

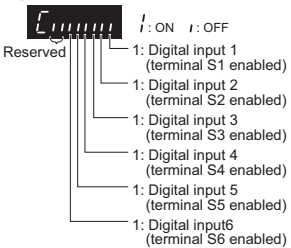
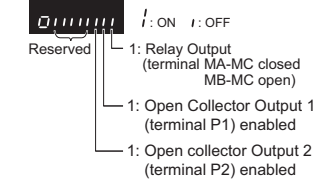
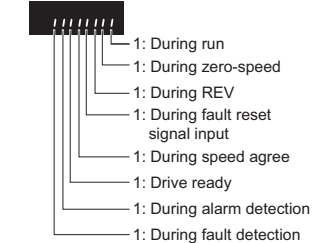
Monitor	Description
U1-01	Frequency Reference (Hz)
U1-02	Output Frequency (Hz)
U1-03	Output Current (A)
U1-06	Output Voltage Reference (VAC)
U1-07	DC Bus Voltage (VDC)
U1-08	Output Power (kW)
U1-10	<b>Input Terminal Status</b>  <p>Reserved</p> <ul style="list-style-type: none"> <li>1: Digital input 1 (terminal S1 enabled)</li> <li>1: Digital input 2 (terminal S2 enabled)</li> <li>1: Digital input 3 (terminal S3 enabled)</li> <li>1: Digital input 4 (terminal S4 enabled)</li> <li>1: Digital input 5 (terminal S5 enabled)</li> <li>1: Digital input 6 (terminal S6 enabled)</li> </ul>
	<b>Output Terminal Status</b>  <p>Reserved</p> <ul style="list-style-type: none"> <li>1: Relay Output (terminal MA-MC closed MB-MC open)</li> <li>1: Open Collector Output 1 (terminal P1) enabled</li> <li>1: Open collector Output 2 (terminal P2) enabled</li> </ul>
U1-11	
U1-12	<b>Drive Status</b>  <ul style="list-style-type: none"> <li>1: During run</li> <li>1: During zero-speed</li> <li>1: During REV</li> <li>1: During fault reset signal input</li> <li>1: During speed agree</li> <li>1: Drive ready</li> <li>1: During alarm detection</li> <li>1: During fault detection</li> </ul>

Monitor	Description
U1-13	Terminal A1 input level
U1-14	Terminal A2 input level
U1-16	Soft Starter Output (freq after accel/decel ramps)
U1-18	OPE Fault Parameter
U1-24	Pulse Input frequency
<b>Fault Trace</b>	
U2-01	Current Fault
U2-02	Previous Fault
U2-03	Frequency Reference at Previous Fault
U2-04	Output Frequency at Previous Fault
U2-05	Output Current at Previous Fault
U2-06	Motor Speed at Previous Fault
U2-07	Output Voltage at Previous Fault
U2-08	DC Bus Voltage at Previous Fault
U2-09	Output Power at Previous Fault
U2-10	Torque Reference at Previous Fault
U2-11	Input Terminal Status at Previous Fault
U2-12	Output Terminal Status at Previous Fault
U2-13	Drive Operation Status at Previous Fault
U2-14	Cumulative Operation Time at Previous Fault
U2-15	Soft-Starter Speed Reference at Previous Fault
U2-16	Motor q-Axis Current at Previous Fault
<b>Fault History</b>	
U3-01 to U3-04	Lists the most recent fault that occurred through the fourth most recent fault.
U3-05 to U3-08	Accumulated operation time at the most recent fault through the fourth most recent fault.
U3-09 to U3-14	Lists the fifth most recent fault that occurred through the tenth most recent fault.
U3-15 to U3-20	Accumulated operation time at fifth most recent fault through the tenth most recent fault.
* The following faults are not recorded in the error log: CPF00, 01, 02, 03, UV1, and UV2.	

DI/DO Sel.	Description
<b>Digital Input Function Selections</b>	
3	Multi-step speed reference 1
4	Multi-step speed reference 2
5	Multi-step speed reference 3
6	Jog frequency command (higher priority than multi-step speed reference)
7	Accel/decel time selection 1
F	Not used (Set when a terminal is not used)
14	Fault reset (Reset when turned ON)
20 to 2F	External fault; Input mode: N.O. contact / N.C. contact, Detection mode: Normal/during operation
<b>Digital Output Function Selections</b>	
0	During Run (ON: run command is ON or voltage is being output)
1	Zero Speed
2	Speed Agree
6	Drive Ready
E	Fault
F	Not used
10	Minor fault (Alarm) (ON: Alarm displayed)

# 8 Troubleshooting

### ◆ General Fault and Alarms

Faults and alarms indicate problems in the drive or in the machine.

An alarm is indicated by a code on the data display and the flashing ALM LED. The drive output is not necessarily switched off.

A fault is indicated by a code on the data display and the ALM LED is on. The drive output is always switched off immediately and the motor coast to stop.

To remove an alarm or reset a fault, trace the cause, remove it and reset the drive by pushing the Reset key on the operator or cycling the power supply.

This lists up the most important alarms and faults only. Please refer to the Technical Manual for a complete list.

LED Display	AL	FLT	Cause	Corrective Action
Base Block bb	○		The software base block function is assigned to one of the digital inputs and the input is off. The drive does not accept Run commands.	<ul style="list-style-type: none"> <li>• Check the digital inputs function selection.</li> <li>• Check the upper controller sequence.</li> </ul>
Control Fault CF		○	The torque limit was reached during deceleration for longer than 3 sec. when in Open Loop Vector control. <ul style="list-style-type: none"> <li>• The load inertia is too big.</li> <li>• The torque limit is too low.</li> <li>• The motor parameters are wrong.</li> </ul>	<ul style="list-style-type: none"> <li>• Check the load.</li> <li>• Set the torque limit to the most appropriate setting (L7-01 through L7-04).</li> <li>• Check the motor parameters.</li> </ul>
Control Circuit Fault [PF02 to [PF24		○	There is a problem in the drive's control circuit.	<ul style="list-style-type: none"> <li>• Cycle the drive power supply.</li> <li>• Initialize the drive.</li> <li>• Replace the drive if the fault occurs again.</li> </ul>
Control Circuit Fault [PF25		○	There is no terminal board connected to the control board.	<ul style="list-style-type: none"> <li>• Check if the terminal board is installed properly.</li> <li>• Uninstall and Reapply the terminal board.</li> <li>• Change the drive.</li> </ul>
Cannot Reset Cr5f	○		Fault reset was input when a Run command was active.	Turn off the Run command and reset the drive.
Option External Fault EF	○	○	An external fault was tripped by the upper controller via an option card.	<ul style="list-style-type: none"> <li>• Remove the fault cause, reset the fault and restart the drive.</li> <li>• Check the upper controller program.</li> </ul>
External Fault EF	○		A forward and reverse command were input simultaneously for longer than 500 ms. This alarm stops a running motor.	<ul style="list-style-type: none"> <li>• Check the sequence and make sure that the forward and reverse input are not set at the same time.</li> </ul>

LED Display	AL	FLT	Cause	Corrective Action
External Faults EFF1 to EFF6	○	○	<ul style="list-style-type: none"> <li>An external fault was triggered by an external device via one of the digital inputs S1 to S6.</li> <li>The digital inputs are set up incorrectly.</li> </ul>	<ul style="list-style-type: none"> <li>Find out why the device tripped the EF. Remove the cause and reset the fault.</li> <li>Check the functions assigned to the digital inputs.</li> </ul>
Ground Fault GF		○	<ul style="list-style-type: none"> <li>Ground leakage current has exceeded 50 % of the drives rated output current.</li> <li>Cable or motor insulation is broken.</li> <li>Excessive stray capacitance at drive output.</li> </ul>	<ul style="list-style-type: none"> <li>Check the output wiring and the motor for short circuits or broken insulation. Replace any broken parts.</li> <li>Reduce the carrier frequency.</li> </ul>
Safe Disable Hbb	○		Both Safe Disable inputs are open. The drive output is safely disabled and the motor can not be started.	<ul style="list-style-type: none"> <li>Check why the upper controller's safety device disabled the drive. Remove the cause and restart.</li> <li>Check the wiring.</li> <li>If the Safe Disable function is not utilized for EN60204-1, stop cat. 0 or for disabling the drive, the terminals HC, H1, H2 must be linked.</li> </ul>
Safe Disable Fault HbbF		○	<p>Drive output is disabled while only one of the Safe Disable inputs is open. (normally both input signals H1 and H2 should be open)</p> <ul style="list-style-type: none"> <li>One channel is internally broken and does not switch off, even if the external signal is removed.</li> <li>Only one channel is switched off by the upper controller.</li> </ul>	<ul style="list-style-type: none"> <li>Check the wiring from the upper controller and make sure that both signals are set correctly by the controller.</li> <li>If the signals are set correctly and the alarm does not disappear, replace the drive.</li> </ul>
Output Phase Loss PF		○	<p>Output cable is disconnected or the motor winding is damaged.</p> <p>Loose wires at the drive output.</p> <p>Motor is too small (less than 5 % of drive current).</p>	<ul style="list-style-type: none"> <li>Check the motor wiring.</li> <li>Make sure all terminal screws in the drive and motor are properly tightened.</li> <li>Check the motor and drive capacity.</li> </ul>
Overcurrent OL		○	<p>Short circuit or ground fault on the drive output side</p> <p>The load is too heavy.</p> <p>The accel./decel. times are too short.</p> <p>Wrong motor data or V/f pattern settings.</p> <p>A magnetic contactor was switched at the output.</p>	<ul style="list-style-type: none"> <li>Check the output wiring and the motor for short circuits or broken insulation. Replace the broken parts.</li> <li>Check the machine for damages (gears, etc.) and repair any broken parts.</li> <li>Check the drive parameter settings.</li> <li>Check the output contactor sequence.</li> </ul>
Heatsink Overheat OH or OH1	○	○	<p>Surrounding temperature is too high.</p> <p>The cooling fan has stopped.</p> <p>The heatsink is dirty.</p> <p>The airflow to the heatsink is restricted.</p>	<ul style="list-style-type: none"> <li>Check the surrounding temperature and install cooling devices if necessary.</li> <li>Check the drive cooling fan.</li> <li>Clean the heatsink.</li> <li>Check the airflow around the heatsink.</li> </ul>
Motor Overload OL1		○	<p>The motor load is too heavy.</p> <p>The motor is operated at low speed with heavy load.</p> <p>Cycle times of accel./ decel. are too short.</p> <p>Incorrect motor rated current has been set.</p>	<ul style="list-style-type: none"> <li>Reduce the motor load.</li> <li>Use a motor with external cooling and set the correct motor in parameter L1-01</li> <li>Check the sequence.</li> <li>Check the rated current setting.</li> </ul>

## 8 Troubleshooting

LED Display	AL	FLT	Cause	Corrective Action
Drive Overload OL2		○	The load is too heavy. The drive capacity is too small. Too much torque at low speed.	<ul style="list-style-type: none"> <li>• Check the load.</li> <li>• Make sure that the drive is big enough to handle the load.</li> <li>• The overload capability is reduced at low speeds. Reduce the load or increase the drive size.</li> </ul>
DC Overvoltage OU	○	○	DC bus voltage rose too high. The deceleration time is too short. Stall prevention is disabled. Braking chopper / resistor broken. Unstable motor control. Too high input voltage.	<ul style="list-style-type: none"> <li>• Increase the deceleration time.</li> <li>• Enable stall prevention by parameter L3-04.</li> <li>• Make sure the braking resistor and braking chopper are working correctly.</li> <li>• Check motor parameter settings and adjust torque and slip compensation, AFR and hunting prevention as needed.</li> <li>• Make sure that the power supply voltage meets the drives specifications.</li> </ul>
Input Phase Loss LF		○	Input voltage drop or phase imbalance. One of the input phase is lost. Loose wires at the drive input.	<ul style="list-style-type: none"> <li>• Check the power supply.</li> <li>• Make sure that all cables are properly fixed to the correct terminals.</li> </ul>
Braking Transistor Fault rr		○	The internal braking transistor is broken.	<ul style="list-style-type: none"> <li>• Cycle the power supply.</li> <li>• Replace the drive if the fault reoccurs.</li> </ul>
DC Undervoltage UV1	○	○	The voltage in the DC bus fell below the undervoltage detection level (L2-05). The power supply failed or one input phase has been lost. The power supply is too weak.	<ul style="list-style-type: none"> <li>• Check the power supply.</li> <li>• Make sure, that the power supply is strong enough.</li> </ul>
Controller Undervoltage UV2		○	The drives controller power supply voltage is too low.	<ul style="list-style-type: none"> <li>• Cycle power to the drive. Check if the fault reoccurs.</li> <li>• Replace the drive if the fault continues to occur.</li> </ul>
DC Charge Circuit Fault UV3		○	The charge circuit for the DC bus is broken.	<ul style="list-style-type: none"> <li>• Cycle power to the drive. Check if the fault reoccurs.</li> <li>• Replace the drive if the fault reoccurs.</li> </ul>



### ◆ Operator Programming Errors

An Operator Programming Error (OPE) occurs when an inapplicable parameter is set or an individual parameter setting is inappropriate. When an OPE error is displayed, press the ENTER button to display U1-18 (OPE fault constant). This monitor will display the parameter that is causing the OPE error.

LED Operator Display	Cause	Corrective Action
oPE01 oPE01	Drive capacity and value set to o2-04 do not match.	Correct the value set to o2-04.
oPE02 oPE02	Parameters were set outside the allowable setting range.	Set parameters to the proper values.
oPE03 oPE03	A contradictory setting is assigned to multi-function contact inputs H1-01 through to H1-06. <ul style="list-style-type: none"> <li>• The same function is assigned to two inputs. (this excludes “External fault” and “Not used”)</li> <li>• Input functions which require the setting of other input functions were set alone.</li> <li>• Input functions that are not allowed to be used simultaneously have been set.</li> </ul>	<ul style="list-style-type: none"> <li>• Fix any incorrect settings.</li> <li>• Refer to the Technical Manual for more details.</li> </ul>
oPE05 oPE05	<ul style="list-style-type: none"> <li>• The run command source (b1-02) or frequency reference source (b1-01) is set to 3 but no option board is installed.</li> <li>• The frequency reference source is set to pulse input but H6-01 is not 0.</li> </ul>	<ul style="list-style-type: none"> <li>• Install the required option board.</li> <li>• Correct the values set to b1-01 and b1-02.</li> </ul>
oPE07 oPE07	Settings to multi-function analog inputs H3-02 and H3-10 and PID functions conflict. <ul style="list-style-type: none"> <li>• H3-02 and H3-10 are set to the same value. (this excludes settings “0” and “F”)</li> <li>• PID functions have been assigned to both analog inputs and the pulse input at the same time.</li> </ul>	<ul style="list-style-type: none"> <li>• Fix any incorrect setting.</li> <li>• Refer to the Technical Manual for more details.</li> </ul>
oPE08 oPE08	A function has been set that cannot be used in the control mode selected. (might appear after control mode change)	<ul style="list-style-type: none"> <li>• Fix any incorrect setting.</li> <li>• Refer to the Technical Manual for more details.</li> </ul>
oPE10 oPE10	The V/f pattern setting is incorrect.	<ul style="list-style-type: none"> <li>• Check the V/f pattern settings.</li> <li>• Refer to the Technical Manual for more details.</li> </ul>

## 8 Troubleshooting

---

---

## Revision History

The revision dates and numbers of the revised manuals are given on the bottom of the back cover.

MANUAL NO. TOEP C710606 46A

Published in Japan June 2011 11-06 

└─ Date of publication  
└─ Date of original publication  
└─ Revision number

Date of Publication	Rev. No.	Section	Revised Content
June 2011	–	–	First edition



# YASKAWA AC Drive V1000

1000Hz Software

## Quick Start Guide

---

### EUROPEAN HEADQUARTERS

YASKAWA EUROPE GmbH

Hauptstraße 185, 65760 Eschborn, Germany

Phone: +49 (0)6196 569 300 Fax: +49 (0)6196 569 398

E-mail: [info@yaskawa.eu.com](mailto:info@yaskawa.eu.com) Internet: <http://www.yaskawa.eu.com>

### U.S.A.

YASKAWA AMERICA, INC.

2121 Norman Drive South, Waukegan, IL 60085, U.S.A.

Phone: +1 847 887 7000 Fax: +1 847 887 7370

Internet: <http://www.yaskawa.com>

### JAPAN

YASKAWA ELECTRIC CORPORATION

New Pier Takeshiba South Tower, 1-16-1, Kaigan, Minatoku, Tokyo, 105-0022, Japan

Phone: +81 (0)3 5402 4511 Fax: +81 (0)3 5402 4580

Internet: <http://www.yaskawa.co.jp>



YASKAWA ELECTRIC CORPORATION

In the event that the end user of this product is to be the military and said product is to be employed in any weapons systems or the manufacture thereof, the export will fall under the relevant regulations as stipulated in the Foreign Exchange and Foreign Trade Regulations. Therefore, be sure to follow all procedures and submit all relevant documentation according to any and all rules, regulations and laws that may apply.

Specifications are subject to change without notice for ongoing product modifications and improvements.

© 2011 YASKAWA ELECTRIC CORPORATION. All rights reserved.

MANUAL NO. TOEP C710606 46A\_0\_0

Published in Japan September 2012 11-06