



# AC<sup>3</sup> System Installation Manual



COMPANY WITH  
MANAGEMENT SYSTEM  
CERTIFIED BY DNV GL  
= ISO 9001 =  
= OHSAS 18001 =

Installation Manual  
M.I. AC3-1a/15.01  
Code: ISTR-MI AC3ENG01a



Copyright ©, 2014 Ascon Technologic S.r.l.

All rights reserved

No part of this document may be stored in a retrieval system, or transmitted in any form, electronic or mechanical, without prior written permission of Ascon Technologic S.r.l..

Ascon Technologic has used the best care and effort in preparing this manual and believes that the information contained in this publication is accurate.

As Ascon Technologic continues to improve and develop products, the information contained in this manual may also be subject to change. Ascon Technologic reserves the right to change such information without notice.

Ascon Technologic makes no warranty of any kind, expressed or implied, with regard to the documentation contained in this manual.

Ascon Technologic shall not be liable in any event - technical and publishing error or omissions - for any incidental and consequential damages, in connection with, or arising out of the use of this manual.

*sigmadue*<sup>®</sup>, *gammadue*<sup>®</sup> and *deltadue*<sup>®</sup>, are trademarks of Ascon Technologic Srl.

All other trade names or product names are trademarks or registered trademarks.

## **Ascon Technologic srl**

**Headquarters:** viale Indipendenza 56,  
27029 Vigevano (PV)

**Phone:** +39 0381 69871

**Fax:** +39 0381 698730

**Internet Site:** [www.ascontecnologic.com](http://www.ascontecnologic.com)

**E-mail address:** [info@ascontecnologic.com](mailto:info@ascontecnologic.com)

---

# INDEX

---

## Chapter 1

<b>Product Description</b> .....	<b>1</b>
1-1 AC3 Hardware .....	1
1-1-1 Types of installation .....	1
1-1-2 Order code .....	2
1-2 Physical dimensions .....	3
1-2-1 System dimensions .....	3
1-3 Panel Cutout .....	5
1-3-1 Panel Cutout dimensions and space .....	5
1-4 Installing the Hardware .....	5
1-4-1 Front Panel Installation .....	5
1-4-2 Remote Installation .....	6

## Chapter 2

<b>Hardware Description</b> .....	<b>11</b>
2-1 Technical specification .....	11
2-1-1 AC3 System Assembly .....	11
2-1-2 P04 Operator Panel .....	12
2-1-3 MP-02 CPU .....	13
2-1-4 Installation Kit .....	14
2-2 Hardware Description .....	16
2-2-1 P04 Operator Panel .....	16
2-2-2 MP-02 CPU .....	17
2-2-3 AC3 System - AC-Station Compatibility I/O Assignment Table .....	20
2-2-4 Diagnostic LEDs .....	21

## **Chapter 3**

<b>Electrical Connections</b> .....	<b>23</b>
3-1 Electric safety and electromagnetic compatibility .....	23
3-1-1 How to increase the electromagnetic immunity .....	23
3-2 Installation Precautions and Notes .....	24
3-2-1 B Installation Precautions .....	24
3-2-2 Installation Notes .....	24
3-3 Power Supply Connections .....	24
3-3-1 P04 Power Supply .....	24
3-3-2 MP-02 Power Supply .....	24
3-4 Analogue Input Connections .....	25
3-4-1 2-3 Wires WTrasmitters Input .....	25
3-4-2 Voltage Input .....	25
3-4-3 mA Input .....	25
3-4-4 J, K, L, N, R, S, T thermocouple type input (with AI-UI opt.) .....	26
3-4-5 Pt100, Pt1000 (2, 3, 4 wires) input (with AI-UI opt.) .....	26
3-4-6 mV input (with AI-UI opt.) .....	26
3-4-7 Potentiometer input (with AI-UI opt.) .....	26
3-4-8 High level inputs (with AI-HL opt.) .....	27
3-5 Digital Input Connections .....	27
3-5-1 Digital Inputs 1...8 Type II (EN61131-2) .....	27
3-5-2 Digital Inputs 1...8 Type II (EN61131-2) .....	27
3-6 Analogue Output Connections .....	28
3-6-1 Analogue outputs 1... 4 (opt.) .....	28
3-7 Digital Output Connections .....	28
3-7-1 Digital Output 1...8 (PNP) Source Type .....	28
3-8 Communications connections .....	28
3-8-1 X0 port RS232/485 Service/Modbus Port connector .....	28
3-8-2 RS485 Modbus Port connector .....	29
3-8-3 LAN - Ethernet TCP/IP port connector .....	30

## **Chapter 4**

<b>Replacing the RTC Battery</b> .....	<b>31</b>
--	-----------

## **Appendix A**

<b>Accessories</b> .....	<b>33</b>
A-1 Connection accessories .....	33
A-1-1 11 poles connectors .....	33
A-1-2 14 poles connectors .....	33
A-1-3 Additional terminal block .....	33
A-2 Power Supply .....	34
A-2-1 Power supply 75W - 3A/24Vdc .....	34
A-2-2 Power supply 120W - 5A/24Vdc .....	34
A-3 Disturbance Protection Accesories .....	34
A-3-1 EMC Filter .....	34
A-3-2 EMC Clamp filter .....	34
A-4 Network Connection Accesories .....	35
A-4-1 Ethernet Switch .....	35
A-4-2 RS485 Splitter .....	35

The products described in this manual should be installed, operated and maintained only by qualified personnel who is familiar with automation safety topics and applicable national standards.

## Using this manual

---

Specifications within the text of this manual are given in the International System of Units (SI), with non SI equivalents in parentheses.

Fully Capitalized words within the text indicate markings found on the equipment.

Words **in bold** style within the text indicate markings found in the Configuration Tools.

Warnings, Cautions and Notes are used to emphasize critical instructions:



### **DANGER!**

Indicates an imminently hazardous situation which, if not avoided, will result in death or serious injury.

---



### **WARNING**

Indicates a potentially hazardous situation which, if not avoided, could result in death or serious injury.

---



### **Caution**

Indicates a potentially hazardous situation which, if not avoided, may result in minor or moderate injury, or property damage.

---

**Note:** Highlights important information about an operating procedure or the equipment.

## General warnings

---



### **DANGER!**

Whenever a failure or a malfunction of the device may cause dangerous situations for persons, things or animals, please remember that the plant must be equipped with additional devices which will guarantee safety.

---



### **WARNING**

We warrant that the products will be free from defects in material and workmanship for 18 months from the date of delivery. Products and components that are subject to wear due to conditions of use, service life and misuse are not covered by this warranty.

---

## Current Documentation on the Internet

---

Make sure you are always working with the latest version of this document.

Ascon Tecnologic S.r.l. reserves the right to make changes to its products in the name of technological advancement.

New manual revisions, when published, and can be found online at:

<http://www.ascontecnologic.com>

### 1-1 AC<sup>3</sup> Hardware

---

The AC<sup>3</sup> system has been specifically projected to substitute the AC Station controller, but can also be used as a normal Multiloop control system.

The main components of an AC<sup>3</sup> system are:

- P04 Operator Panel;
- MP-02 CPU;
- An Ethernet cable to connect the CPU to the Operator Panel;
- Mounting kit (a plastic adapter to install the P04 into the cutout made for the AC-Station, a metal plate to mount the CPU MP-02 and two metal clamps to fit the structure to the front panel of the cabinet).

Additional (optional) components of the AC<sup>3</sup> system:

- Up to two expansion modules also in a mixed configuration of:
  - MP-D1/08-08 module coming with 8 Digital Inputs and 8 Digital Outputs;
  - MP-D1/16-16 module coming with 16 Digital Inputs and 16 Digital Outputs;
  - MP-D2/08-08 module coming with 8 Digital Inputs and 8 Relay Outputs;
  - MP-D4/08-08 module coming with 8 High Level (120 VAC) Digital Inputs and 8 Relay Outputs.
- Optional accessories:
  - 24 Vdc 5 A Power supply (APS2ALDR12024);
  - 6 ports 10/100/1000 Ethernet Switch (APS2ATOPEH2306);
  - RS485 splitter with RJ45 connectors (APS2LOCALBUSDUPLEX).

#### 1-1-1 Types of installation

There are 2 different ways to install an AC<sup>3</sup> system:

- Front panel (or Standard) mounting;
- Remote installation (the P04 and the CPU will be installed far from each other).

In both cases the communications between the P04 Operator Panel and the MP-02 CPU are established by the Ethernet connection.

When the AC<sup>3</sup> replaces an AC-Station (or is Standard mounted), the dedicated adapter and the installation plate must be present in the order, otherwise the plate would not be necessary.

Sometimes the Standard mounting solution cannot be used due to the overall dimensions of the system.

The following table shows the installation options.

AC <sup>3</sup> system configuration	Installation type
PO04 + MP-02	Standard and Remote solution with "Short plate"
PO04 + MP-02 + 1 single expansion module	All installation types possible, the Front Panel mounting uses the "Long installation plate"
PO04 + MP-02 + 2 single expansion modules	
PO04 + MP-02 + 1 double expansion module	
PO04 + MP-02 + 1 single expansion module + 1 double expansion module	Only the Remote installation mode is available with this configurations
PO04 + MP-02 + 2 double expansion modules	

### 1-1-2 Order code

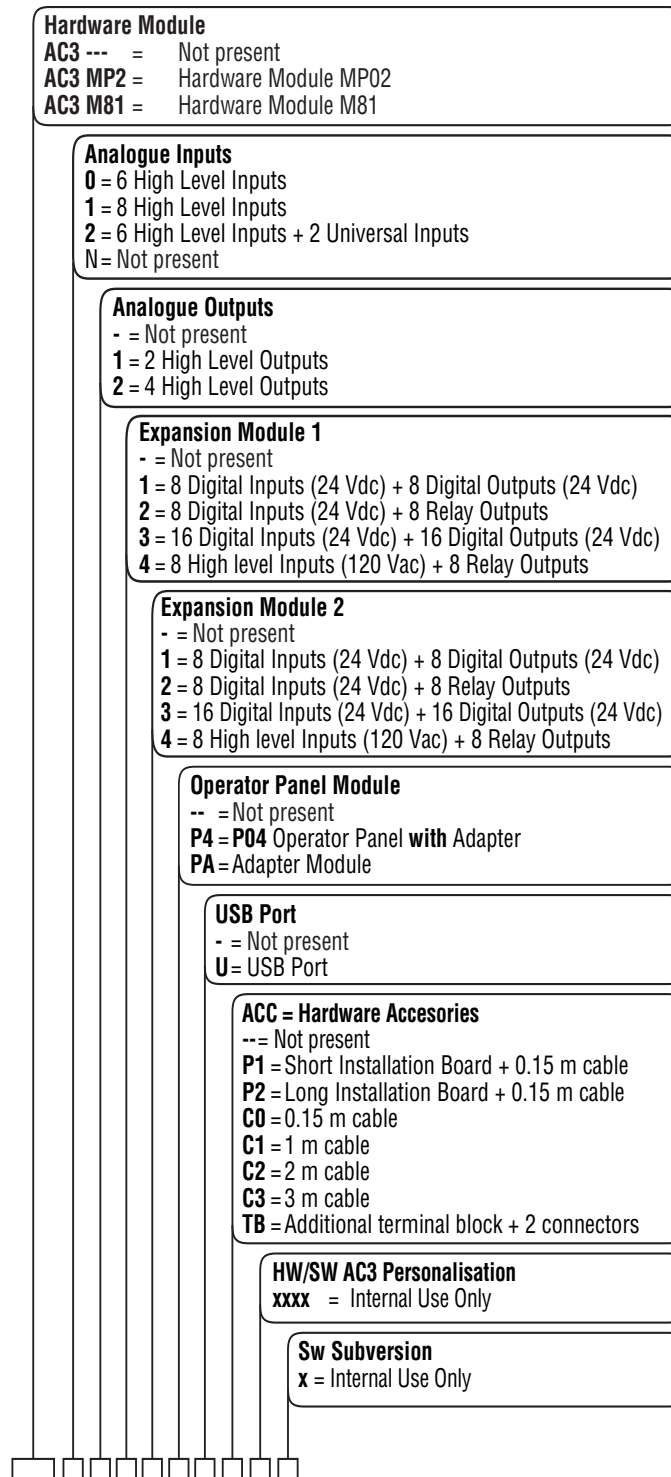



## 1-2 Physical dimensions

### 1-2-1 System dimensions

*Standard mounting* When installing the System for the Standard mounting mode, it can use two different mounting plates depending on the number of expansion modules that are to be installed.

#### Dimensions with the display adapter and the short mounting plate

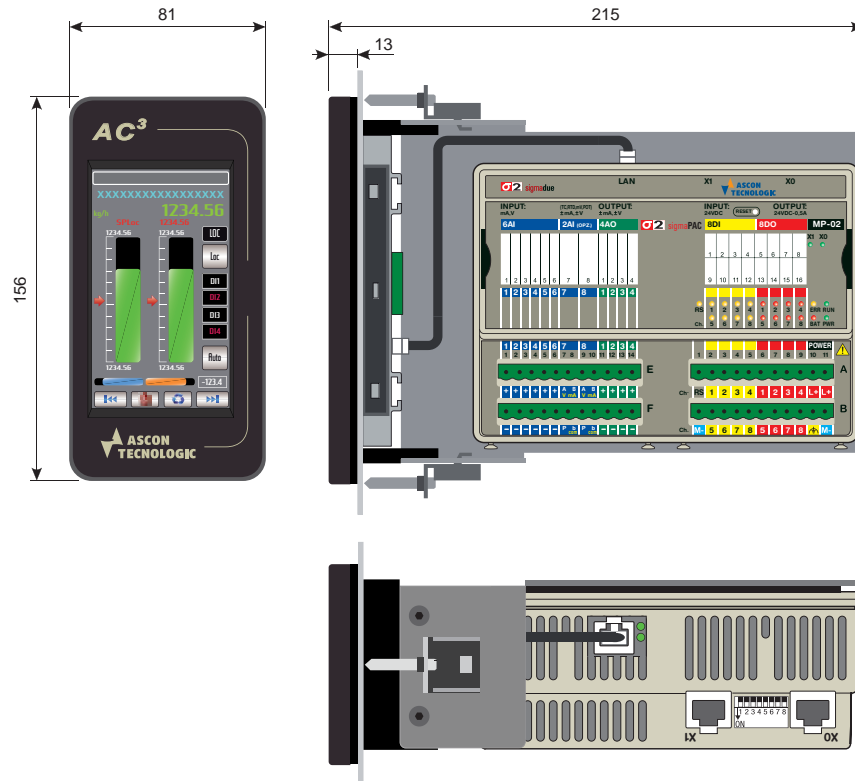

#### Dimensions with the display adapter and the long mounting plate

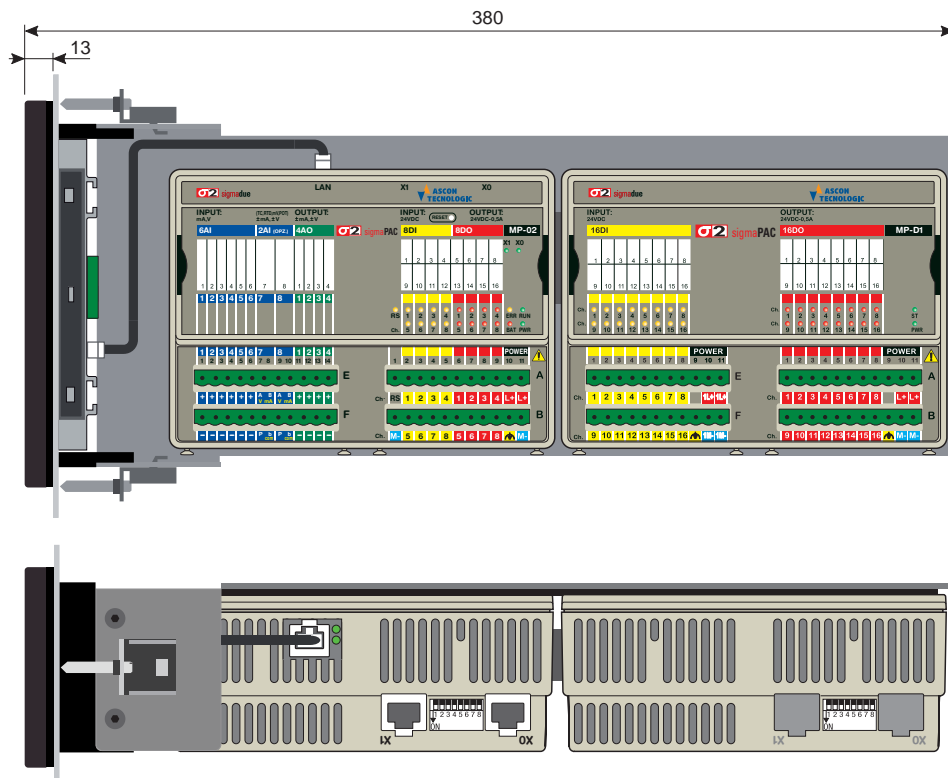

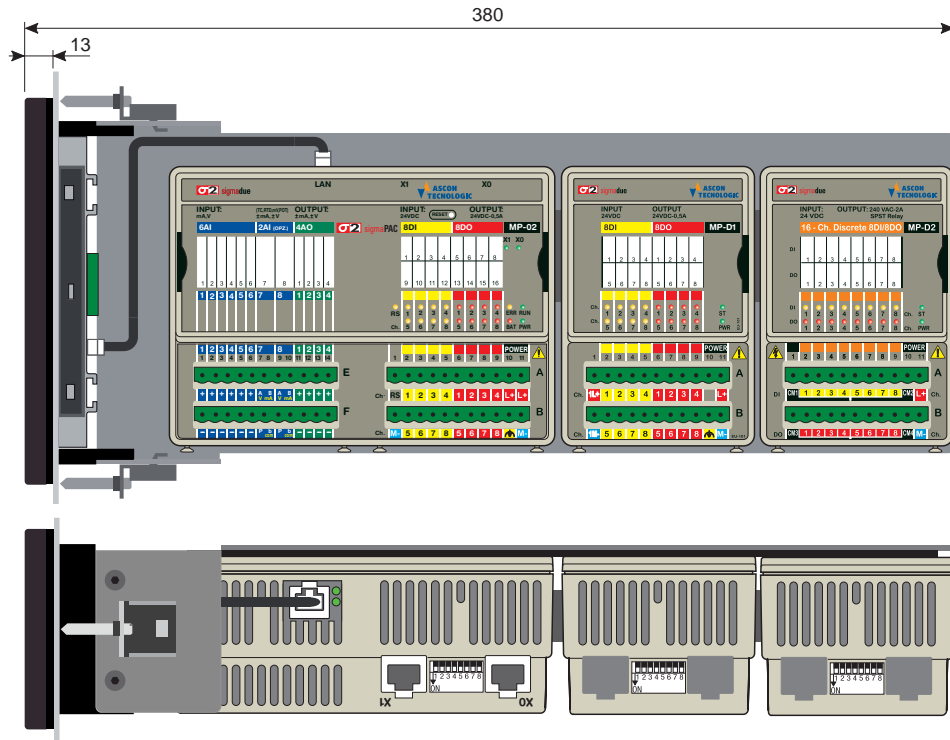

**Remote mounting** When installing the System for Remote mounting, it can be considered as composed by two distinct pieces:

- The P04 Operator Panel (with the Cutout adapter);
- The MP-02 CPU with the expansion modules.

**Dimensions of the P04 Operator Panel with the Cutout adapter**

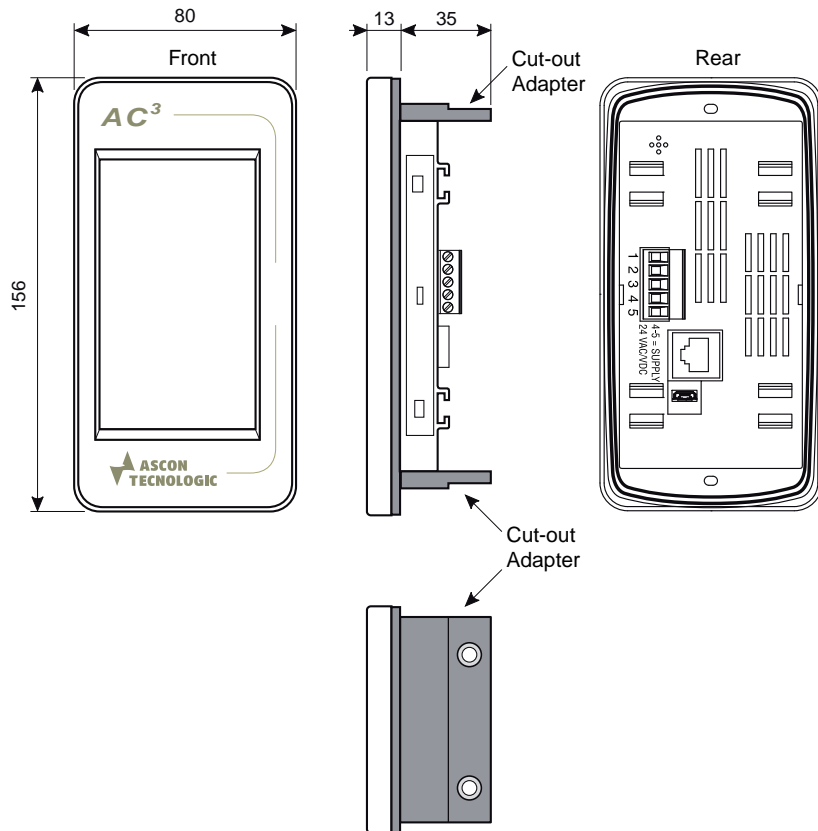

## 1-3 Panel Cutout

### 1-3-1 Panel Cutout dimensions and space

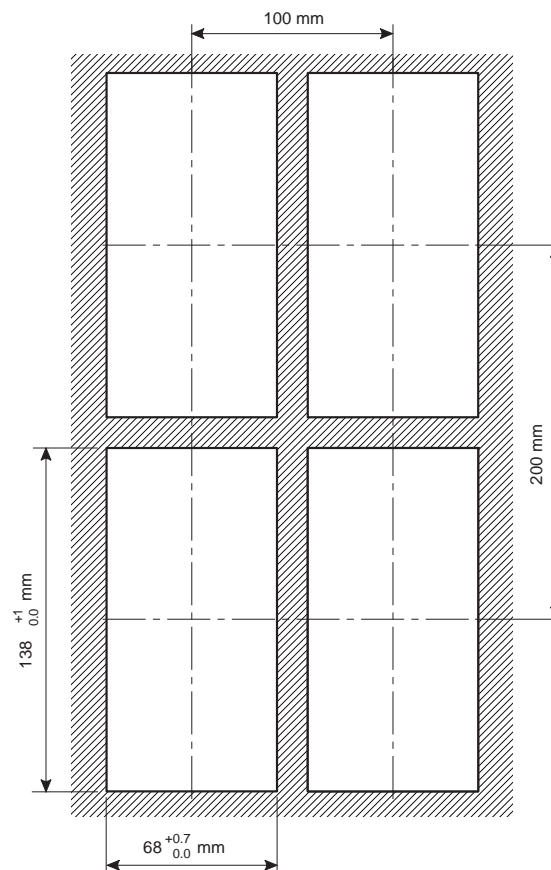

## 1-4 Installing the Hardware

### 1-4-1 Front Panel Installation

The Front Panel installation of an AC<sup>3</sup> system is quite simple:

- Insert the System in the cutout made on the front panel of the cabinet;

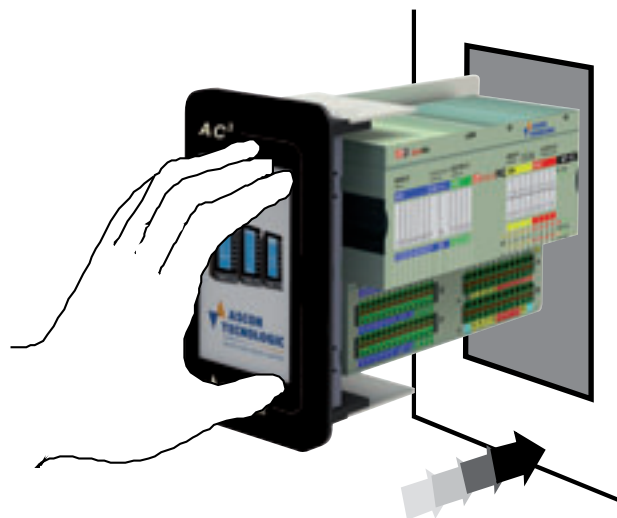

- Fit the two mounting clamps, fixing them in the slots at the top and bottom side of the the metal plate. To hook the clamps, slide them away from the panel;

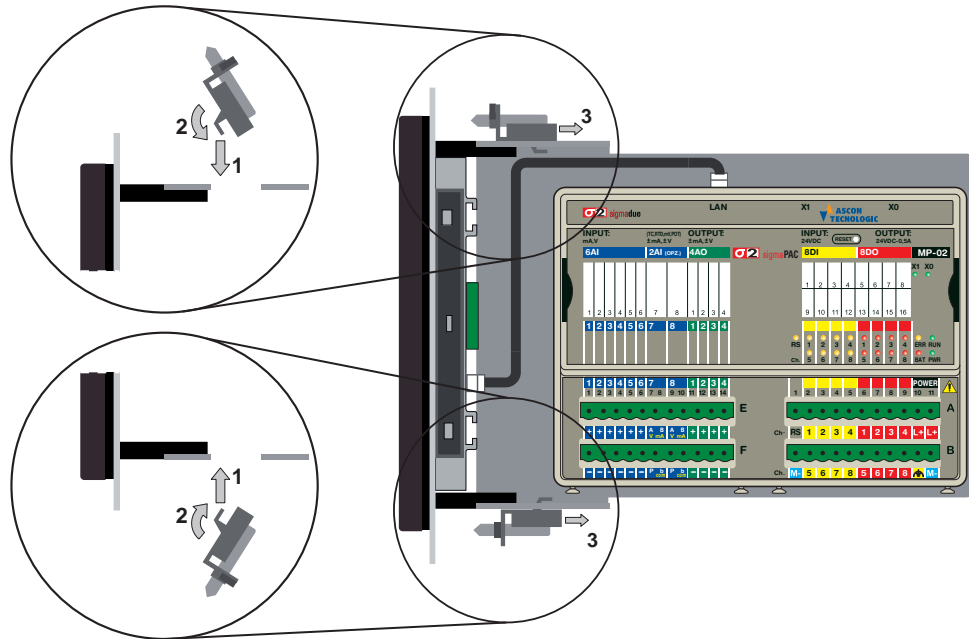

- Rotate clockwise the clamps screws until the instrument is firmly locked to the cabinet panel. Do not over tighten the screws, to avoid panel distortions.

#### 1-4-2 Remote Installation

The Remote installation of an AC<sup>3</sup> system requires a little more time:

- Insert the System with the adapter in the cutout made on the front panel of the cabinet;

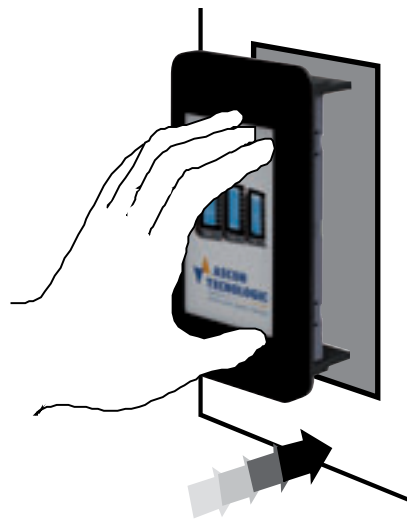

- Insert the four mounting clamps, in the rear side of the P04 Operator Panel as illustrated;

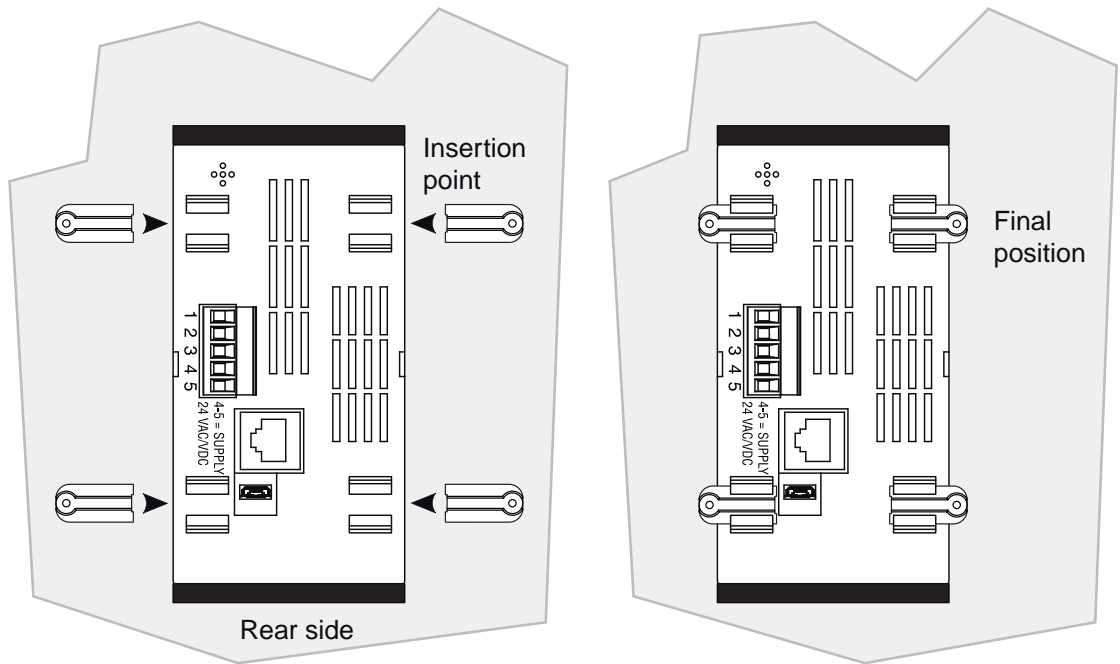

- Now mount a retaining screw in the hole present in each clamp;

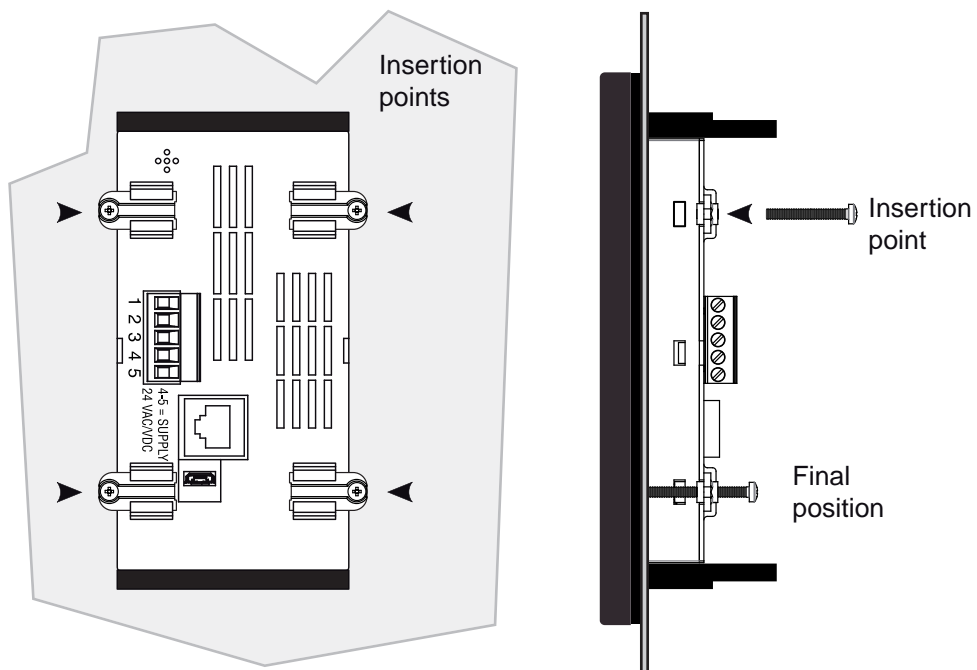

- Rotate clockwise the four clamps screws until the instrument is firmly locked to the cabinet panel. Do not over tighten the screws, to avoid panel distortions;
- The MP-02 CPU and the expansion modules must be mounted on the dedicated DIN rail located in the same cabinet or, in a remote installation) in a different one. The Operator Panel and the CPU communicate through the Ethernet cable.

### Installing the modules on a DIN rail

#### Mounting Position

Select a mounting position in accordance with the distances indicated in the illustration that follows:

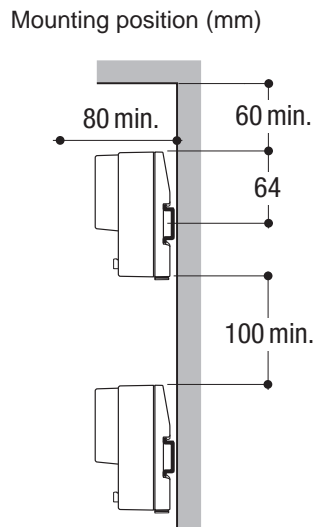

- Mount the modules vertically;
- In order to help the air ventilation flow, respect the distances between modules and walls.

#### Mounting/Removing the modules on/from the DIN rail

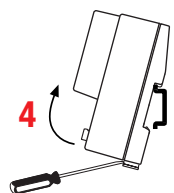
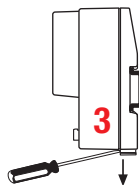
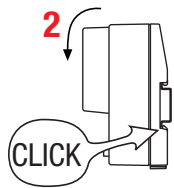
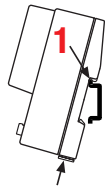

#### Mounting Instructions

1. Close the spring slide, then clip the upper part of the module on the rail;
2. Rotate the module downwards till to the click;

#### Removing Instructions

##### Switch OFF the Power Supply;

3. Lower the spring slide by inserting a flat-blade screwdriver as indicated;
4. Turn and lift the module upwards.

### Connecting the expansion modules

The I/O modules are already set.

The I/O expansion modules (max. 2) must be mounted on the right of the last mounted module.

The modules (CPU included) must be powered OFF when connected to each other.

All the modules must be removed from the DIN rail before to connect or disconnect the bus.

1. Switch OFF the Power Supply;
2. Insert the connector of the bus in the rightmost module. A position key identifies the insertion versus of the connector;
3. Mount the modules on the DINrail.

To remove the I/O expansion modules invert the mounting sequence described.

### 2-1 Technical specification

---

#### 2-1-1 AC<sup>3</sup> System Assembly

The AC<sup>3</sup> System is composed by a P04 Touch Screen Panel device and an MP-02 Control Unit. The system, optionally, can be installed as splitted version where the P04 Panel can be installed remotely from the MP-02 Unit.

The data exchange between the two devices is performed through an Ethernet Communications.



## 2-1-2 P04 Operator Panel

### Display characteristics

Item	Description
LCD type	TFT display
Screen dimension	4.3"
Screen format	16/9
Touch-screen	Resistive
Resolution	480 x 272
Number of colours	262 k
Back light	LED

### Storage characteristics

Item	Description
RAM	128 MB
Flash	128 MB (Operating System + Program + 16 MB user space)
Memory card	MicroSD (max. capacity 8GB)
USB	2.0 full speed (max. distance <3 m)

### Communication characteristics

Item	Description
Ethernet	10/100Mb/s (max. distance <30 m)
RS485	Not available

### Electrical characteristics

Item	Description
Power Supply	24VAC/DC, ±10%
Current consumption	300mA @ 24VDC
Internal fuse	Not available

### Mechanical characteristics

Item	Description
Dimensions (H x L x W)	83 x 159 x 28 mm
Cutout	68 x 138 (P04 with front panel mounting adapter)
	68 x 127 (panel only)
Weight	200 g

### Environmental characteristics

Item	Description
Operating Temperature	0... 55°C
Storage Temperature	-20... +60°C
Relative Humidity	85% RH
Protection degree	Front panel: IP65, Rear side: IP20
CE standards	EN61151-3, 61000-3-3:1995+A1:2001+A2:2005



## 2-1-3 MP-02 CPU

*CPU specifications*

Item	Description
<b>Processor</b>	32 bit ARM
<b>Program memory</b>	2 MB Flash
<b>Dynamic memory</b>	16 MB RAM
<b>Retentive memory</b>	64 kB redundant (32 kB + 32 kB)
<b>Memory data retention</b>	10 years (with replaceable battery)
<b>Real Time Clock</b>	Available
<b>Timer resolution</b>	1 ms max.
<b>Computing speed</b>	70 Mips
<b>Min. cycle time</b>	≥5ms (typical 10ms)
<b>Min. response time</b>	Inputs Acquisition + cycles execution time
<b>Communications port</b>	Ethernet 10 Mb base T
<b>Communications ports</b>	1 RS485 + 1 RS232/485 selectable
<b>Front LEDs</b>	For digital I/Os, communication ports and CPU diagnostic

*General and environmental specifications*

Item	Description
<b>Power supply voltage</b>	24 VDC (-15... +25%)
<b>Power consumption</b>	10 W (+5 W with both the expansions)
<b>Reverse polarity protection</b>	Standard
<b>Isolation class</b>	II (50 Vrms), EN61010-1
<b>Vibration resistance</b>	10...57 Hz, 0.0375mm, 57...150 Hz, 0.5 g (3 axis)
<b>Shock resistance</b>	15 g
<b>Operating temperature</b>	0...55°C; (humidity: 5... 95%)
<b>Storage temperature</b>	-40...70°C
<b>Protection</b>	IP20

*High level analogue inputs*

Item	Description
<b>6 configurable</b>	0... 10 V, 0/1... 5 V, 0... 1 V - 0/4... 20 mA
<b>2 optional configurable</b>	±10 V, ±5 V, ±1 V, 0/4... 20 mA
<b>Acquisition time</b>	Standard inputs: 170 ms, optional inputs: 40 ms
<b>Resolution</b>	16 bit
<b>Accuracy</b>	0.1%
<b>Input impedance</b>	>100 kΩ (V); 300 Ω (mA)
<b>Isolation</b>	800 V between Power supply and logics

*Universal analogue inputs*

Item	Description
<b>2 optional configurable</b>	±50 mV, ±100 mV, ±300 mV, ±1.25 V high impedance, TC (L, J, T, K, S, R, B, N, E, W3, W5), Pt100 (3 wire), Pt1000 and potentiometer (0.1... 10 kΩ)
<b>Acquisition time</b>	60 ms
<b>Resolution</b>	16 bit
<b>Accuracy</b>	0.1%
<b>Input impedance</b>	10 MΩ (V)
<b>Cold junction compensation Isolation</b>	≤1°C/20°C ambient temperature 800 V between Power supply and logics 40 Vpp between the 2 channels (differential inputs)

Analogue  
Outputs

Item	Description
<b>0/2/4 optional configurable</b>	±10 V (±25 mA max.), 0/4... 20 mA
<b>Update time</b>	35 ms
<b>Resolution</b>	13 bit
<b>Accuracy</b>	0.1%
<b>Isolation</b>	800 V between Power supply and logics

## Digital Inputs

Item	Description
<b>8... 40 with expansions</b>	24 VDC (On: 5... 30 V, Off: 0... 3 V)
<b>Max. input frequency</b>	80 Hz
<b>Type</b>	Sink
<b>Protection</b>	Reverse polarity and overvoltage
<b>Isolation</b>	800 V between Power supply and logics
<b>Compliance</b>	IEC/EN 61131-2 (type 2)

## Digital Outputs

Item	Description
<b>8... 40 with expansions</b>	24VDC, 0.5 A
<b>Type</b>	Source (PNP)
<b>Protection</b>	Overvoltage and short circuit
<b>Isolation</b>	800V between Power supply and logics

## 2-1-4 Installation Kit

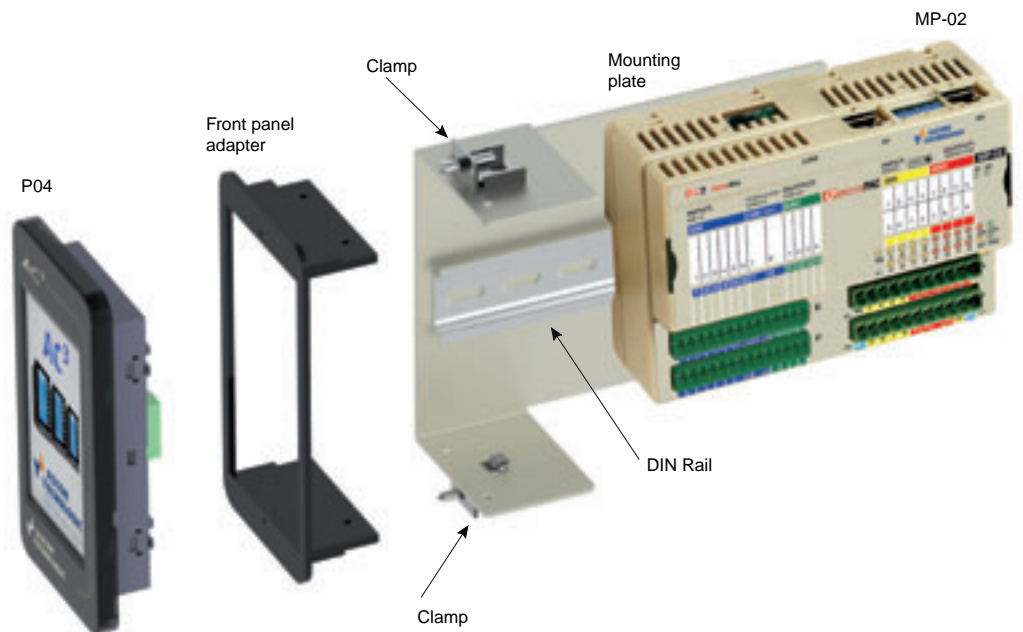

The installation kit is a mandatory item when the AC<sup>3</sup> System is to be installed in place of an AC Station or Front Panels mounted.



It consists of some hardware parts to allow the front panel installation:

- Front panel Adapter;
- 2 Allen screws to install the P04 touch screen display in the front panel adapter;
- Mounting plate with a DIN rail that allows the installation of the MP-02;
- 4 conical head Allen screws to assemble the mounting plate to the front panel adapter.
- 2 clamps to fix the structure to the font panel.

## Mechanical characteristics

Item	Description
<b>Dimensions (H x L x W)</b>	156 x 81 x 215 (380) mm short plate (long plate)
<b>Cutout</b>	68 x 138 (P04 with front panel mounting adapter)
<b>Weight</b>	Sort plate 730 g; long plate: 1200 g

## Terminal specifications

Description		Plugs A and B terminals		Plugs A and B terminals	
Flexible cable section:		0.2... 2.5 mm <sup>2</sup> (AWG24... AWG12)		0.08...1.5 mm <sup>2</sup> (AWG28... AWG16)	
	Stripped wire	<b>Screw:</b> 7mm; <b>Spring:</b> 10mm		<b>Screw:</b> 7mm; <b>Spring:</b> 10mm	
	Flat blade screwdriver	0.6 x 3.5 mm	0.4 x 2.5 mm		
	Tightening torque	0.5...0.6 Nm		0.4...0.5 Nm	

## Technical data:

- Two 11 poles plugs (A and B) pitch 5.0 mm and two 14 poles plugs (E and F) pitch 3.8 mm;
- Made with self extinguishing material as required by UL94 V0 standard;
- Overvoltage category/pollution degree II/2;
- Max. load current/section 8A/2.5mm<sup>2</sup> at 65°C;
- Test pulse voltage: 4 kVp.

**WARNING**

Please note that the maximum current capacity for each terminal is 8A.

**WARNING**

Make sure that the overall current absorption (modules and field devices) matches the power supply.

**WARNING**

In order to avoid excessive voltage drops, install the most power consuming modules closer to the power supply.

## 2-2 Hardware Description

### 2-2-1 P04 Operator Panel

Touch Screen  
Panel



The P04 operator panel is used directly from the Touch Screen Area.

Connections  
and Ports

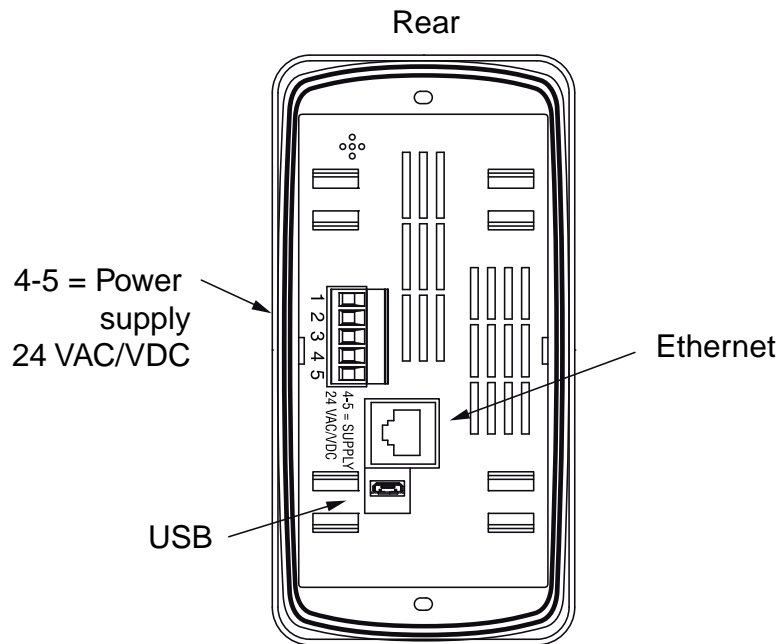

#### Power Supply connection

The power supply is to be provided to the operator panel via terminals 4 and 5 of the terminal block. Since the power required can be both in alternate and in direct current (AC/DC), the polarization of the terminals is not relevant.

#### Ethernet connection

The LAN Ethernet port (TCP/IP) is dedicated to interface the P04 Operator Panel to the MP-02 Control Unit.

#### USB port

The USB port can be used to upload a strategy in the P04 Operator Panel.

## 2-2-2 MP-02 CPU

*Integrated I/Os* The AC<sup>3</sup> system base MP-02 unit has up to 28 I/O ports:

- 6 AI** 6 analogue inputs configurable for mA, V;
- 2 AI** 2 optional universal or high level isolated analogue inputs configurable for:
  - Thermocouples (L, J, T, K, S, R, B, N, E, W3, W5);
  - RTD (PT100, PT1000);
  - $\pm$ mA,  $\pm$ V linear inputs;
  - Potentiometers.
- 4 AO** 4 optional high level analogue outputs;
- RS** RUN/STOP program functionality;
- 8 DI** General Purpose Digital Inputs;
- 8 DO** Isolated General Purpose Digital Outputs.

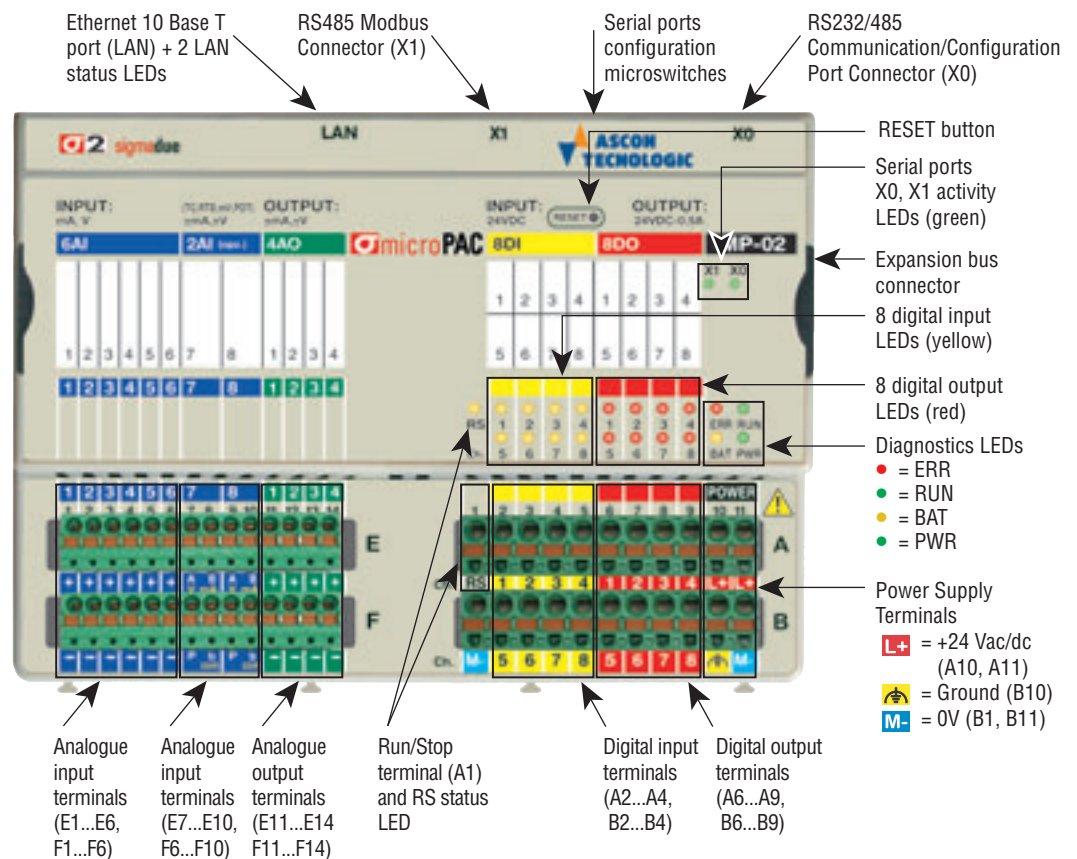

### WARNING

The **RESET** button **does not restart** the CPU or the 1131 application, but **resets all the stored set-up parameters and restores the default parameters** (as well as those set by the user).

**Terminal “A” connections** The “A” terminal block allows the connection of the +24V Power Supply, Run/Stop, 4 Digital Inputs and 4 Digital Outputs Signals.

The terminals are positioned as follows:

Pin	1	2	3	4	5	6	7	8	9	10	11
Label	RS	1	2	3	4	1	2	3	4	L+	L+
Function	Run/Stop	DI1	DI2	DI3	DI4	DO1	DO2	DO3	DO4	POWER	
Signal	INPUT	INPUT	INPUT	INPUT	INPUT	OUT	OUT	OUT	OUT	+24V	+24V
	Run/Stop Digital Input		Digital Input			Digital Output				Power Supply	

- 1 RS** Run/Stop terminal, connecting this terminal to a 24V source, it is possible to launch or stop the execution of the 1131 program loaded in the CPU;
- 2...5 1... 4** 4 Digital Inputs terminals, connecting this terminal to a 24V source, it is possible to change the status of the input;
- 6...9 1... 4** 4 Digital Outputs terminals. Each source type (PNP) digital output can manage a 24V 0.5A load;
- 10...11 L+** 24VDC power supply terminals.

**Terminal “B” connections** The “B” terminal block allows the connection of the 0V Power Supply, 4 Digital Inputs, 4 Digital Outputs Signals and the system hearth.

The terminals are positioned as follows:

Pin	1	2	3	4	5	6	7	8	9	10	11
Label	M-	5	6	7	8	5	6	7	8		M-
Function	POWER	DI5	DI6	DI7	DI7	DO5	DO6	DO7	DO8	Ground	POWER
Signal	0V	INPUT	INPUT	INPUT	INPUT	OUT	OUT	OUT	OUT	Ground	0V
	Power supply	Digital Input			Digital Output				Frame ground	Power supply	

- 1 M-** 0V power supply terminal.
- 2...5 5... 8** 4 Digital Inputs terminals, connecting this terminal to a 24V source, it is possible to change the status of the input
- 6...9 5... 8** 4 Digital Outputs terminals. Each source type (PNP) digital output can manage a 24V 0.5A load.
- 10 ** Frame ground.
- 11 M-** 0V power supply terminal.

**Terminal “E” connections** The “E” terminal block allows the connection of 6 Analogue Inputs, 2 optional Analogue Inputs and 4 Analogue Outputs.

The terminals are positioned as follows:

Pin	1	2	3	4	5	6	7	8	9	10	11	9	10	11
Label	+	+	+	+	+	+	A V	B mA	A V	B mA	+	+	+	+
Function	AI1	AI2	AI3	AI4	AI5	AI6	Univ. AI1		Univ. AI2		AO1	AO2	AO3	AO4
Signal	IN	IN	IN	IN	IN	IN	IN		IN		OUT	OUT	OUT	OUT

Analogue input (mA, V)

Analogue input ( $\pm$ mA,  $\pm$ V) Analogue output ( $\pm$ mA,  $\pm$ V)

- 1...6 +** 6 configurable analogue (linear) input positive (+) poles. These inputs can be configured as mA or V. The negative (-) poles are on connector “F”;
- 7...10 A...B** 2 universal/high level analogue (linear) inputs (No. 7, 8) (see the “MP-02 Installation Manual” for details). The Input number (0... 2) and type can be identified by the order code. The additional terminals of these 2 inputs are on connector “F”;
- 11...14 +** 4 analogue output positive (+) poles. The outputs number (0, 2, 4) is specified by the order code, the type can be set during the **CPU set-up phase** (see the “CPU set-up” chapter on the MP-02 User manual). The negative (-) poles are on connector “F”.

**Terminal “F” connections** The “F” terminal block allows to complete the connections of the I/Os present on the “E” terminal block.

The connector “F” has 14 terminals:

Pin	1	2	3	4	5	6	7	8	9	10	11	12	13	14
Name	-	-	-	-	-	-	P	b com	P	b com	-	-	-	-
Function	AI1	AI2	AI3	AI4	AI5	AI6	Univ. AI1		Univ. AI2		AO1	AO2	AO3	AO4
Signal	IN	IN	IN	IN	IN	IN	IN		IN		OUT	OUT	OUT	OUT

Analogue input (mA, V)

Analogue input ( $\pm$ mA,  $\pm$ V) Analogue output ( $\pm$ mA,  $\pm$ V)

- 1...6 -** 6 configurable analogue (linear) input negative (-) poles;
- 7...10 P...b** 2 universal/high level analogue (linear) inputs (No. 7, 8)(see the “MP-02 Installation Manual” for details);
- 11...14 -** 4 analogue output negative (-) poles.

2-2-3 AC<sup>3</sup> System - AC-Station Compatibility I/O Assignment Table

Tag	AC-Station Terminals	MP-02 Terminals	Meaning
AI_1	1 + / 2 -	E1 + / F1 -	High Level Analogue Input_1
AI_2	3 + / 2 -	E2 + / F2 -	High Level Analogue Input_2
AI_3	4 + / 5 -	E3 + / F3 -	High Level Analogue Input_3
AI_4	6 + / 5 -	E4 + / F4 -	High Level Analogue Input_4
AI_5	7 + / 8 -	E5 + / F5 -	High Level Analogue Input_5
AI_6	9 + / 8 -	E6 + / F6 -	High Level Analogue Input_6
AI_7	10 + / 11 -	E8 + / F8 -	High Level Analogue Input_7
AI_8	12 + / 11 -	E10 + / F10 -	High Level Analogue Input_8
DI_1	13 / 14	A2	Digital Input_1
DI_2	15 / 14	A3	Digital Input_2
DI_3	16 / 17	A4	Digital Input_3
DI_4	18 / 17	A5	Digital Input_4
DI_5	19 / 20	B2	Digital Input_5
DI_6	21 / 20	B3	Digital Input_6
DI_7	22 / 23	B4	Digital Input_7
DI_8	24 / 23	B5	Digital Input_8
+24 VDC_1	25 +	A11 +	24 VDC Power supply
+24 VDC_2	26 +	-	Not Present
AO_1	27 + / 28 -	E11 + / F11 -	Analogue Output_1
AO_2	29 + / 28 -	E12 + / F12 -	Analogue Output_2
AO_3	30 + / 31 -	E13 + / F13 -	Analogue Output_3
AO_4	32 + / 31 -	E14 + / F14 -	Analogue Output_4
DO_1	33 / 34	A6	Digital Output_1
DO_2	35 / 34	A7	Digital Output_2
DO_3	36 / 37	A8	Digital Output_3
DO_4	38 / 37	A9	Digital Output_4
DO_5	39 / 40	B6	Digital Output_5
DO_6	41 / 40	B7	Digital Output_6
DO_7	42 / 43	B8	Digital Output_7
DO_8	44 / 43	B9	Digital Output_8



### 2-2-4 Diagnostic LEDs

Referring to the image inserted at the previous page a description of the LEDs functions is given in the table below.

LED	Colour	Action (note 1)	Description
<b>RS</b>	Yellow	ON	RS input active (RUN program)
<b>ERR</b>	Red	Flickering (10Hz)	Checksum error in RETAIN data
		Single flash	CRC error in the configuration file, reset to default
		Double flash	Problem during file system mount
		Triple flash	Checksum VAR % RETAIN error (NOTE 2)
<b>RUN</b>	Green	ON	1131 program running
		OFF	1131 program stopped or not present
<b>PWR</b>	Green	ON	Power Supply present
<b>BAT</b>	Yellow	ON	Backup battery low

**Note:** The ERR LED flashing sequence has a specific meaning which needs to be acknowledged by the user as described on the dedicated MP-02 User manual.

Sequence	Meaning
<b>Blinking</b>	The LED blinks at a frequency of 2.5 Hz (slow)
<b>Flickering</b>	The LED blinks at a frequency of 10 Hz (fast)
<b>Single flash</b>	The LED lites once for at least 200 ms
<b>Double flash</b>	The LED lites twice with pulses of 200 ms each
<b>Triple flash</b>	The LED lites three with pulses of 200 ms each



### 3-1 Electric safety and electromagnetic compatibility

---

Class II instrument, rear panel mounting.

This instrument has been designed in compliance with:

- Regulations on electrical equipment:
  - according to regulations on the essential protection requirements in electrical equipment EN 61010-1
- Regulations on Electromagnetic Compatibility according to:
  - Regulations on RF emissions:  
EN61000-6-4 industrial environments;
  - Regulation on RF immunity:  
EN61000-6-2 industrial equipment and system.

It is important to understand that it's responsibility of the installer to ensure the compliance of the regulations on safety requirements and EMC.

This controller has no user serviceable parts and requires special equipments and specialised engineers to be repaired. For this purpose, the manufacturer provides technical assistance and the repair service for its Customers. Please, contact your nearest Agent for further information.

All the information and warnings about safety and electromagnetic compatibility are marked with the  sign, at the side of the note.

#### 3-1-1 How to increase the electromagnetic immunity



For maximum immunity to disturbance use FIL00014 filter. Install it between the outlet and the power supply, closest to 24 V power supply.

A good ground connection is required between the filter case and the earth.



In addition a FIL00013 clamp filter should be placed on the analogue inputs, outputs and communication cables positioned close to the device winding a loop of the cable in the clamp filter as illustrated.

## 3-2 Installation Precautions and Notes

### 3-2-1 CE Installation Precautions



All wirings must comply with the local regulations;

- The supply wiring should be routed away from the power cables;
- Avoid to use electromagnetic contactors, power relays and high power motors nearby;
- Avoid power units nearby, especially if controlled in phase angle;
- Keep the low level sensor input wires away from the power lines and the output cables. If this is not achievable, use shielded cables on the sensor input, with the shield connected to earth.

### 3-2-2 Installation Notes

- Make sure that the power supply voltage is the same indicated on the instrument label.
- Switch ON the power supply only after all the electrical connections have been completed.

## 3-3 Power Supply Connections

### 3-3-1 P04 Power Supply

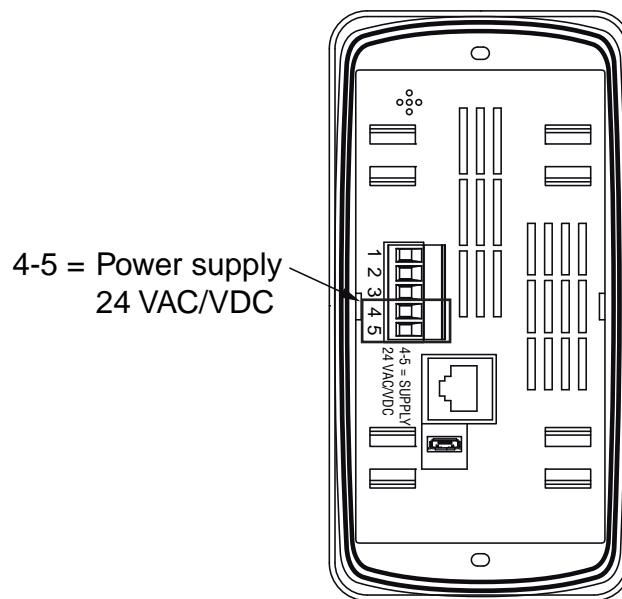

The power supply is to be provided to the operator panel via terminals 4 and 5 of the terminal block. Since the power required can be both in alternate and in direct current (AC/DC), the polarization of the terminals is irrelevant. The power supply terminals are fully isolated from the communication connectors.

### 3-3-2 MP-02 Power Supply

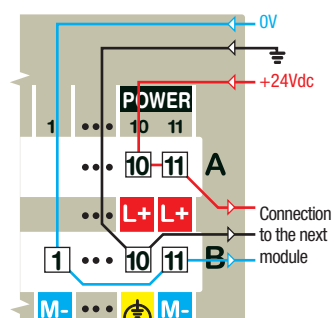

- 24Vdc (-15...+25%), 5W max.;
- The power supply terminals A10 - A11 and B1 - B11 are internally connected; using these terminals it is possible to bring the power supply to other modules.



Functional earth terminal. This type of earthing does not protect against electrical shocks.

Additional Terminal Block TB-211-1

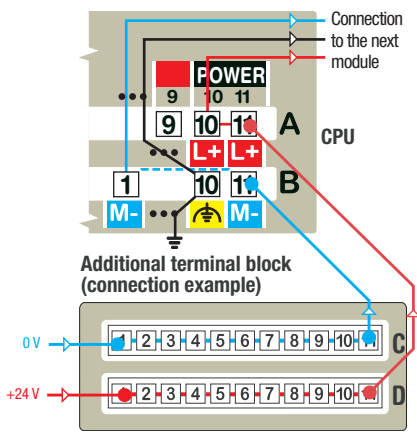

- An additional terminal block can be installed on the CPU module using the two slides located in the lower part of the module case;
- The additional terminal block has no active components inside, only two 11 pitch 5.0mm contacts connectors;
- All the 11 contacts of each connector (C and D) are internally connected and can be used to make multiple connections (see the example).

3-4 Analogue Input Connections

3-4-1 2-3 Wires WTransmitters Input

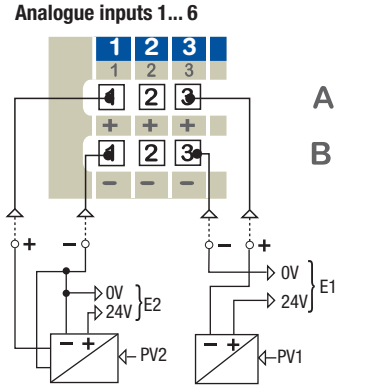

- Both two and three wires transmitters must be powered with an external power supply. To maintain the isolation between the 2 inputs, use 2 distinct power supply sources (E1 - E2);
- If isolation is not required the transmitter can be powered through the module power line.

3-4-2 Voltage Input

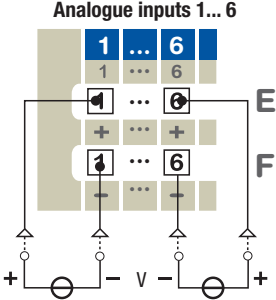

- Respect the polarity shown.

3-4-3 mA Input

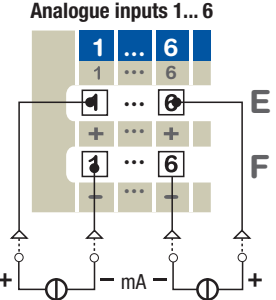

- Respect the polarity shown.

### 3-4-4 J, K, L, N, R, S, T thermocouple type input (with AI-UI opt.)

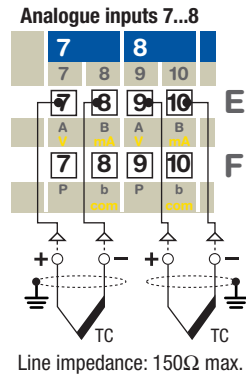

- Respect the polarity shown;
- To extend the connection, use always compensation cable of the correct type for the thermocouple used;
- When present, the shield must be connected to a proper earth (at only one end).

### 3-4-5 Pt100, Pt1000 (2, 3, 4 wires) input (with AI-UI opt.)

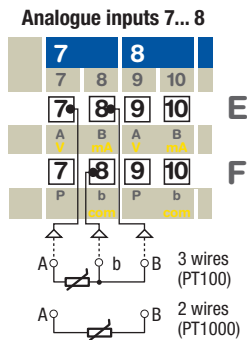

- The connection example refers only to input 7, for input 8 copy the same connection configuration;
- When 3 wires system is used, always use cables of the same section (1mm<sup>2</sup> min.)(max. resistance 20Ω/line);
- When 2 wires system is used and the distance between the module and the sensor is 15 m, the use of a 1.5 mm<sup>2</sup> section cable produces a 1°C (1.8°F) measure error.

### 3-4-6 mV input (with AI-UI opt.)

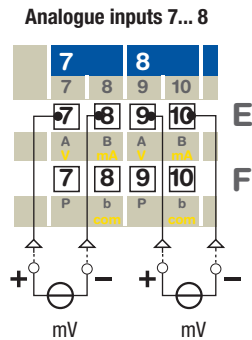

### 3-4-7 Potentiometer input (with AI-UI opt.)

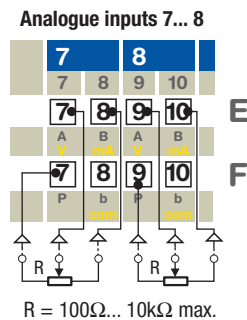

### 3-4-8 High level inputs (with AI-HL opt.)

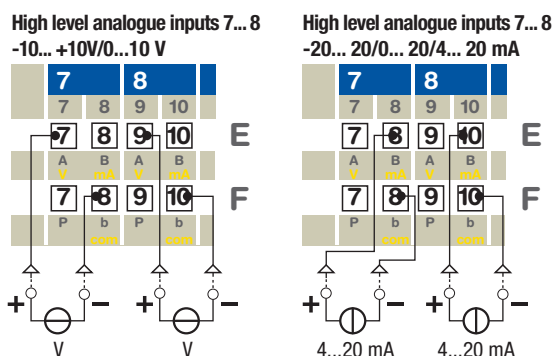

## 3-5 Digital Input Connections

### 3-5-1 Digital Inputs 1...8 Type II (EN61131-2)

Contact Input

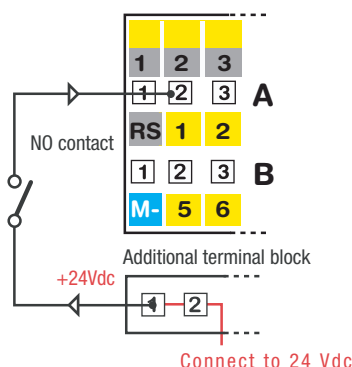

- Respect the polarity;
- When present the shield must be connected to a proper earth (at only one end).

### 3-5-2 Digital Inputs 1...8 Type II (EN61131-2)

Source (PNP) device

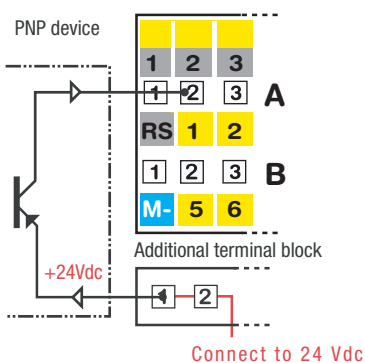

- Respect the polarity.
- When present the shield must be connected to a proper earth (at only one end);
- If the input device needs to be powered by the module, verify that the current consumption does not exceed the power supply limits.

## 3-6 Analogue Output Connections

### 3-6-1 Analogue outputs 1... 4 (opt.)

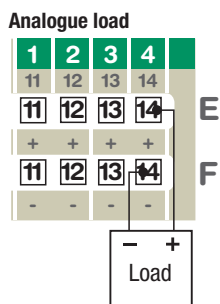

- The user can choose the number of analogue output installed in the central unit (0, 2 or 4 outputs);
- Respect the polarity.

## 3-7 Digital Output Connections

### 3-7-1 Digital Output 1...8 (PNP) Source Type

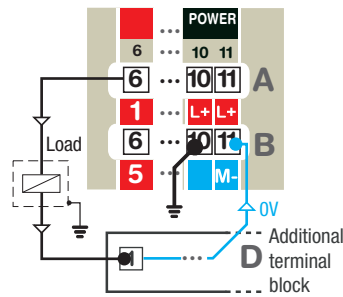

- 24 Vdc, 0.5A digital outputs;
- Respect the polarity;
- When present the shield must be connected to a proper earth (at only one end).

## 3-8 Communications connections

On the CPU module are present all the communications ports. Connect the cable of the various interfaces as follows.

### 3-8-1 X0 port RS232/485 Service/Modbus Port connector

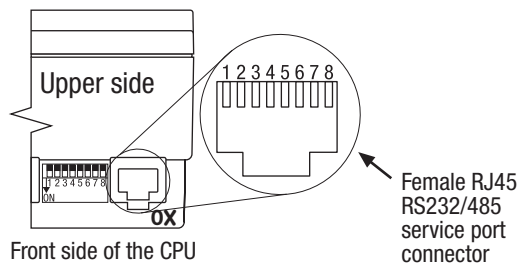

The RS232 Service Port can be used to configure the CPU and its devices using a dumb VT100 terminal. The RJ45 RS232/485 Service Port connector is located in the upper side (on the right) of the CPU (see “2-2-2 MP-02 CPU” on page 15). Looking the hole of the plug the 8 contacts are arranged as illustrated in the draw.

- Service Port connection**
1. The RS232 cable must be shorter than 15 m.
  2. The hardware default configuration of the Service Port is:
    - Baud Rate: 9600 bps;
    - Data: 8 bit;
    - Stop bit: 1;
    - Parity: none;
    - Flow Control: none.

**Note:** Consult the “MP-02 User Manual” for details about the service port configuration.

**Service Port signals** The signals present at the RJ45 connector of the Service Port are:

Pin	Signal
1	D+ (RS485)
2	D- (RS485)
3	GND (RS485)
4	GND (RS232)
5	RX (RS232)
6	TX (RS232)
7	NC
8	NC



### 3-8-2 X1 Port RS485 Modbus Port connector

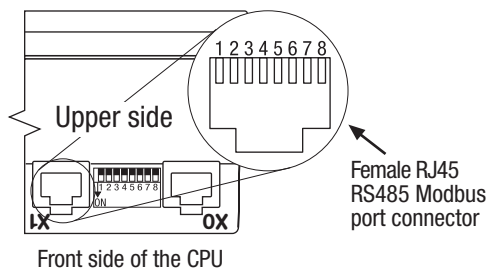

The RS485 Modbus Port can be used to connect a Modbus fieldbus. The RJ45 RS485 Modbus Port connector is located in the upper side (on the left) of the CPU (see “2-2-2 MP-02 CPU” on page 15). Looking the hole of the plug the 8 contacts are arranged as illustrated in the draw.

- RS485 Modbus Port Connection**
1. The RS232 cable must be shorter than 15 m.
  2. The default configuration of the Service Port is:
    - Baud Rate: 9600 bps;
    - Data: 8 bit;
    - Stop bit: 1;
    - Parity: none;
    - Flow Control: none.

**Note:** The selection of DIP switches 4 and 5 must match the selection operated by the configuration section (consult the “MP-01 User Manual”).

**RS485 Modbus Port signals** The signals present at the RJ45 connector of the Modbus Port are:

Pin	Signal
1	D+ (RS485)
2	D- (RS485)
3	GND (RS485)
4	NC
5	NC
6	NC
7	NC
8	NC

**X0/X1 Ports DIP Switches** The Communications Ports electrical settings can be selected through the microswitches located between the Serial Port connectors.

The following table describes the selectable options.

Aspect	Switch	Port	Description	ON	OFF	Default
	1	X1	Termination Resistance (110Ω)	Enabled	Disabled	OFF
	2	X1	Pull-Down Line polarization	Enabled	Disabled	OFF
	3	X1	Pull-Up Line polarization	Enabled	Disabled	OFF
	4	X0	RS232 Selection	Enabled	Disabled	ON
	5	X0	RS485 Selection	RS485	RS232	OFF
	6	X0	Termination Resistance (110Ω)	Enabled	Disabled	OFF
	7	X0	Pull-Down Line polarization	Enabled	Disabled	OFF
	8	X0	Pull-Up Line polarization	Enabled	Disabled	OFF

### 3-8-3 LAN - Ethernet TCP/IP port connector

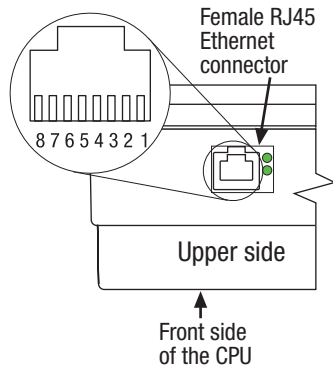

The Ethernet TCP/IP port RJ45 connector is located in the upper side of the CPU (see “2-2-2 MP-02 CPU” on page 15). Looking the hole of the plug the 8 contacts are arranged as illustrated in the draw.

*Ethernet signals* The signals present on the RJ45 ethernet connector are those standard for all Ethernet TCP/IP connection.

To connect correctly the CPU to the programming computer, use an ethernet “cross cable” in case of direct connection (no HUB or network router between the PC and the CPU); otherwise, if the Computer is not directly connected to the CPU, use a “patch cable” to connect the CPU.

Pin	Signal
1	TX+
2	TX-
3	RX+
4	NC
5	NC
6	RX-
7	NC
8	NC

## Chapter 4

# Replacing the RTC Battery

---

- With the blade of a screwdriver, free the 8 slots (at the top and bottom of the CPU) in order to remove the rear cover from the rest of the the housing;

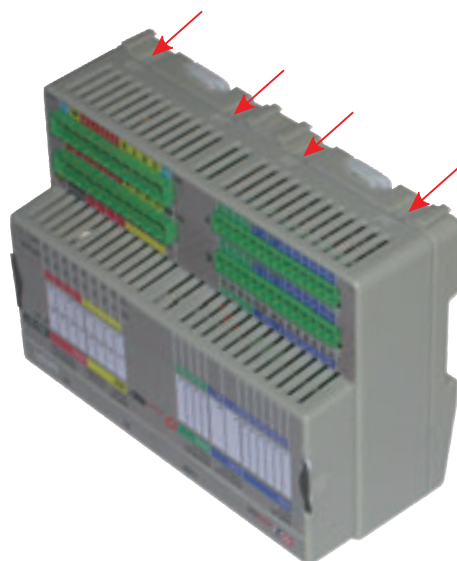
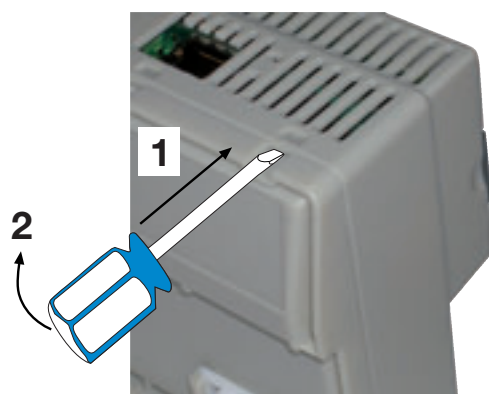

### WARNING

The procedure to replace the RTC battery must be done with the 24Vdc power supply **CONNECTED** (the MP-01 Powered **ON**).

---

- Once the box of the CPU is open, locate the battery position and slide it out from the terminals (see image);



- Replace the battery with the positive pole facing the rear panel of the CPU and the negative one in contact with the printed circuit (see image). Pay attention not to touch the battery with the fingers;

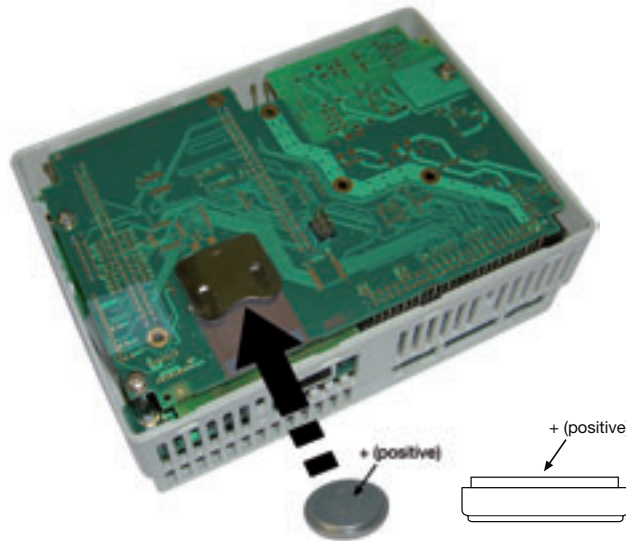

- After the battery has been changed, the user can close the CPU rear cover:
  1. The rear cover must be positioned in order to put the two slides which lock the box to the DIN rail in the lower part (look at the CPU front to identify the upper and lower CPU side).
  2. After the two parts of the CPU have been aligned, press the two parts of the box in order to re-insert the 8 slots opened at the beginning of this setting procedure.

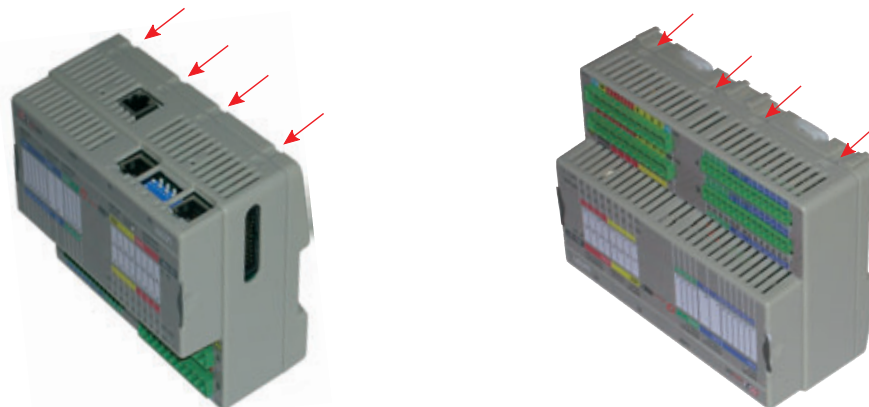

# Appendix A

## Accessories

---

### A-1 Connection accessories

---

#### A-1-1 11 poles connectors

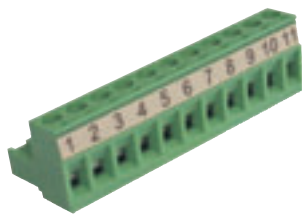

With screw terminals: AP-S2/SPINA-V11

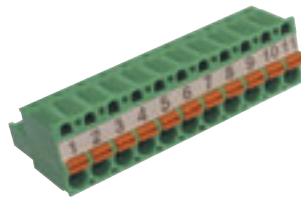

With spring terminals: AP-S2/SPINA-M11

#### A-1-2 14 poles connectors

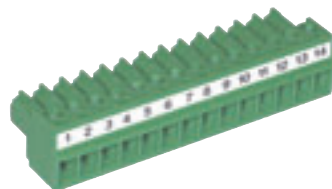

With screw terminals: AP-S2/SPINA-V14

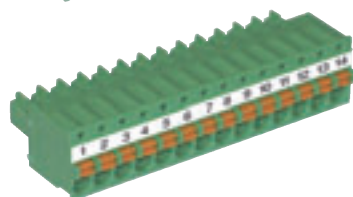

With spring terminals: AP-S2/SPINA-M14

#### A-1-3 Additional terminal block



AP-S2/TB-211-1

## A-2 Power Supply

---

### A-2-1 Power supply 75W - 3A/24Vdc

APS2ALDR75-24



### A-2-2 Power supply 120W - 5A/24Vdc

APS2ALDR12024



## A-3 Disturbance Protection Accesories

---

### A-3-1 EMC Filter

FIL00014



### A-3-2 EMC Clamp filter

FIL00013



---

## A-4 Network Connection Accesories

---

### A-4-1 Ethernet Switch

APS2ATOPEH2006



### A-4-2 RS485 Splitter

RS485 splitter with RJ45 connectors:  
APS2LOCALBUSDUPLX





Ascon TecnoLogic Srl  
Via Indipendenza, 56  
27029 Vigevano (PV) Italia

Tel. +39/0381/69871  
Fax +39/0381/698730

[info@ascontecnologic.com](mailto:info@ascontecnologic.com)

All rights reserved. No parts of this publication may be reproduced, in any form, without Ascon TecnoLogic S.r.l. written permission.

Every care has been taken preparing this manual; the document has been carefully reviewed for technical accuracy. In the event that technical or typographical errors exist Ascon TecnoLogic S.r.l. reserves the right to make changes without any notice.

In no event shall Ascon TecnoLogic S.r.l. be liable for any damages arising out of or related to this document or the information contained in it.

If errors are suspected, please contact Ascon TecnoLogic S.r.l. at the above address.