

# YASKAWA AC Drive

## F7 to A1000

### Product Transition Guide

Type: CIMR-F7U

Models: 240 V Class, Three-Phase Input: 1/2 to 150 HP Heavy Duty\*  
1/2 to 175 HP Normal Duty  
480 V Class, Three-Phase Input: 1/2 to 500 HP Heavy Duty\*  
1/2 to 600 HP Normal Duty

Type: CIMR-AU

Models: 240 V Class, Three-Phase Input: 3/4 to 150 HP Heavy Duty\*  
3/4 to 175 HP Normal Duty  
480 V Class, Three-Phase Input: 3/4 to 900 HP Heavy Duty\*  
3/4 to 1000 HP Normal Duty

\* Note: This guide lists only comparable models. Refer to the product catalog for a list of all available models.  
The Heavy Duty drive ratings (HD) are primarily used in this guide to facilitate data comparison.

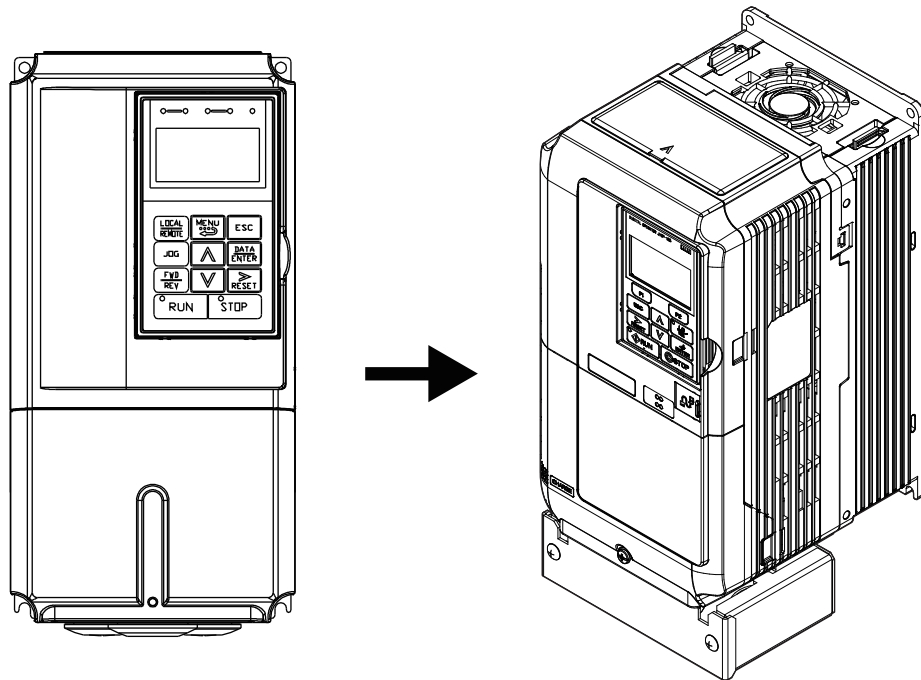





# Replacing F7 with A1000

---

1	FEATURE OVERVIEW .....	4
2	F7 TO A1000 FEATURE SPECIFICATIONS .....	5
3	DIGITAL OPERATOR COMPARISON .....	6
4	FRONT COVER & COOLING FAN COMPARISON .....	7
5	NAMEPLATE/LABELING DIFFERENCES .....	8
6	MAIN CONTROL PCB COMPARISON .....	9
7	A1000 DRIVE OPTIONS .....	15
8	DETAILS ON NEW A1000 FEATURES AND FUNCTIONS .....	16
9	APPENDIX 1 RATINGS .....	20
10	APPENDIX 2 PARAMETER CROSS REFERENCE .....	30
11	APPENDIX 3 TERMINAL SIZE AND WIRE GAUGE .....	56

# 1 Feature Overview

This document details differences between the F7 and A1000 product to assist in product transition and new product introductions.

F7 Drive	A1000 Drive
	
<p>The F7 drive is primarily used for general purpose industrial applications.</p>	<p>The A1000 drive is primarily used for general purpose and high performance industrial applications, including those that require precise torque and speed control as well as control of both induction and permanent magnet motors.</p>

**Table 1 Key A1000 Features and Functions**

Key A1000 Features and Functions	Key A1000 Features and Functions
<ul style="list-style-type: none"> <li>• Closed or open loop vector control for outstanding regulation, torque production, and position control capability</li> </ul>	<ul style="list-style-type: none"> <li>• Auxiliary Control Power Unit maximizes production time and efficiency by maintaining network communication while main power is removed</li> </ul>
<ul style="list-style-type: none"> <li>• Continuous Auto-tuning optimizes performance by compensating for changes in motor temperature</li> </ul>	<ul style="list-style-type: none"> <li>• Embedded Safe Torque Off minimizes downtime for applications requiring occasional intervention (SIL CL2, PLd, Category 3)</li> </ul>
<ul style="list-style-type: none"> <li>• High Frequency Injection enables high precision open loop control of Interior Permanent Magnet Motors</li> </ul>	<ul style="list-style-type: none"> <li>• Embedded function blocks, programmable with DriveWorksEZ, provide additional application flexibility and the opportunity to eliminate separate controllers</li> </ul>
<ul style="list-style-type: none"> <li>• Fast acting current and voltage limiters help achieve continuous drive operation during periods of excessive demand</li> </ul>	<ul style="list-style-type: none"> <li>• USB Copy Unit and Keypad configuration storage provide speed and convenience for duplicate configuration of multiple drives</li> </ul>
<ul style="list-style-type: none"> <li>• High Slip Braking reduces installation cost and the need for dynamic braking resistors</li> </ul>	<ul style="list-style-type: none"> <li>• Removable terminal board with configuration storage provides convenience of configuration backup</li> </ul>
<ul style="list-style-type: none"> <li>• Communication options for all major industrial networks provides high speed control and monitoring, reducing installation cost</li> </ul>	<ul style="list-style-type: none"> <li>• Made with RoHS compliant materials</li> </ul>
<ul style="list-style-type: none"> <li>• DriveWizard computer software and Application Sets for easy configuration</li> </ul>	<ul style="list-style-type: none"> <li>• Integrated DC Reactor (standard on 30 HP and larger) for input harmonic reduction</li> </ul>

## 2 F7 to A1000 Feature Specifications

Table 2 Feature Specifications

Feature	Item	Yaskawa F7	Yaskawa A1000
HP Range	200 V	240V 0.5 to 150 HP (HD) 0.5 to 175 HP (ND) <I>	240 V 0.75 to 150 HP (HD) 0.75 to 175 HP (ND)
	400 V	480V 0.5 to 500 HP (HD) 0.5 to 600 HP (ND)	480 V 0.75 to 900 HP (HD) 0.75 to 1000 HP (ND)
	600 V	—	600 V 2 to 250 HP (ND)
Input Voltage	Rated Voltage	3-phase, 200-240 Vac 3-phase, 380-480 Vac	3-phase, 200-240 Vac 3-phase, 380-480 Vac 3-phase, 500-600 Vac
Motor types	—	Induction	Induction, Permanent Magnet
PWM Carrier Frequency	Range	See Appendix 1	See Appendix 1
Maximum Output Frequency	Hz	300 Hz (HD) 400 Hz (ND) 1000 Hz optional	400 Hz (1000 Hz optional)
Keypad Design	Display	5 Line X 16 Character LCD	5 Line X 16 Character LCD
	Copy Function	Yes	Yes
Digital Input Terminal	NPN/PNP	Switchable NPN/PNP	Switchable NPN/PNP
Digital output Terminal	Open Collector	0	0
	Relay Output	3 x Form A, 1 x Form C	3 x Form A, 1 x Form C
Analog Output	Output Level	2 channels with independent level selections 0-10 V (10 bit plus sign) or -10-+10 V or 10 bit plus sign or 4-20 ma 10 bit	2 channels with independent level selections 0-10 V (10 bit plus sign) or -10-+10 V or 10 bit plus sign or 4-20 ma 10 bit
Pulse Input	Qty:	1	1
	Input Frequency	1-32 kHz	1-32 kHz
Pulse Output	Qty:	1	1
	Output Frequency	1-32 kHz	1-32 kHz
Quick Disconnect Terminals	Type	Yes	Yes
Auto Tuning	Methods	Rotating, Stationary	Rotating, Stationary, Continuous, Inertia /ASR
Preset Speeds	Qty.	17	17
Speed Search	Bi/Uni-Directional	Bi-Directional	Bi-Directional
	Method	Current/Speed	Current/Speed Estimation
Auto Restart	Time Between Attempts	0.0 – 5.0 sec (selectable)	0.0 – 5.0 sec (selectable)
Energy Savings Mode	Man/Auto	Man/Auto	Man/Auto
DC Injection Function	At Start/At Stop	At Start/At Stop +HSB during stop	At Start/At Stop +HSB during stop
Braking Function	DB Transistor	Built-in to 25 HP	Built-in to 40 HP (HD)
	Special	High Slip Braking	High Slip/Over-excitation Braking
Cooling Fan On/Off Control	Power/Run	Run Based	Selectable Always Active/During Run
Timer Function	On/Off Delay	On/Off Delay (0-3000 s)	On/Off Delay (0-3000 s)
Fault Code Additions	—	10 additional	10 with elapsed time stamp
Torque Limit/Current Limit/ Stall Prevention	—	Stall Prevention During Accel/Run/Decel (V/F) Torque Limit in 4 Quadrants (Vector) Software Current Limit (HD=150 %, ND=120 %)	Stall Prevention During Accel/Run/Decel (V/F) Torque Limit in 4 Quadrants (Vector) Software Current Limit (HD=150 %, ND=120 %)
Harmonic Counter Measures	—	12 Pulse: 30 HP and Above Filters/Reactors (Options)	Filters/Reactors (Options)
	Built-In DC Bus Reactor	240 Vac: 30-150 HP (HD) 480 Vac: 30-500 HP (HD)	240 Vac: 30-175 HP (ND) 480 Vac: 30-1000 HP (ND) 600 Vac: 30-250 HP (ND)
Ambient Temperature	°C	-10°C ~ +40°C (IP21) -10°C ~ +45°C (IP00)	-10 to +50°C (Open Chassis Installation) -10 to +40°C (Chassis with zero side clearance, or Type 1)
Storage Temperature	°C	-20°C ~ +60°C	-20°C ~ +60°C
Network Communications	Standard	Modbus RTU via terminal I/O RS485/422	Modbus RTU via terminal I/O RS485/422
	Optional	DeviceNet, Profibus-DP, ControlNet, Ethernet	DeviceNet, Profibus-DP, ProfiNet, Ethernet, Modbus TCP/IP, Mechatrolink
Unique Feature/Function	—	HSB – High Slip Braking	Over-excitation Braking

&lt;I&gt; HD = Heavy Duty, ND = Normal Duty

### 3 Digital Operator Comparison

- Enhanced LCD operator with built-in copy function and parameter verify for A1000
- Soft Keys simplify operation and programming
- Optional LED operator available for A1000
- LCD contrast adjustment
- Simplified parameter grouping for easier navigation and set-up
- The A1000 has a new layout for faster parameter selection

**Table 3 Digital Operator**

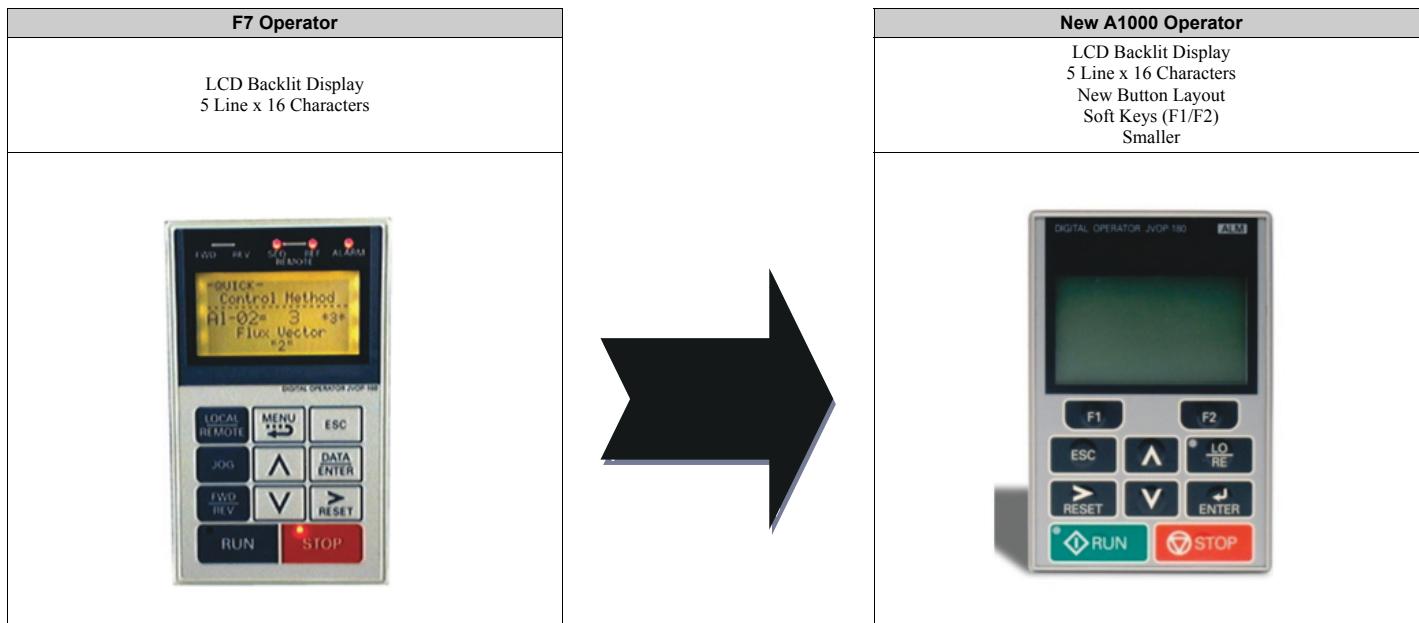

- A1000 copy keypad is capable of uploading all of the parameter settings from the A1000 drive memory.
  - Upload of F7 parameters to the A1000 is not available.
  - A1000 drives must have the same software version, model, and control mode to copy parameters between A1000 drives.
- A Quick Start menu is added to aid in simple start up.
- The Quick Start menu consists of 26 parameters. The advanced menu offers full parameter access.
- There is a new button layout for quicker drive navigation.

**Table 4 Menu Structure Comparison**

F7	A1000
Operation "DRIVE"	Operation
Quick Setting "QUICK"	Auto-Tuning
Programming "ADV"	Programming
Modified Constants "VERIFY"	Quick Settings
Auto-Tuning "A.TUNE"	Modified Constants
—	Monitor Menu

## 4 Front Cover & Cooling Fan Comparison

**F7 - Split Front Cover**



**A1000 - Split Front Cover**

The A1000 is provided with a split cover to allow terminal only access. The split cover limits exposure to the control PCB and power structure during wiring.



**F7 Modular Cooling**

























**A1000 - New Modular Top-Mounted Cooling Fan**

- The A1000 features an easy to remove top mounted heat sink fan.
- Fan operation is parameter controlled.
- Fan operation time can be monitored for preventative maintenance.



# 5 Nameplate/Labeling Differences

Table 5 Nameplates and Front Labels

F7 Side Nameplate	A1000 Side Nameplate																																						
<div style="border: 1px solid black; padding: 5px;"> <table border="1"> <tr> <td>MODEL: CIMR-F7U20P4</td> <td>SPEC: 20P41E</td> </tr> <tr> <td>INPUT: AC3PH 200-240V 50/60Hz</td> <td>HD:3.8A ND:4.3A</td> </tr> <tr> <td>OUTPUT: AC3PH 0-240V 0-400Hz</td> <td>HD:3.2A 1.2kVA ND:3.6A 1.4kVA</td> </tr> <tr> <td>O/N:</td> <td>MASS: 3.0kg</td> </tr> <tr> <td>S/N:</td> <td>PRG:</td> </tr> <tr> <td colspan="2" style="text-align: center;">  </td> </tr> <tr> <td>FILE NO: E131457</td> <td>TYPE 1 ENCLOSURE IP20</td> </tr> </table> </div>	MODEL: CIMR-F7U20P4	SPEC: 20P41E	INPUT: AC3PH 200-240V 50/60Hz	HD:3.8A ND:4.3A	OUTPUT: AC3PH 0-240V 0-400Hz	HD:3.2A 1.2kVA ND:3.6A 1.4kVA	O/N:	MASS: 3.0kg	S/N:	PRG:			FILE NO: E131457	TYPE 1 ENCLOSURE IP20	<div style="border: 1px solid black; padding: 5px;"> <table border="1"> <tr> <td>MODEL : CIMR-AU2A0021FAA</td> <td>REV : A</td> </tr> <tr> <td>C/C CIMR-AU2A0021FAA</td> <td></td> </tr> <tr> <td>INPUT : AC3PH 200-240V 50/60Hz 24A/18.9A</td> <td></td> </tr> <tr> <td>OUTPUT : AC3PH 0-240V 0-400Hz 21A/17.5A</td> <td></td> </tr> <tr> <td>MASS : 3.7 kg</td> <td>PRG : 1010</td> </tr> <tr> <td>O / N :</td> <td></td> </tr> <tr> <td>S / N :</td> <td></td> </tr> <tr> <td colspan="2" style="text-align: center;">  </td> </tr> <tr> <td>FILE NO : E131457</td> <td>IP20</td> </tr> <tr> <td>TYPE 1 ENCLOSURE</td> <td style="text-align: right;">PASS</td> </tr> <tr> <td colspan="2" style="text-align: center;">     </td> </tr> <tr> <td colspan="2" style="text-align: center;">  Assembled in USA </td> </tr> </table> </div>	MODEL : CIMR-AU2A0021FAA	REV : A	C/C CIMR-AU2A0021FAA		INPUT : AC3PH 200-240V 50/60Hz 24A/18.9A		OUTPUT : AC3PH 0-240V 0-400Hz 21A/17.5A		MASS : 3.7 kg	PRG : 1010	O / N :		S / N :				FILE NO : E131457	IP20	TYPE 1 ENCLOSURE	PASS	   		 Assembled in USA	
MODEL: CIMR-F7U20P4	SPEC: 20P41E																																						
INPUT: AC3PH 200-240V 50/60Hz	HD:3.8A ND:4.3A																																						
OUTPUT: AC3PH 0-240V 0-400Hz	HD:3.2A 1.2kVA ND:3.6A 1.4kVA																																						
O/N:	MASS: 3.0kg																																						
S/N:	PRG:																																						
																																							
FILE NO: E131457	TYPE 1 ENCLOSURE IP20																																						
MODEL : CIMR-AU2A0021FAA	REV : A																																						
C/C CIMR-AU2A0021FAA																																							
INPUT : AC3PH 200-240V 50/60Hz 24A/18.9A																																							
OUTPUT : AC3PH 0-240V 0-400Hz 21A/17.5A																																							
MASS : 3.7 kg	PRG : 1010																																						
O / N :																																							
S / N :																																							
																																							
FILE NO : E131457	IP20																																						
TYPE 1 ENCLOSURE	PASS																																						
   																																							
 Assembled in USA																																							
F7 Front Label	A1000 Front Label																																						
																																							



# 6 Main Control PCB Comparison

F7 Control PCB



New A1000 Control PCB



A1000 Removable Terminal Board

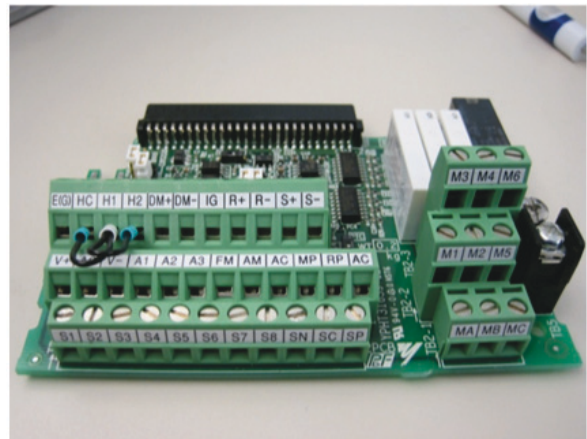

◆ Terminal Board Set-Up Comparison

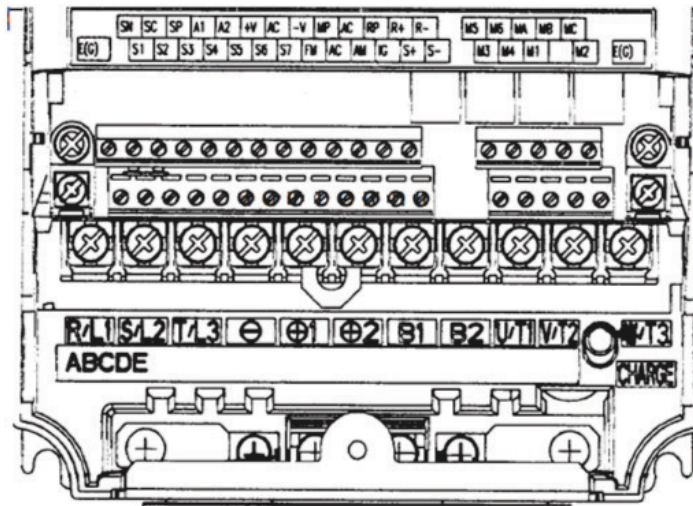

Figure 1 F7 Terminal Board Configuration

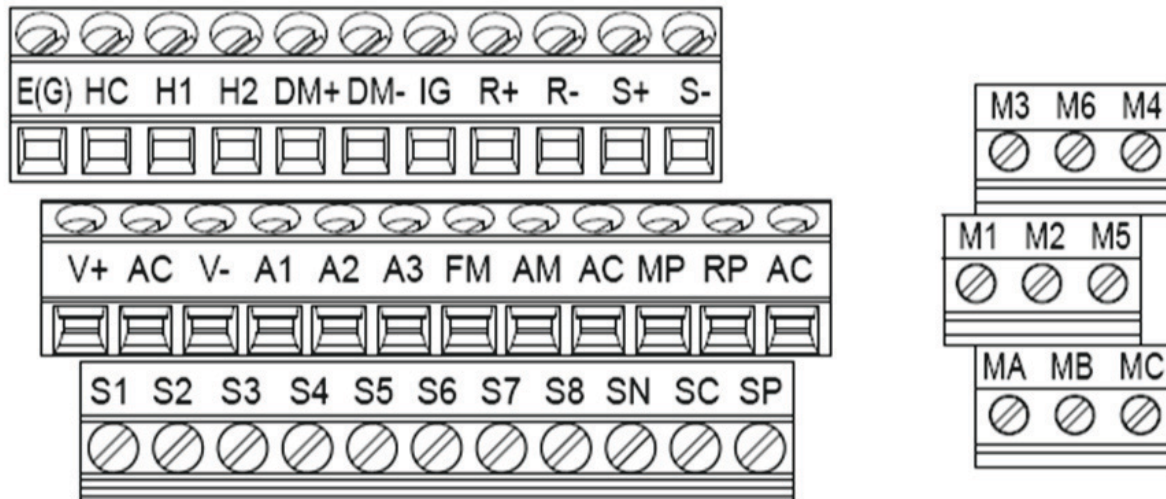

Figure 2 A1000 Terminal Board Configuration

◆ F7 to A1000 Terminal Comparison

Table 6 Factory Default Terminal Functions 2-Wire Control

F7 Terminal			A1000 Terminal (Designations similar to F7)		
Type	F7 Terminal	Default Function	A1000 Terminal	Default Function	A1000 Description
Digital Input Signals	S1	Forward run/stop command	S1	Forward run/stop	Multi-function inputs 1-8  Photocoupler 24 Vdc, 8 mA Set the S3 jumper to select between sinking, sourcing mode, and the power supply.
	S2	Reverse run/stop command	S2	Reverse run/stop	
	S3	External fault input	S3	External fault, N.O.	
	S4	Fault reset	S4	Fault reset	
	S5	Multi-step speed reference 1 (Master/auxiliary switch)	S5	Multi-step speed reference 1	
	S6	Multi-step speed reference 2	S6	Multi-step speed reference 2	
	S7	Jog frequency reference	S7	Jog reference	
	S8	External baseblock N.O.	S8	External baseblock	
	SC	Factory connected to SP	SC	Multi-function input common	—
	SN	Digital input common	SN	Digital input power supply 0 V	24 Vdc power supply for digital inputs, 150 mA max (only when not using digital input option DI-A3)
SP	Factory connected to SC	SP	Digital input power supply +24 Vdc		
Safe Disable Inputs	—	—	H1	Safe Disable input 1	<ul style="list-style-type: none"> <li>• 24 Vdc, 8mA</li> <li>• One or both open: Output disabled</li> <li>• Both closed: Normal operation</li> <li>• Internal impedance: 3.3 kΩ</li> <li>• Of time of at least 1 ms</li> </ul> Disconnect the wire jumpers shorting terminals H1, H2, and HC to use the Safe Disable inputs. Set the S5 jumper to select between sinking, sourcing mode, and the power supply.
	—	—	H2	Safe Disable input 2	
	—	—	HC	Safe Disable function common	
Analog Input Signals	RP	Pulse input	RP	Multi-function pulse train input (frequency reference)	Input frequency range: 0 to 32 kHz Signal Duty Cycle: 30 to 70 % High level: 3.5 to 13.2 Vdc, low level: 0.0 to 0.8 Vdc Input impedance: 3 kΩ
	+V	+15 Vdc power output	+V	Power supply for analog inputs	10.5 Vdc (max allowable current 20 mA)
	-V	-15 Vdc power output	-V	Power supply for analog inputs	-10.5 Vdc (max allowable current 20 mA)
	A1	Analog input or speed command	A1	Multi-function analog input 1 (Frequency reference bias)	-10 to 10 Vdc, 0 to 10 Vdc (input impedance: 20 kΩ)
	A2	Add to terminal A1	A2	Multi-function analog input 2 (Frequency reference bias)	-10 to 10 Vdc, 0 to 10 Vdc (input impedance: 20 kΩ) 4 to 20 mA, 0 to 20 mA (input impedance: 250 kΩ) Voltage or current input must be selected by DIP switch S1 and H3-09.
	A3	Aux. frequency reference 1	A3	Multi-function analog input 3 (Auxiliary frequency reference)/PTC input	-10 to 10 Vdc, 0 to 10 Vdc (input impedance: 20 kΩ) Use DIP switch S4 on the terminal board to select between analog and PTC input
	AC	Analog common	AC	Analog frequency reference common	0 V
	E(G)	Shield wire, optional ground line connection point	E(G)	Ground for shielded lines and option cards	—
Digital Output Signals	M1	During run (N.O. contact)	M1	During run (closed at run)	<ul style="list-style-type: none"> <li>• Multi-function digital outputs,</li> <li>• N.O. contacts, 30 Vdc, 10 mA to 1 A</li> <li>• 250 Vac, 10 mA to 1 A</li> <li>• Minimum load: 5 Vdc, 10 mA</li> </ul>
	M2	Zero speed (N.O. contact)	M2	Zero speed (closed at zero speed)	
	M3	Frequency agree (N.O. contact)	M3	Speed Agree 1 (closed at speed agree)	
	M4		M4		
	M5		M5		
	M6		M6		

## 6 Main Control PCB Comparison

F7 Terminal			A1000 Terminal (Designations similar to F7)		
Type	F7 Terminal	Default Function	A1000 Terminal	Default Function	A1000 Description
Fault Relay	MA	Fault output signal (SPDT)	MA	N.O.	30 Vdc, 10 mA to 1 A; 250 Vac, 10 mA to 1 A
	MB		MB	N.C. output	
	MC		MC	Fault output common	
Analog Output Signals	FM	Output frequency	FM	Analog monitor output 1 (Output frequency)	-10 to +10 Vdc, or 0 to +10 Vdc
	AM	Output current	AM	Analog monitor output 2 (Output current)	
	AC	Analog common	AC	Monitor common	0 V
	MP	Pulse monitor	MP	Pulse train output (Output frequency)	32 kHz (max)
RS-485/422	R+	Modbus communication Differential input, PHC isolation	R+	Communications input (+)	MEMOBUS/Modbus communication: Use an RS- 485 or RS-422 cable to connect the drive. RS-485/422 MEMOBUS/ Modbus comm. protocol: 115.2 kbps (max.)
	R-		R-	Communications input (-)	
	S+	Modbus communication Differential output, PHC isolation	S+	Communications output (+)	
	S-		S-	Communications output (-)	
	IG	Signal common	IG	Shield ground	
Safety Monitor Output	—	—	DM+	Safety monitor output	Output status of Safe Disable function Closed when both Safe Disable channels are closed. Open Collector: +48 Vdc 50 mA maximum
	—	—	DM-	Safety monitor output common	

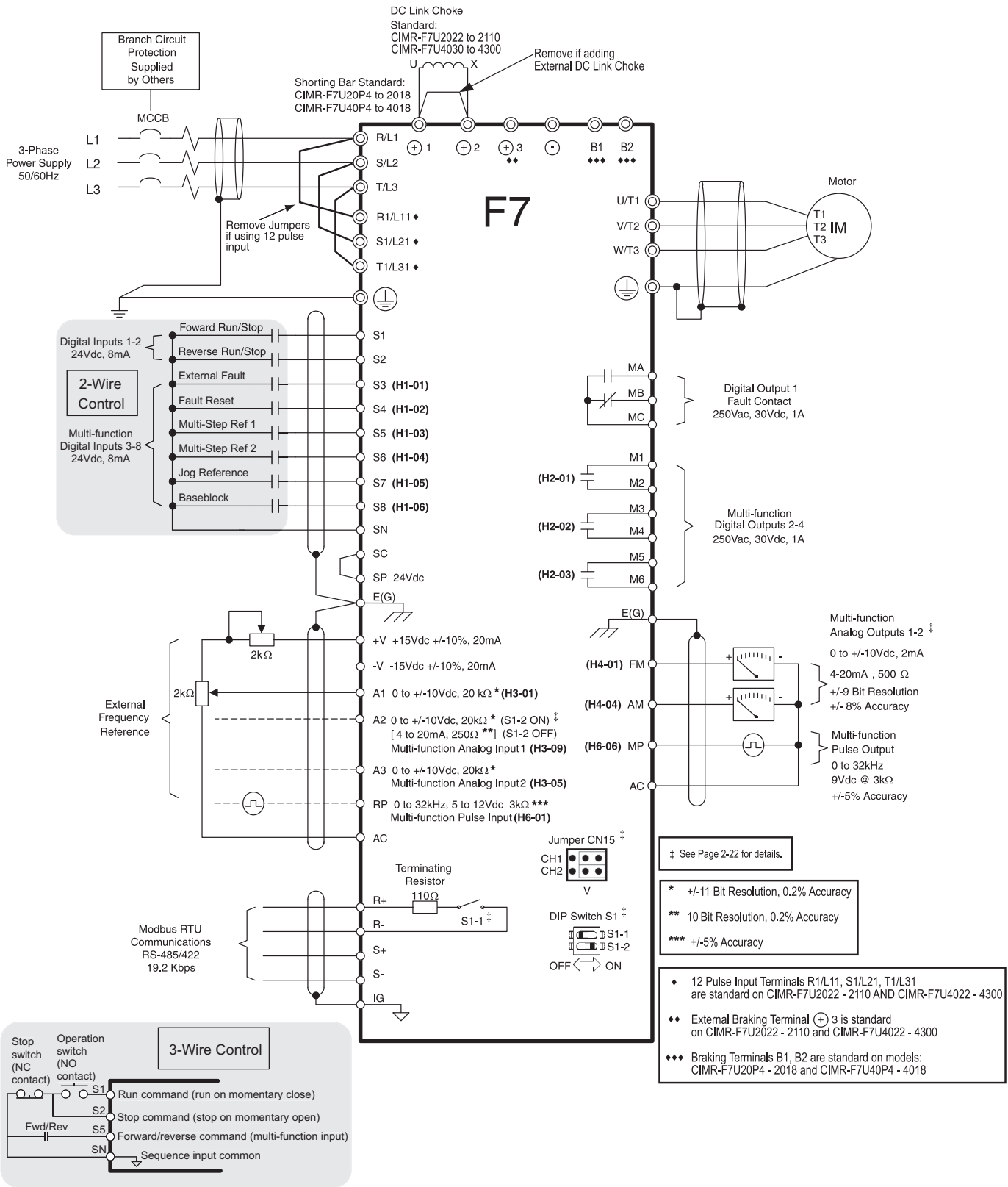

Figure 3 F7 Connection Diagram

# 6 Main Control PCB Comparison

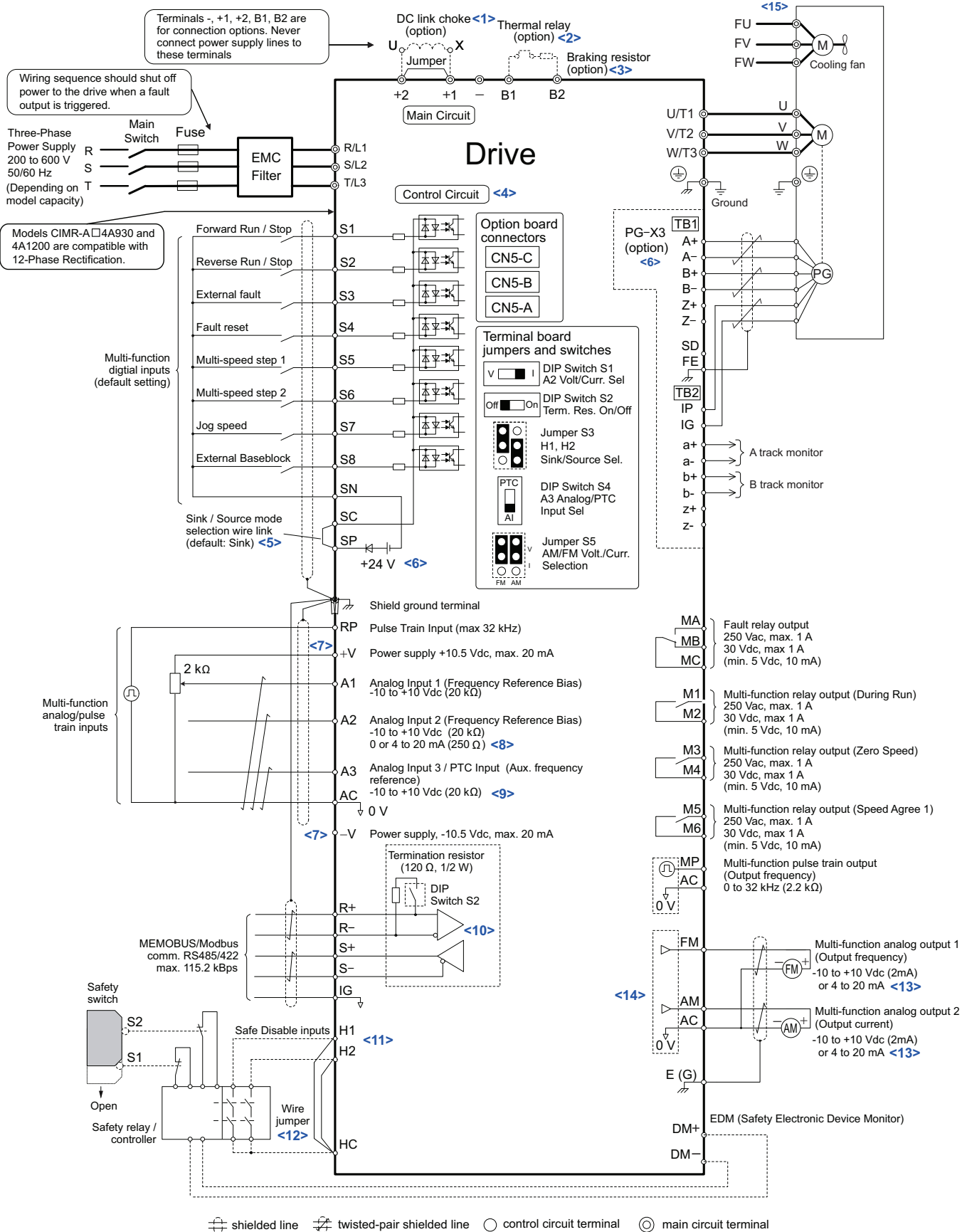

Figure 4 A1000 Connection Diagram

## 7 A1000 Drive Options

Category	Option Name	Model Number
Network Communication	Profibus-DP	SI-P3
	DeviceNet	SI-N3
	Mechatrolink	SI-T3
	EtherNet/IP	SI-EN3
	Modbus TCP/IP	SI-EM3
	ProfiNET	SI-EP3
Motor Feedback	Line Driver PG	PG-X3
	Open Collector PG	PG-B3
	Serial Absolute FB	FG-F3
	Resolver Feedback	PG-RT3
Input/Output	Analog Input	AI-A3
	Analog Output	AO-A3
	Digital Input	DI-A3
	Digital Output	DO-A3
	120 Vac Interface Board	(Contact factory)
Keypad	LCD Keypad	JVOP-180
	LED Keypad	JVOP-182
	Remote Mount Keypad Kit - Blank	UUX000526
	Remote Mount Keypad Kit - YEA	UUX000527
	LCD Operator Extension Cable, 1 m	UWR0051
	LCD Operator Extension Cable, 3 m	UWR0052
Control Power Unit	24 V Control Power Unit	PS-A10H for 480 V and 600 V class
		PS-A10L for 240 V class
Parameter Management	Y-Stick USB Copy Unit	JVOP-181
	Drive Wizard Pro PC Support Tool	DriveWizard Industrial
	PC Support Tool Cable	UWR0638 USB Cable, 10 ft, male A-type to male B-type
DriveWorksEZ	DriveWorksEZ Std	(Contact factory)
	DriveWorksEZ Pro	(Contact factory)



# 8 Details on New A1000 Features and Functions

Note: This section details significant A1000 features.

## ◆ Over-Excitation Braking

This braking method allows for faster stops without the addition of a dynamic braking resistor. While still not as fast or powerful as DB, it offers a very necessary middle ground for those applications that may not require the full power of dynamic braking, saving money in hardware.

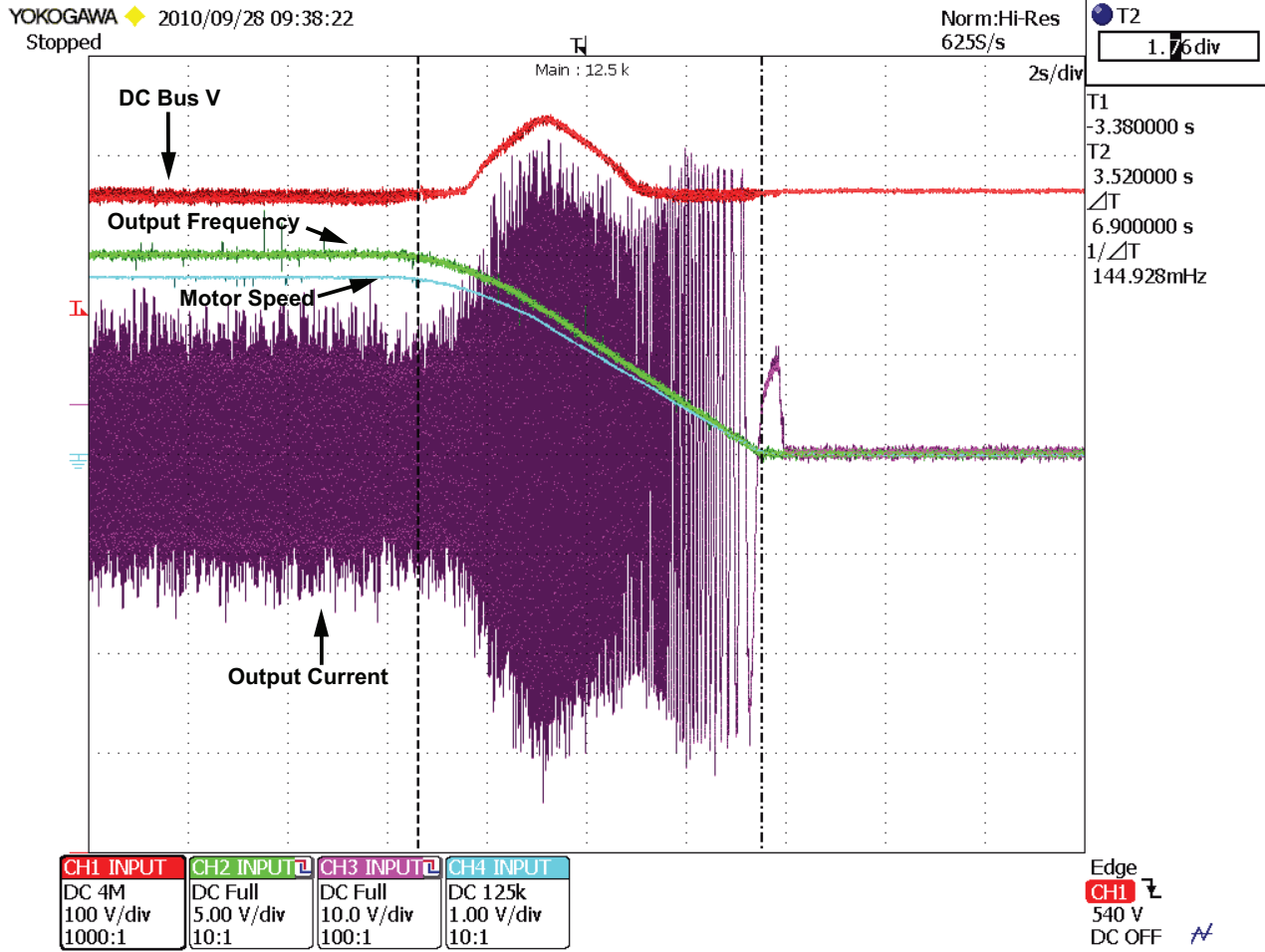

Figure 5 Over-Excitation Braking



### ◆ Self-Activated KEB

Internally activated Kinetic Energy Braking eliminates the need for external voltage sensing relays. Load inertia is used to decelerate the system in a controlled manner in the event of power loss. Extremely fast scan rates accommodate loads near 100 %.

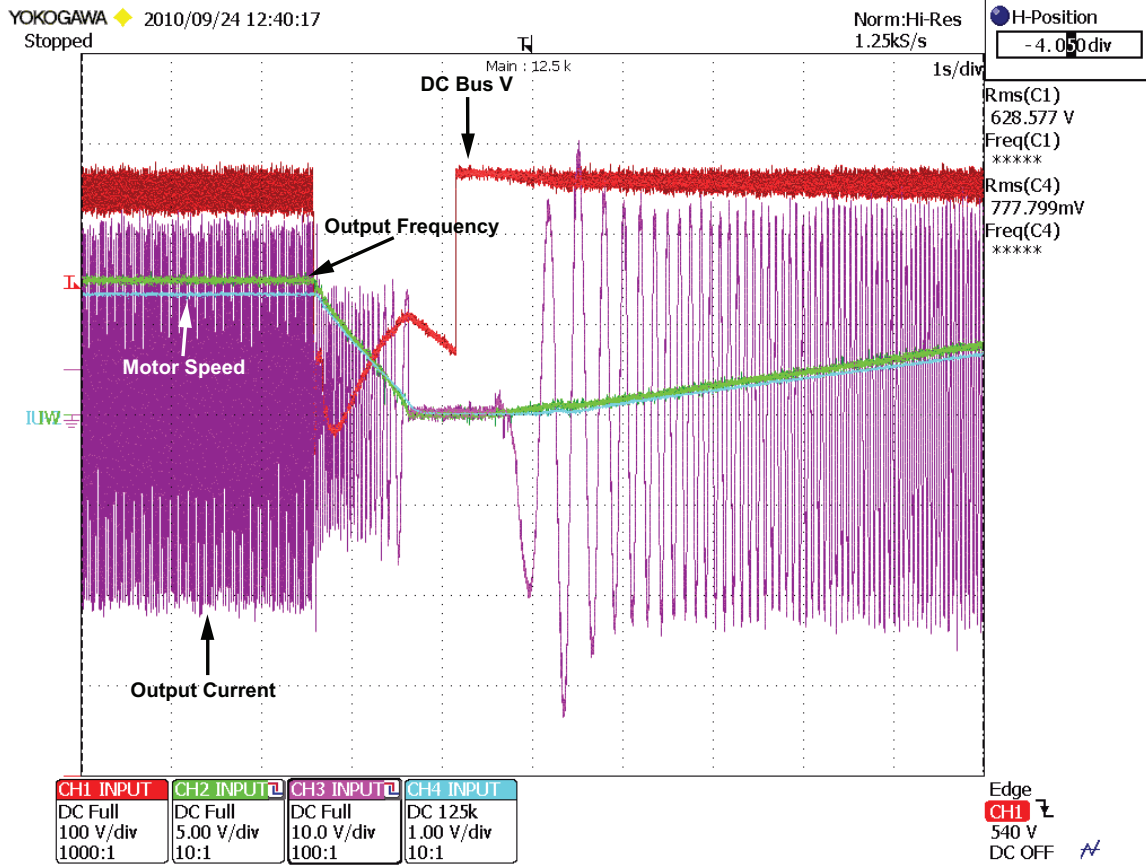

Figure 6 Self-Activated KEB

### ◆ Bidirectional Speed Search

Multiple speed search methods to accommodate nearly any application. Bumpless synchronization with reverse motor rotation is easily accomplished with Speed Estimation Speed Search.

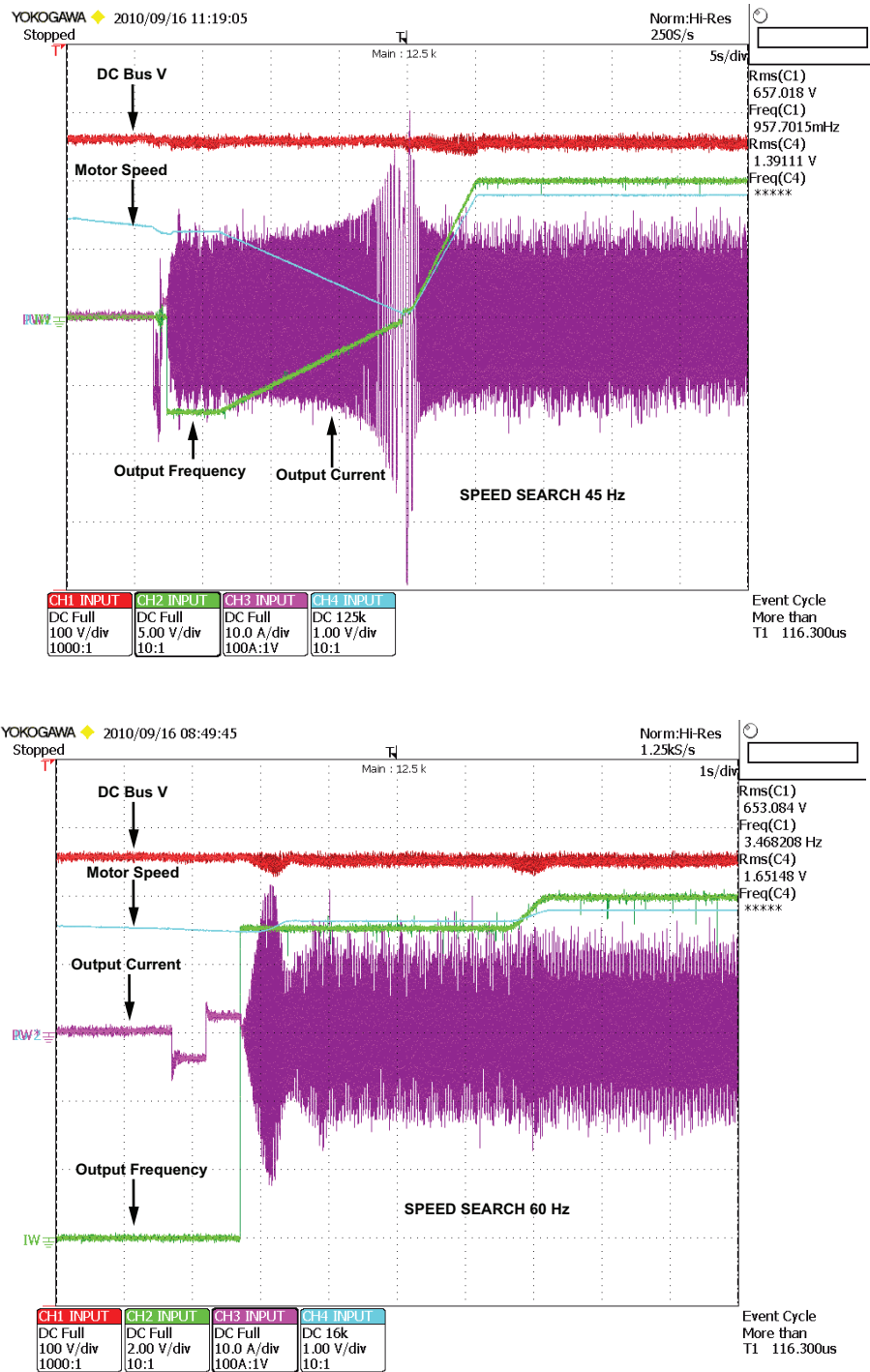

Figure 7 Bi-Directional Speed Search

### ◆ Top Mounted Easily Removable Cooling Fan

The heatsink fan is located on the top of the drive which improves the ease of replacement. With a toolless removal process, faulty fans are easily replaced.

◆ New “Heavy Duty” and “Normal Duty” Ratings for the A1000

The drive’s capacity is rated for two types of load characteristics, Heavy Duty (HD) and Normal Duty (ND). The table below explains the drive characteristics for HD and ND ratings. Parameter C6-01 affects the drives carrier frequency setting, and in certain models, the value of 100 % output current rating is also affected.

Table 7 Drive Selections

C6-01 Setting	Carrier Frequency	Output Current Ratings	Overload Capacity	Maximum Output Frequency
0: Heavy Duty	2 kHz (default) Can be increased w/o derate (Refer to Appendix 1)	HD nameplate rating	150 %	400 Hz
1: Normal Duty (A1000 default)	2 kHz (default) Can be increased with derate (Refer to Appendix 1)	ND nameplate rating  ND rating > HD rating (On certain models, see ratings table)	120 %	400 Hz

Table 8 C6-01 Heavy/Normal Duty Setting

Product	C6-01 Heavy/Normal Duty Setting
New A1000	<p><b>C6-01 Drive Duty Selection Setting</b></p> <p><b>0: Heavy Duty</b></p> <ul style="list-style-type: none"> <li>Rated output current is the HD (Heavy Duty) rating on drive nameplate.</li> <li>Overload capacity is 150 % for 1 minute.</li> <li>Carrier frequency is defaulted to 2 kHz but can be increased to 8 kHz or 5 kHz w/o derating on certain models (Refer to Appendix 1)</li> <li>Carrier frequency is automatically reduced when:                             <ul style="list-style-type: none"> <li>output frequency is &lt; 6.0 Hz and current is &gt;100 %</li> <li>output frequency is &gt; 6.0 Hz and current is &gt; 112 %</li> </ul> </li> <li>Maximum output frequency is 400 Hz (except on larger models)</li> <li>L8-15: OL2 Characteristic selection@low speed (=1 Enabled) expedites OL2 at low output frequencies below 6 Hz.</li> </ul> <p><b>1: Normal Duty (default)</b></p> <ul style="list-style-type: none"> <li>Output current is ND (Normal Duty) rating on drive nameplate.</li> <li>Overload capacity is 120 % for 1 minute</li> <li>Carrier frequency is defaulted to Swing PWM (2kHz) but can be increased with derating on most models (Refer to Appendix 1)</li> <li>Carrier is automatically reduced when:                             <ul style="list-style-type: none"> <li>output frequency is &lt; 6.0 Hz and current is &gt;100 %</li> <li>output frequency is &gt; 6.0 Hz and current is &gt; 112 %</li> </ul> </li> <li>Maximum output frequency is 400 Hz (except on certain larger models)</li> <li>L8-15: OL2 Characteristic selection@low speed (=1 Enabled) expedites OL2 at low output frequencies below 6 Hz.</li> </ul>
F7	<p><b>0: Heavy Duty (default)</b></p> <ul style="list-style-type: none"> <li>Rated output current is HD (Heavy Duty) rating on drive nameplate.</li> <li>Overload Capacity is 150 % for 1 min.</li> <li>Carrier frequency is fixed at 2 kHz</li> <li>Maximum output frequency is 300 Hz.</li> <li>L8-15: OL2 Characteristic selection@low speed (=1 Enabled) expedites OL2 at low output frequencies below 6 Hz.</li> </ul> <p><b>2: Normal Duty 2</b></p> <ul style="list-style-type: none"> <li>Output current is ND (Normal Duty) rating on drive nameplate.</li> <li>Overload capacity varies by model. (See Appendix 1)</li> <li>Setting C6-02 Carrier Frequency greater than default is prohibited. (Default is highest possible setting)</li> <li>Maximum output frequency is 400 Hz.</li> <li>Fixed low speed protection method: Carrier is automatically lowered when output frequency is &lt; 6.0 Hz and current is &gt;100 %.</li> <li>L8-15: OL2 Characteristic selection@low speed (=1 Enabled) expedites OL2 at low output frequencies below 6 Hz.</li> </ul>

# 9 Appendix 1 Ratings

## ◆ Output Amps, Carrier and Overload

**Table 9 240 V Heavy Duty Ratings**

240 V Heavy Duty									
NEC HP 230 V	NEC Amps	A1000 (C6-01 = 0)				F7 Model (C6-01 = 0)			
		A1000 Model CIMR-AU2A	Output Amps Heavy Duty	Fc kHz Heavy Duty <1>	Overload % Heavy Duty	F7 Model CIMR-F7U	Output Amps Heavy Duty	Fc kHz Heavy Duty	OL % Heavy Duty
0.5	2.2	0004	3.2	2 (8)	150	20P41	3.2	2	150
0.75	3.2								
1	4.2	0006	5	2 (8)	150	20P71	4.2	2	150
1.5	6	0008 0010	6.9	2 (8)	150	21P51	7.0	2	150
2	6.8		8						
3	9.6	0012	11	2 (8)	150	22P21	9.6	2	150
		0018	14	2 (8)	150				
5	15.2	0021	17.5	2 (8)	150	23P71	15.2	2	150
7.5	22	0030	25	2 (8)	150	25P51	23	2	150
10	28	0040	33	2 (8)	150	27P51	31	2	150
15	42	0056	47	2 (8)	150	20111	45	2	150
20	54	0069	60	2 (8)	150	20151	58	2	150
25	68	0081	75	2 (8)	150	20181	71	2	150
30	80	0110	85	2 (8)	150	20221	85	2	150
40	104	0138	115	2 (8)	150	20301	115	2	150
50	130	0169	145	2 (5)	150	20371	145	2	150
60	154	0211	180	2 (5)	150	20451	180	2	150
75	192	0250	215	2 (5)	150	20551	215	2	150
100	248	0312	283	2 (5)	150	20751	283	2	150
125	312	0360	346	2 (5)	150	20900	346	2	150
150	360	0415	415	2 (5)	150	21100	360	2	138

<1> Carrier setting in parenthesis indicates maximum value without derating (applies to HD rating only).

**Table 10 240 V Normal Duty Ratings**

240 V Normal Duty									
NEC HP 230 V	NEC Amps	A1000 (C6-01 = 1)				F7 (C6-01 = 2)			
		A1000 Model CIMR-AU2A	Output Amps Normal Duty	Fc kHz Normal Duty	Overload % Normal Duty	F7 Model CIMR-F7U	Output Amps Normal Duty	Fc kHz Normal Duty	Overload % Normal Duty
0.5	2.2	0004	3.5	2 (SPWM)	120	20P41	3.6	10	107
0.75	3.2								
1	4.2	0006	6.0	2 (SPWM)	120	20P71	4.6	10	107
1.5	6								
2	6.8	0008	8.0	2 (SPWM)	120	21P51	7.8	10	108
3	9.6	0010	9.6	2 (SPWM)	120	22P21	10.8	8	107
		0012	12						
5	15.2	0018	17.5	2 (SPWM)	120	23P71	16.8	10	107
7.5	22	0021	21	2 (SPWM)	120	25P51	23	15	120
10	28	0030	30	2 (SPWM)	120	27P51	31	15	102
15	42	0040	40	2 (SPWM)	120	20111	46.2	8	117
20	54	0056	56	2 (SPWM)	120	20151	59.4	10	117

240 V Normal Duty									
NEC HP 230 V	NEC Amps	A1000 (C6-01 = 1)				F7 (C6-01 = 2)			
		A1000 Model CIMR-AU2A	Output Amps Normal Duty	Fc kHz Normal Duty	Overload % Normal Duty	F7 Model CIMR-F7U	Output Amps Normal Duty	Fc kHz Normal Duty	Overload % Normal Duty
25	68	0069	69	2 (SPWM)	120	20181	74.8	10	114
30	80	0081	81	2 (SPWM)	120	20221	88	10	116
40	104	0110	110	2 (SPWM)	120	20301	115	10	120
50	130	0138	138	2 (SPWM)	120	20370	162	5	107
60	154	0169	169	2 (SPWM)	120				
75	192	0211	211	2 (SPWM)	120	20450 20550	192 215	5 8	113 120
100	248	0250	250	2 (SPWM)	120	20750	312	2	109
125	312	0312	312	2 (SPWM)	120				
150	360	0360	360	2 (SPWM)	120	20900 21100	360 415	2	115 120
175	360	0415	415	2 (SPWM)	120				

Table 11 480 V Heavy Duty Ratings

480 V Heavy Duty									
NEC HP 460 V	NEC Amps	A1000 (C6-01 = 0)				F7 (C6-01 = 0)			
		A1000 Model CIMR-AU4A	Output Amps Heavy Duty	Fc kHz Heavy Duty <1>	Overload % Heavy Duty	F7 Model CIMR-F7U	Output Amps Heavy Duty	Fc kHz Heavy Duty	Overload % Heavy Duty
0.5	1.1	0002	1.8	2 (8)	150	40P41	1.8	2	150
0.75	1.6					40P71	2.1	2	150
1	2.1					0004	3.4	2 (8)	150
1.5	3	0005 0007	4.8 5.5	2 (8)	150				
2	3.4	0009	7.2	2 (8)	150	43P71	7.6	2	150
3	4.8					0011	9.2	2 (8)	150
5.0	7.6	0018	14.8	2 (8)	150	45P51	12.5	2	150
7.5	11	0023	18	2 (8)	150	47P51	17	2	150
10	14	0031	24	2 (8)	150	40111	24	2	150
15	21	0038	31	2 (8)	150	40151	31	2	150
20	27	0044	39	2 (8)	150	40181	39	2	150
25	34	0058	45	2 (8)	150	40221	45	2	150
30	40	0072	60	2 (8)	150	40301	60	2	150
40	52	0088	75	2 (8)	150	40371	75	2	150
50	65					0103	91		
60	77	0139	112	2 (5)	150	40551	112	2	150
75	96	0165	150	2 (5)	150	40750	150	2	150
100	124	0208 0250	180 216	2 (5)	150	40900	180	2	150
125	156					41100	216		
150	180	0296	260	2 (5)	150	41320	260	2	150
200	240	0362	304	2 (5)	150	41600	304	2	150
250	302	0414	370	2 (5)	150	41850	370	2	150
300	361	0515	450	2 (2)	150	42200	414	2	150 <2>
350	414	0675	605	2 (2)	150	43000	590	2	150 <2>
400	477								
500	590								

## 9 Appendix 1 Ratings

480 V Heavy Duty									
NEC HP 460 V	NEC Amps	A1000 (C6-01 = 0)				F7 (C6-01 = 0)			
		A1000 Model CIMR-AU4A	Output Amps Heavy Duty	Fc kHz Heavy Duty <1>	Overload % Heavy Duty	F7 Model CIMR-F7U	Output Amps Heavy Duty	Fc kHz Heavy Duty	Overload % Heavy Duty
650	780	0930	810	2 (2)	150	—	—	—	—
900	1080	1200	1090	2 (2)	150	—	—	—	—

<1> Carrier setting in parenthesis indicates maximum without derating (applies to HD rating only).

<2> Heavy Duty overload current rating for model no. 42200 and 43000 is 150% of rated output current for 45 seconds.

**Table 12 480 V Normal Duty Ratings**

480 V Normal Duty									
NEC HP 460 V	NEC Amps	A1000 (C6-01 = 1)				F7 (C6-01 = 2)			
		A1000 Model CIMR-AU4A	Output Amps Normal Duty	Fc kHz Normal Duty	Overload % Normal Duty	F7 Model CIMR-F7U	Output Amps Normal Duty	Fc kHz Normal Duty	Overload % Normal Duty
0.5	1.1	0002	2.1	2 (SPWM)	120	40P41	1.8	15	120
0.75	1.6					40P41			
1	2.1	0004	4.1	2 (SPWM)	120	40P71	2.1	15	120
1.5	3					41P51			
2	3.4					42P21			
3	4.8	0005 0007	5.4 6.9	2 (SPWM)	120	42P21	5.3	15	120
5.0	7.6	0009	8.8	2 (SPWM)	120	43P71	7.6	15	120
						44P01	8.7	15	120
7.5	11	0011	11.1	2 (SPWM)	120	45P51	12.5	15	120
10	14	0018	17.5	2 (SPWM)	120	47P51	17	15	120
15	21	0023	23	2 (SPWM)	120	40111	27	8	107
20	27	0031	31	2 (SPWM)	120				
25	34	0038	38	2 (SPWM)	120	40151	34	10	109
30	40	0044	44	2 (SPWM)	120	40181 40221	40 50.4	10	117 107
						40301	67.2	8	107
40	52	0058	58	2 (SPWM)	120	40371	77	8	117
50	65	0072	72	2 (SPWM)	120				
60	77	0088	88	2 (SPWM)	120	40451	96	8	114
75	96	0103	103	2 (SPWM)	120	40551	125	5	108
100	124	0139	139	2 (SPWM)	120	40750	156	5	115
125	156	0165	165	2 (SPWM)	120	40900	180	8	120
200	240	0250	250	2 (SPWM)	120	41100	240	5	108
						41320	260	5	120
250	302	0296	296	2 (SPWM)	120	41600	304	5	120
300	361	0362	362	2 (SPWM)	120	41850 41850	414	2	107
350	414	0414	414	2 (SPWM)	120				
400	477	0515	515	2 (SPWM)	120	42200	515	2	118
450	515								
500	590	0675	675	2 (SPWM)	120	43000	675	2	120
600	—								
800	—	0930	930	2 (SPWM)	120	—	—	—	—
1000	—	1200	1200	2 (SPWM)	120	—	—	—	—

◆ Drive Derate Charts

■ Carrier Frequency Derate

240 Volt Class Drives:

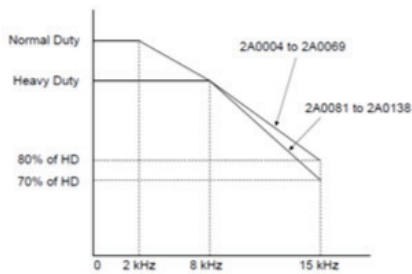

Figure 8 Carrier Frequency Derating (CIMR-A□2A0004 to 2A0138)

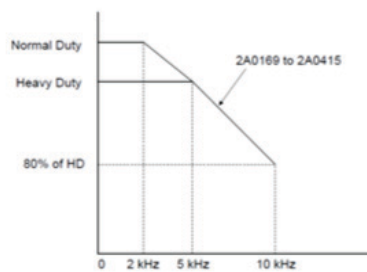

Figure 9 Carrier Frequency Derating (CIMR-A□2A0169 to 2A0415)

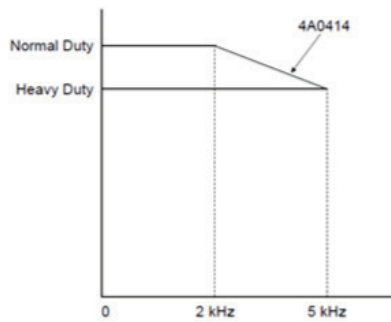

Figure 10 Carrier Frequency Derating (CIMR-A□4A0414)

480 Volt Class Drives:

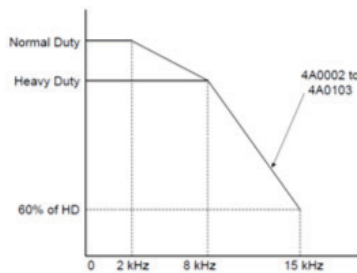

Figure 11 Carrier Frequency Derating (CIMR-A□4A0002 to 4A0103)

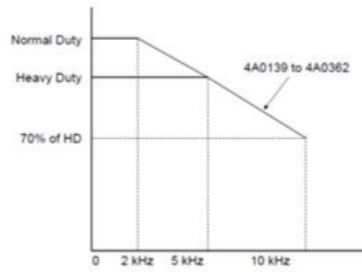

Figure 12 Carrier Frequency Derating (CIMR-A□4A0139 to 4A0362)

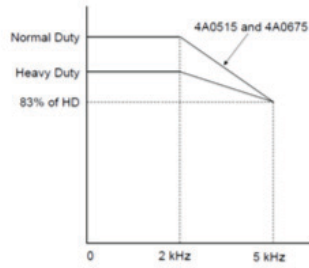

Figure 13 Carrier Frequency Derating (CIMR-A□4A0515 to 4A0675)

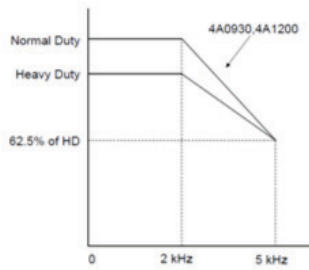

Figure 14 Carrier Frequency Derating (CIMR-A□4A0930 to 4A1200)

■ Temperature Derating

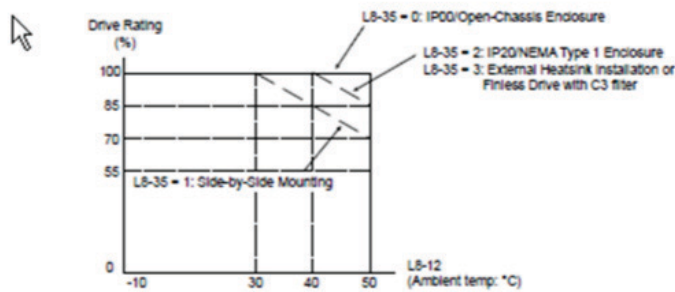

Figure 15 Temperature Derating



■ Altitude Derating

The drive standard ratings are valid for installation altitudes up to 1000 m. For installations from 1000 m to 3000 m, the drive rated output current must be derated for 1 % per 100 m above 1000 m.

■ Dimensions

Table 13 Open-Chassis/IP00

**NOTE:**  
Unshaded cells show drives that are provided with standard NEMA Type 1/IP20 enclosures. Remove the conduit box and top cover plate to convert these drives to Open-Chassis/IP00 enclosure type, then use the Open-Chassis dimensions provided in this table.

Voltage Class	F7 Model F7U	A1000 Model CIMR-AU	Outer Dimensions, Inches (mm)					
			F7			A1000		
			W	H	D	W	H	D
3-Phase 240 V Class	20P4	2A0004	5.51 (140)	11.02 (280)	6.30 (160)	5.51 (140)	10.24 (260)	5.79 (147)
	20P7	2A0006						
	21P5	2A0008 2A0010						
	22P2	2A0012 2A0018						
	23P7	2A0021						
	25P5	2A0030						
	27P5	2A0040	7.87 (200)	11.81 (300)	7.87 (200)	7.09 (180)	11.81 (300)	6.46 (164)
	2011	2A0056	12.2 (310)	7.36 (187)				
	2015	2A0069	9.45 (240)	13.78 (350)	8.27 (210)	8.66 (220)	13.78 (350)	7.76 (197)
	2018	2A0081		14.96 (380)	10.16 (258)			
	2022	2A0110	10.20 (259)	15.75 (400)	10.24 (260)	10.00 (254)	15.75 (400)	10.16 (258)
	2030	2A0138	10.83 (275)	17.72 (450)		10.98 (279)	17.72 (450)	
	2037	2A0169	14.76 (375)	23.62 (600)	11.81 (300)	12.95 (329)	21.65 (550)	11.14 (283)
	2045	2A0211			12.99 (330)			
	2055	2A0250	17.72 (450)	28.54 (725)	13.78 (350)	17.95 (456)	27.76 (705)	12.99 (330)
2075	2A0312	19.69 (500)				33.46 (850)	14.22 (361)	19.84 (504)
2090	2A0360	22.64 (575)	34.84 (885)	14.96 (380)				
3-Phase 480 V Class	40P4	4A0002	5.51 (140)	11.02 (280)	6.30 (160)	5.51 (140)	10.24 (260)	5.79 (147)
	40P7	4A0004						
	41P5							
	42P2	4A0005 4A0007						
	43P7	4A0009						
	44P0	4A0011						
	45P5	4A0018						
	47P5	4A0023	7.87 (200)	11.81 (300)	7.87 (200)	7.09 (180)	11.81 (300)	6.57 (167)
	4011	4A0031	9.45 (240)	13.78 (350)	8.27 (210)			7.09 (180)
	4015	4A0038	10.83 (275)	17.72 (450)	10.24 (260)	8.66 (220)	13.78 (350)	7.76 (197)
	4018	4A0044				10.00 (254)	15.75 (400)	
	4022	4A0058	12.8 (325)	21.65 (550)	11.22 (285)	10.98 (279)	17.72 (450)	10.16 (258)
	4030	4A0072						20.08 (510)
	4037	4A0088	17.72 (450)	28.54 (725)	13.78 (350)	12.95 (329)	21.65 (550)	11.14 (283)
	4045	4A0103						17.72 (450)
4055	4A0139							
4075	4A0165							
4090	4A0208							

## 9 Appendix 1 Ratings

**NOTE:**  
Unshaded cells show drives that are provided with standard NEMA Type 1/IP20 enclosures. Remove the conduit box and top cover plate to convert these drives to Open-Chassis/IP00 enclosure type, then use the Open-Chassis dimensions provided in this table.

Voltage Class	F7 Model F7U	A1000 Model CIMR-AU	Outer Dimensions, Inches (mm)					
			F7			A1000		
			W	H	D	W	H	D
(continued) 3-Phase 480 V Class	4110	4A0250	19.69 (500)	33.46 (850)	14.17 (360)	19.69 (500)	31.5 (800)	13.78 (350)
	4132	4A0296						
	4160	4A0362						
	4185	4A0414	37.40 (950)	57.09 (1450)	17.13 (435)		37.40 (950)	
	4220	4A0515	26.38 (670)	44.88 (1140)				
	4300	4A00675			36.06 (916)	58.07 (1475)	16.34 (415)	
		4A0930	—	—	—	49.21 (1250)	54.33 (1380)	
	4A1200	—	—	—				

**Table 14 NEMA Type 1/IP20**

**NOTE:**  
Models noted with cell shading are provided as standard with Open/IP00 Protected Chassis. Order the appropriate NEMA Type 1/IP20 end cap kit when NEMA 1/IP20 is required for these models.

Voltage Class	F7 Model CIMR-F7U	A1000 Model CIMR-AU	Outer Dimensions, Inches (mm)									
			F7			A1000						
			W	H	D	W	H	D				
3-Phase 240 V Class	20P4	2A0004	5.51 (140)	11.02 (280)	6.30 (160)	5.51 (140)	11.81 (300)	5.79 (147)				
	20P7	2A0006										
	21P5	2A0008 2A0010										
	22P2	2A0012			7.09 (180)			6.46 (164)				
		2A0018										
	23P7	2A0021										
	25P5	2A0030	7.87 (200)	11.81 (300)	7.87 (200)	7.09 (180)	13.39 (340)	7.36 (187)				
	27P5	2A0040										
	2011	2A0056	9.45 (240)	13.78 (350)	8.27 (210)	8.66 (220)	15.75 (400)	7.76 (197)				
	2015	2A0069										
	2018	2A0081			14.96 (380)							
	2022	2A0110	10 (254)	21.06 (535)	10.24 (260)	10.00 (254)	21.02 (534)	10.16 (258)				
	2030	2A0138	10.98 (279)	24.21 (615)	10.24 (260)	10.98 (279)	24.17 (614)	11.14 (283)				
	2037	2A0169	14.76 (375)	31.85 (809)	11.74 (300)	12.95 (329)	28.74 (730)	11.14 (283)				
	2045	2A0211			12.99 (330)							
	2055	2A0250	17.72 (450)	40.44 (1027)	13.78 (350)	17.95 (456)	37.80 (960)	12.99 (330)				
2075	2A0312											
2090	2A0360	19.69 (500)	48.92 (1243)	14.22 (361)	19.84 (504)	45.98 (1168)	13.78 (350)					
3-Phase 480 V Class	40P4	4A0002	5.51 (140)	11.02 (280)	6.30 (160)	5.51 (140)	11.81 (300)	5.79 (147)				
	40P7 41P5	4A0004										
		4A0005							7.09 (180)	6.46 (164)		
	42P2	4A0007										
	43P7 44P0	4A0009 4A0011			7.87 (200)			11.81 (300)	7.87 (200)	7.09 (180)	13.39 (340)	6.57 (167)
	45P5	4A0018										
	47P5	4A0023	9.45 (240)	13.78 (350)	8.27 (210)	8.66 (220)	15.75 (400)	7.76 (197)				
	4011	4A0031										
	4015	4A0038										
4018	4A0044											

**NOTE:** Models noted with cell shading are provided as standard with Open/IP00 Protected Chassis. Order the appropriate NEMA Type 1/IP20 end cap kit when NEMA 1/IP20 is required for these models.

Voltage Class	F7 Model CIMR-F7U	A1000 Model CIMR-AU	Outer Dimensions, Inches (mm)					
			F7			A1000		
			W	H	D	W	H	D
(continued) 3-Phase 480 V Class	4022	4A0058	10.98 (279)	21.06 (535)	10.24 (260)	10.00 (254)	18.31 (465)	10.16 (258)
	4030	4A0072				10.98 (279)	20.28 (515)	
	4037	4A0088	12.95 (329)	25 (635)	11.22 (285)	12.95 (329)	24.80 (630)	
	4045			28.15 (715)			28.74 (730)	11.14 (283)
	-	4A0103	17.72 (450)	40.44 (1027)	13.78 (350)	17.95 (456)	37.80 (960)	12.99 (330)
	4055	4A0139						
	4075	4A0165	19.69 (500)	48.92 (1243)	14.22 (361)	19.84 (504)	45.98 (1168)	13.78 (350)
	4090	4A0208						
		4A0250	23.12 (587)	52.13 (1324)	14.96 (380)	28.43 (722)	70 (1778)	16.34 (415)
	4110	4A0296						
	4132	4A0362	36.54 (928)	76 (1930)	—	—	—	—
	4160	4A0362						
	4185	4A0414	—	—	—	—	—	—
	4220	4A0515						
	4A0675	—	—	—	—	—	—	
4300	4A0930							
	4A1200	—	—	—	—	—	—	

**■ Braking Resistor Installation Attachment**

The F7 allows a braking resistor to be installed directly to the unit on the backside (heatsink). The A1000 requires a special attachment for installation. The table below lists the attachment sizes according to the drive capacity.

The attachment will increase the overall size of the drive when installing a braking resistor to certain A1000 models.

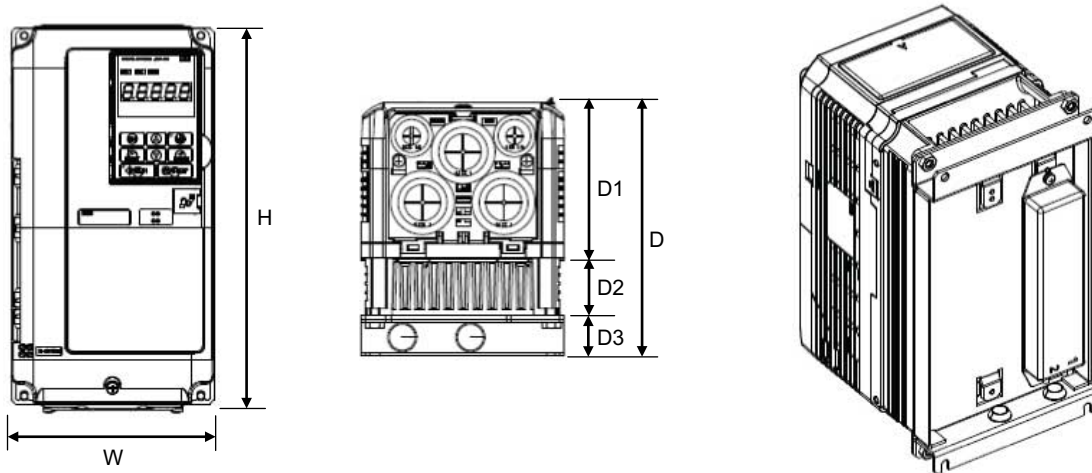

Figure 16 Installing a Braking Resistor on A1000 (240 V class 0.4 kW, or 0.5 HP)

## 9 Appendix 1 Ratings

**Table 15 A1000 Dimensions after Installing Resistor Attachment**

Voltage Class	Capacity HP	Dimensions, inches (mm)											D1, D2, D3 Differences (in)	Attachment for Braking Resistor Model (Parts Code)
		F7					A1000							
		W	H	D1	D2	D	W	H	D1	D2	D3	D		
3-Phase 200 V Class	0.5	5.51 (140)	11.02 (280)	4.65 (118)	1.54 (39)	6.18 (157)	5.51 (140)	10.24 (260)	4.29 (109)	1.5 (38)	1.10 (28)	6.89 (175)	+0.71	EZZ020805A (100-048-123)
	1												+0.71	
	2												+0.71	
	3				+0.71									
	5				2.32 (59)	6.97 (177)				2.17 (55)		7.56 (192)	+0.71	
3-Phase 400 V Class	0.5	5.51 (140)	11.02 (280)	4.65 (118)	1.54 (39)	6.18 (157)	5.51 (140)	10.24 (260)	4.29 (109)	1.5 (38)	1.10 (28)	6.89 (175)	+0.71	
	1												+0.71	
	2												+0.71	
	3				+0.71									
	5				2.32 (59)	6.97 (177)				2.17 (55)		7.56 (192)	+0.71	

**Note:** Use of the braking resistor attachment may void certain vibration and shock requirements, particularly when installed in combination with other attachments for retrofitting A1000 to the F7 installation. For areas where vibration is a major concern, install the braking resistor directly to a separate panel board instead of using the resistor attachment.

**Table 16 Heat Loss Data**

Heat Loss Data (F7 and A1000)										
F7 Model CIMR-F7U	A1000 Model CIMR-AU	F7 Watts			A1000 Watts			A1000 Heat Loss Comparison (% of F7)		Total
		Internal	External	Total	Internal	External	Total	Internal	External	
20P4	2A0004	39	19	58	44	15	59	112.8	78.9	101.7
20P7	2A0006	42	26	68	48	24	72	114.3	92.3	105.9
21P5	2A0008 2A0010	50	48	98	49 52	35 43	84 95	98.0	72.9	85.7
22P2	2A0012 2A0018	59	68	127	58 60	64 77	122 137	98.3	94.1	96.1
23P7	2A0021	74	110	184	67	101	168	90.5	91.8	91.3
25P5	2A0030	84	164	248	92	194	286	109.5	118.3	115.3
27P5	2A0040	113	219	332	105	214	319	92.9	97.7	96.1
2011	2A0056	168	357	525	130	280	410	77.4	78.4	78.1
2015	2A0069	182	416	598	163	395	558	89.6	95.0	93.3
2018	2A0081	208	472	680	221	460	681	106.3	97.5	100.1
2022	2A0110	252	583	835	211	510	721	83.7	87.5	86.3
2030	2A0138	333	883	1216	250	662	912	75.1	75.0	75.0
2037	2A0169	421	1010	1431	306	816	1122	72.7	80.8	78.4
2045	2A0211	499	1228	1727	378	976	1354	75.8	79.5	78.4
2055	2A0250	619	1588	2207	466	1514	1980	75.3	95.3	89.7
2075	2A0312	844	1956	2800	588	1936	2524	69.7	99.0	90.1
2090	2A0360	964	2194	3158	783	2564	3347	81.2	116.9	106.0
2110	2A0415	1234	2733	3967	954	2564	3518	77.3	93.8	88.7
40P4	4A0002	39	14	53	45	16	61	115.4	114.3	115.1
40P7 41P5	4A0004	41 48	17 36	58 84	46	25	71	112.2	147.1	122.4
42P2	4A0005 4A0007	56	59	115	49 53	37 48	87 101	87.5	62.7	75.7
43P7	4A0009	68	80	148	55	53	108	80.9	66.3	73.0
44P0	4A0011	70	90	160	61	69	130	87.1	76.7	81.3
45P5	4A0018	81	127	208	86	135	221	106.2	106.3	106.3
47P5	4A0023	114	193	307	97	150	247	85.1	77.7	80.5
4011	4A0031	158	232	390	115	208	323	72.8	89.7	82.8
4015	4A0038	169	296	465	141	263	404	83.4	88.9	86.9
4018	4A0044	201	389	590	179	330	509	89.1	84.8	86.3
4022	4A0058	233	420	653	170	349	519	73.0	83.1	79.5
4030	4A0072	297	691	988	217	484	701	73.1	70.0	71.0
4037 4045	4A0088	332 386	801 901	1133 1287	254	563	817	76.5	70.3	72.1
—	4A0103	—	—	—	299	723	1022	—	—	—

Heat Loss Data (F7 and A1000)										
F7 Model CIMR-F7U	A1000 Model CIMR-AU	F7 Watts			A1000 Watts			A1000 Heat Loss Comparison (% of F7)		Total
		Internal	External	Total	Internal	External	Total	Internal	External	
4055	4A0139	478	1204	1682	416	908	1324	87.0	75.4	78.7
4075	4A0165	562	1285	1847	580	1340	1920	103.2	104.3	104.0
4090	4A0208	673	1614	2287	541	1771	2312	80.4	109.7	101.1
—	4A0250	—	—	—	715	2360	3075			
4110 4132	4A0296	847 1005	1889 2388	2736 3393	787	2391	3178	92.9	126.6	116.2
4160	4A0362	1144	2791	3935	985	3075	4060	86.1	110.2	103.2
4185	4A0414	1328	2636	3964	1164	3578	4742	87.7	135.7	119.6
4220	4A0515	1712	3797	5509	1386	3972	5358	81.0	104.6	97.3
4300	4A0675	2482	5838	8320	1685	4191	5876	67.9	71.8	70.6
—	4A0930	—	—	—	2455	6912	9367	—	—	—
—	4A1200	—	—	—	3155	7626	10781	—	—	—

◆ Minimum Connectable Resistance

Table 17 Drive Minimum Braking Resistance

F7 Drive Capacity CIMR-F7U	Minimum Connectable Resistance (Ω)
20P1	—
20P2	—
20P4	48
20P7	48
21P5	48
22P2	16
23P7	16
25P5	16
27P5	9.6
2011	9.6
2015	9.6
2018	9.6
40P2	—
40P4	96
40P7	96
41P5	64
42P2	64
43P7	32
44P0	32
45P5	32
47P5	32
4011	20
4015	20
4018	19.2
—	—
—	—
—	—

A1000 Drive Capacity CIMR-AU	Minimum Connectable Resistance (Ω)
2A0004	48
2A0006	48
2A0008	48
2A0010	48
2A0012	16
2A0018	16
2A0021	16
2A0030	16
2A0040	9.6
2A0056	9.6
2A0069	9.6
2A0081	9.6
2A0110	6.4
2A0138	6.4
4A0002	96
4A0004	96
4A0005	64
4A0007	64
4A0009	32
4A0011	32
4A0018	32
4A0023	32
4A0031	20
4A0038	20
4A0044	19.2
4A0058	19.2
4A0072	19.2

# 10 Appendix 2 Parameter Cross Reference

## ◆ Parameter Setting Procedure

1. This document lists the information needed to upgrade from F7 to a new A1000 drive. The A1000 drive must be set for Heavy Duty. First, set A1000 parameter C6-01 to 0.
2. Check all F7 parameters that have been changed from their default settings by using the Modified Constants Menu.
3. Set the same control mode used for F7 to A1000.
4. Set parameters as described in this section.

**Note:** Default Values in the table below are listed for A1000 200 V Class 0.4 kW Drive Using Open Loop Vector Control

**Table 18 Parameter Cross Reference**

Parameter Name		F7		A1000		Setting	
		Parameter	Default	Parameter	Default	F7	A1000
Environment Settings	Language Selection	A1-00	0	A1-00	0	A1-00	A1-00
						0: English	0: English
						1: Japanese	1: Japanese
						2: German	2: German
						3: French	3: French
						4: Italian	4: Italian
						5: Spanish	5: Spanish
						6: Portuguese	6: Portuguese
	—	7: Chinese					
	Access Level Selection	A1-01	2	A1-01	2	A1-01	A1-01
0: Operation only (monitors only)						0: Operation only (monitors only)	
1: User Parameters						1: User Parameters *	
2: All parameters						2: All parameters	
				*Set parameters A2-01 through A2-32			
Environment Settings	Control Method Selection	A1-02	2	A1-02	2	A1-02	A1-02
						0: V/f Control	0: V/f Control
						1: V/f w/PG Control	1: V/f w/PG Control
						2: Open Loop Vector	2: Open Loop Vector
						3: Flux Vector	3: Closed Loop Vector
						—	5: Open Loop Vector for PM
						—	6: Advanced Open Loop Vector for PM
						—	7: Closed Loop Vector for PM
	Initialize Parameters	A1-03	0	A1-03	0	A1-03	A1-03
						0: No initialization	0: No initialization
						1110: User initialize	1110: User initialize
						2220: 2-wire sequence	2220: 2-wire sequence
						3330: 3-wire sequence	3330: 3-wire sequence
						—	5550: Reset OPE04
	Password	A1-04	0	A1-04	0000	—	
	Password Setting	A1-05	0	A1-05	0000	—	
	User Parameters	A2-01 to A2-32	—	A2-01 to A2-32	—	If setting A1-01 to 1, refer to the manual and set parameters A2-01 top A2-32.	

## 10 Appendix 2 Parameter Cross Reference

Parameter Name		F7		A1000		Setting		
		Parameter	Default	Parameter	Default	F7	A1000	
Operation Mode Selection	Frequency Reference Selection	b1-01	1	b1-01	1	b1-01	b1-01	
						0: Operator	0: Operator	
						1: Control circuit terminal (analog input)	1: Control circuit terminal (analog input)	
						2: MEMOBUS comm.	2: MEMOBUS comm.	
	Operation Method Selection	b1-02	1	b1-02	1	b1-02	b1-02	
						0: Operator	0: Operator	
						1: Control circuit terminal	1: Control circuit terminal	
						2: MEMOBUS comm.	2: MEMOBUS comm.	
	Stopping Method Selection	b1-03	0	b1-03	0	b1-03	b1-03	
						0: Ramp to stop	0: Ramp to stop	
						1: Coast to stop	1: Coast to stop	
						2: DC Injection Braking	2: DC Injection Braking	
Operation Mode Selection	Reverse Operation Selection	b1-04	0	b1-04	0	b1-04	b1-04	
						0: Reverse enabled	0: Reverse enabled	
						1: Reverse disabled	1: Reverse disabled	
	Operation Selection for Setting E1-09 or Less	b1-05	0	b1-05	0	b1-05	b1-05	
						0: Run at frequency reference	0: Run at frequency reference	
						1: Shut off drive output	1: Shut off drive output	
						2: Operate by E1-09	2: Operate by E1-09	
	Digital Input Scan Time	b1-06	1	b1-06	1	b1-06	b1-06	
						0: 2 ms - 2 scans	0: 1 ms - 1 scan	
						1: 5 ms - 2 scans	1: 1 ms - 2 scans	
	Operation Selection After Switching to Remote Mode	b1-07	0	b1-07	0	b1-07	b1-07	
						0: Cycle Run command	0: Cycle Run command	
	Run Command Selection while in Programming Mode	b1-08	0	b1-08	0	b1-08	b1-08	
						0: Disabled.	0: Disabled.	
	Run Command at Power Up	—	—	b1-17	0	0: Prohibited 1: Allowed Change b1-17 to 1 to match F7 (Caution: drive will run at power on)		
	DC Injection Braking	DC Injection Braking Start Frequency	b2-01	0.5 Hz	b2-01	0.5 Hz*	*Determined by parameter A1-02, Control Method Selection	
		DC Injection Braking current	b2-02	50%	b2-02	50 %	—	
		DC Injection Braking Time at Start	b2-03	0.00 s	b2-03	0.00 s	—	
DC Injection Braking Time at Stop		b2-04	0.00 s	b2-04	0.50 s*	*Determined by the control mode selected.		
Magnetic Flux Compensation Value		b2-08	0%	b2-08	0%	—		

## 10 Appendix 2 Parameter Cross Reference

Parameter Name		F7		A1000		Setting			
		Parameter	Default	Parameter	Default	F7	A1000		
Speed Search	Speed Search Selection	b3-01	2	b3-01	0*	b3-01	b3-01	b3-24	
						0: Disabled (Speed Estimation)	0: Disabled	1: Speed Estimation	
						1: Enabled (Speed Estimation)	1: Enabled	1: Speed Estimation	
				b3-24	0	2: Disabled (Current Detection)	0: Disabled	0: Current Detection	
						3: Enabled (Current Detection)	1: Enabled	0: Current Detection	
						*Determined by parameter A1-02, Control Method Selection.			
Speed Search Operating Current	b3-02	120 %*	b3-02	120 %*	*Default value changes according to the control mode.				
Speed Search Deceleration Time	b3-03	2.0 s	b3-03	2.0 s	—				
Speed Search	Speed Search Delay Time	b3-05	0.2 s	b3-05	0.2 s	—			
	Speed Search Detection Compensation Gain	b3-10	1.10	b3-10	1.05	—			
	Bi-Directional Speed Search Selection	b3-14	1	b3-14	0*	b3-14	b3-14		
						0: Disabled	0: Disabled		
						1: Enabled	1: Enabled		
	*Determined by the control mode selected								
	Speed Search Restart Current Level	b3-17	150 %	b3-17	150 %	—			
Speed Search Detection Time	b3-18	0.10 s	b3-18	0.10 s	—				
Number of Speed Search Restarts	b3-19	0	b3-19	3	—				
Timers	Timer Function On-Delay Time	b4-01	0.0 s	b4-01	0.0 s	—			
	Timer Function Off-Delay Time	b4-02	0.0 s	b4-02	0.0 s	—			
PID Control	PID Control Method Selection	b5-01	0	b5-01	0	b5-01	b5-01		
						0: Disabled	0: Disabled		
						1: D = feedback	1: D = feedback		
						2: D = feed-forward	2: D = feed-forward		
						3: Freq. Ref. + PID output (D = Feedback)	3: Freq. Ref. + PID output (D = Feedback)		
	4: Freq. Ref. + PID output (D = Feed-forward)	4: Freq. Ref. + PID output (D = Feed-forward)							
	Proportional Gain Setting (P)	b5-02	1.00	b5-02	1.00	—			
	Integral Time Setting (I)	b5-03	1.0 s	b5-03	1.0 s	—			
	Integral Limit Setting	b5-04	100.0 %	b5-04	100.0 %	—			
Derivative Time (D)	b5-05	0.00 s	b5-05	0.00 s	—				
PID Output Limit	b5-06	100.0%	b5-06	100.0 %	—				
PID Offset Tuning	b5-07	0.0 %	b5-07	0.0 %	—				
PID Primary Delay Time	b5-08	0.00 s	b5-08	0.00 s	—				



## 10 Appendix 2 Parameter Cross Reference

Parameter Name		F7		A1000		Setting	
		Parameter	Default	Parameter	Default	F7	A1000
PID Control	PID Output Level Selection	b5-09	0	b5-09	0	b5-09	b5-09
						0: Normal	0: Normal
						1: Reverse	1: Reverse
	PID Output Gain Setting	b5-10	1.0	b5-10	1.00	Minimum setting units vary.	
	PID Output Reverse Selection	b5-11	0	b5-11	0	b5-11	b5-11
						0: Negative PID output triggers zero limit	0: Negative PID output triggers zero limit
						1: Rotation direction reverses with negative PID output.	1: Rotation direction reverses with negative PID output.
	PID Feedback Reference Missing Detection Selection	b5-12	0	b5-12	0	b5-12	b5-12
						0: No Detection	0: No Detection
						1: Alarm	1: Alarm and MFO (@PID enable only)
2: Fault						2: Fault and MFO (@PID enable only)	
—						3: Multi-function output only (no display indication, @ PID enable/disable)	
PID Feedback Loss Detection Level	b5-13	0 %	b5-13	0 %	—		
					PID Feedback Loss Detection Time	b5-14	1.0 s
PID Control	PID Sleep Function Start Level	b5-15	0.0 Hz	b5-15	0.0 Hz	—	
	PID Sleep Delay Time	b5-16	0.0 s	b5-16	0.0 s	—	
	PID Accel/Decel Time	b5-17	0.0 s	b5-17	0.0 s	—	
Dwell Function	Dwell Reference at Start	b6-01	0.0 Hz	b6-01	0.0 Hz	—	
	Dwell Time at Start	b6-02	0.0 s	b6-02	0.0 s	—	
	Dwell Frequency at Stop	b6-03	0.0 Hz	b6-03	0.0 Hz	—	
	Dwell Time at Stop	b6-04	0.0 s	b6-04	0.0 s	—	
Droop Control	Droop Control Level	b7-01	0.0 %	b7-01	0.0 %	—	
	Droop Control Delay Time	b7-02	0.05 s	b7-02	0.05 s	—	
Energy Saving Control	Energy Saving Control Selection	b8-01	0	b8-01	0*	b8-01	b8-01
						0: Energy Saving disabled	0: Energy Saving disabled
						1: Energy Saving enabled	1: Energy Saving enabled
	*Determined by parameter A1-02.						
	Energy Saving Gain	b8-02	1.0	b8-02	*	Determined by parameter A1-02.	
	Energy Saving Control Filter Time Constant	b8-03	Varies by kVA	b8-03	*	Dependent on parameters A1-02, C6-01, and o2-04.	
Energy Saving Coefficient Value	b8-04	Varies by kVA	b8-04	*	Dependent on parameters o2-04 and C6-01. Value changes automatically if E2-11 is manually changed or changed by Auto-Tuning.		
Power Detection Filter Time	b8-05	20 ms	b8-05	20 ms	—		
Search Operation Voltage Limit	b8-06	0 %	b8-06	0 %	—		
Zero Servo	Zero Servo Gain	b9-01	5	b9-01	5	—	
	Zero Servo Completion Width	b9-02	10	b9-02	10	—	

## 10 Appendix 2 Parameter Cross Reference

Parameter Name		F7		A1000		Setting	
		Parameter	Default	Parameter	Default	F7	A1000
Accel/Decel Time	Acceleration Time 1	C1-01	10.0 s	C1-01	10.0 s	—	
	Deceleration Time 1	C1-02	10.0 s	C1-02	10.0 s	—	
	Acceleration Time 2	C1-03	10.0 s	C1-03	10.0 s	—	
	Deceleration Time 2	C1-04	10.0 s	C1-04	10.0 s	—	
	Acceleration Time 3	C1-05	10.0 s	C1-05	10.0 s	—	
	Deceleration Time 3	C1-06	10.0 s	C1-06	10.0 s	—	
	Acceleration Time 4	C1-07	10.0 s	C1-07	10.0 s	—	
	Deceleration Time 4	C1-08	10.0 s	C1-08	10.0 s	—	
	Fast Stop Time	C1-09	10.0 s	C1-09	10.0 s	—	
	Accel/Decel Time Setting Units	C1-10	1	C1-10	1	C1-10	C1-10
						0: 0.01 sec units	0: 0.01 sec units
1: 0.1 sec units						1: 0.1 sec units	
Accel/Decel Switch Frequency	C1-11	0.0 Hz	C1-11	0.0 Hz	—		
S-Curve Characteristics	S-Curve Characteristic at Accel Start	C2-01	0.20 s	C2-01	0.20 s	—	
	S-Curve Characteristic at Accel End	C2-02	0.20 s	C2-02	0.20 s	—	
	S-Curve Characteristic at Decel Start	C2-03	0.20 s	C2-03	0.20 s	—	
	S-Curve Characteristic at Decel End	C2-04	0.00 s	C2-04	0.00 s	—	
Slip Compensation	Slip Compensation Gain	C3-01	1.0	C3-01	1.0*	*Determined by the control mode selected (A1-02).	
	Slip Compensation Primary Delay Time	C3-02	200 ms	C3-02	200 ms*	*Determined by the control mode selected (A1-02).	
	Slip Compensation Limit	C3-03	200 %	C3-03	200 %	—	
	Slip Compensation Selection during Regeneration	C3-04	0	C3-04	0	C3-04	C3-04
						0: Disabled	0: Disabled
	Output Voltage Limit Operation Selection	C3-05	0	C3-05	0	C3-05	C3-05
0: Disabled						0: Disabled	
Torque Compensation	Torque Compensation Gain	C4-01	1.00	C4-01	1.00*	*Determined by the control mode selected (A1-02).	
	Torque Compensation Primary Delay Time	C4-02	20 ms	C4-02	20 ms*	*Determined by the control mode and drive model selected (A1-02 and o2-04).	
	Torque Compensation at Forward Start	C4-03	0.0%	C4-03	0.0 %	—	
	Torque Compensation at Reverse Start	C4-04	0.0%	C4-04	0.0 %	—	
	Torque Compensation Time Constant	C4-05	10 ms	C4-05	10 ms	—	

## 10 Appendix 2 Parameter Cross Reference

Parameter Name		F7		A1000		Setting	
		Parameter	Default	Parameter	Default	F7	A1000
Speed Control (ASR)	ASR Proportional Gain 1	C5-01	20.00	C5-01	20.00*	*Determined by the control mode selected (A1-02). Default shown here is for when using Closed Loop Vector Control.	
	ASR Integral Time 1	C5-02	0.500 sec	C5-02	0.500 sec*		
	ASR Proportional Gain 2	C5-03	20.00	C5-03	20.00*		
	ASR Integral Time 2	C5-04	0.500 sec	C5-04	0.500 sec*		
	ASR Limit	C5-05	5.0 %	C5-05	5.0 %	—	
	ASR Primary Delay Time Constant	C5-06	0.004 sec	C5-06	0.004 sec*	*Determined by the control mode selected (A1-02). Default shown here is for when using Closed Loop Vector.	
	ASR Gain Switching Frequency	C5-07	0.0 Hz	C5-07	0.0 Hz	—	
	ASR Integral Limit	C5-08	400%	C5-08	400%	—	
Carrier Frequency	Drive Duty Selection	C6-01	0	C6-01	1	Parameter contents differ between F7 and A1000	
						C6-01	C6-01
						0: Heavy Duty	0: Heavy Duty
						1: Normal Duty 1 2: Normal Duty 2	1: Normal Duty
	Carrier Frequency Selection	C6-02	Varies by kVA	C6-02	*	C6-02	
						C6-02	C6-02
						0: Low Noise PWM	—
						1: 2.0 kHz	1: 2.0 kHz
						2: 5.0 kHz	2: 5.0 kHz
						3: 8.0 kHz	3: 8.0 kHz
						4: 10.0 kHz	4: 10.0 kHz
5: 12.5 kHz						5: 12.5 kHz	
6: 15.0 kHz	6: 15.0 kHz						
—	7 to A: Swing PWM 1-4						
—	B to E: No setting possible						
F: User-set	F: User-set						
				*Dependent on A1-02, C6-01, and o2-04.			
Carrier Frequency Upper Limit	C6-03	Varies by kVA	C6-03	*	*Dependent on C6-02.		
Carrier Frequency Lower Limit	C6-04	Varies by kVA	C6-04	*	*Dependent on C6-02.		
Carrier Frequency Proportional Gain	C6-05	0	C6-05	*	*Dependent on C6-02.		
Frequency Reference	Frequency Reference 1	d1-01	0.00 Hz	d1-01	0.00 Hz	—	
	Frequency Reference 2	d1-02	0.00 Hz	d1-02	0.00 Hz	—	
	Frequency Reference 3	d1-03	0.00 Hz	d1-03	0.00 Hz	—	
	Frequency Reference 4	d1-04	0.00 Hz	d1-04	0.00 Hz	—	
	Frequency Reference 5	d1-05	0.00 Hz	d1-05	0.00 Hz	—	
	Frequency Reference 6	d1-06	0.00 Hz	d1-06	0.00 Hz	—	
	Frequency Reference 7	d1-07	0.00 Hz	d1-07	0.00 Hz	—	
	Frequency Reference 8	d1-08	0.00 Hz	d1-08	0.00 Hz	—	
	Frequency Reference 9	d1-09	0.00 Hz	d1-09	0.00 Hz	—	
	Frequency Reference 10	d1-10	0.00 Hz	d1-10	0.00 Hz	—	
	Frequency Reference 11	d1-11	0.00 Hz	d1-11	0.00 Hz	—	
	Frequency Reference 12	d1-12	0.00 Hz	d1-12	0.00 Hz	—	
	Frequency Reference 13	d1-13	0.00 Hz	d1-13	0.00 Hz	—	
	Frequency Reference 14	d1-14	0.00 Hz	d1-14	0.00 Hz	—	

## 10 Appendix 2 Parameter Cross Reference

Parameter Name		F7		A1000		Setting					
		Parameter	Default	Parameter	Default	F7		A1000			
Frequency Reference	Frequency Reference 15	d1-15	0.00 Hz	d1-15	0.00 Hz	—					
	Frequency Reference 16	d1-16	0.00 Hz	d1-16	0.00 Hz	—					
	Jog Frequency Reference	d1-17	6.00 Hz	d1-17	6.00 Hz	—					
Frequency Limits	Frequency Reference Upper Limit Value	d2-01	100.0 %	d2-01	100.0%	—					
	Frequency Reference Lower Limit Value	d2-02	0.0 %	d2-02	0.0%	—					
	Main Speed Reference Lower Limit Value	d2-03	0.0 %	d2-03	0.0%	—					
Jump Frequency	Jump Frequency 1	d3-01	0.0 Hz	d3-01	0.0 Hz	—					
	Jump Frequency 2	d3-02	0.0 Hz	d3-02	0.0 Hz	—					
	Jump Frequency 3	d3-03	0.0 Hz	d3-03	0.0 Hz	—					
	Jump Frequency Width	d3-04	1.0 Hz	d3-04	*	*Determined by parameter A1-02.					
Frequency Reference Hold	Frequency Reference Hold Function Selection	d4-01	0	d4-01	0	d4-01		d4-01			
						0: Disabled		0: Disabled			
						1: Enabled		1: Enabled			
	Trim Control Level	d4-02	10 %	d7-01	0.0 %	H1-01 to H1-06	d4-02	H1-01 to H1-08	d7-01	d7-02	H1-01 to H1-06
			d7-02	0.0 %	1C:+Speed Ref	Setting value	44	Setting value	No need to set	1C:+Speed Ref	
					1D: -Speed Ref	Setting value	45	No need to set	-(Setting Value)	1D: -Speed Ref	
Torque Control	Torque Control Selection	d5-01	0	d5-01	0	d5-01		d5-01			
						0: Speed Control		0: Speed Control			
						1: Torque Control		1: Torque Control			
	Torque Reference Delay Time	d5-02	0 ms	d5-02	0 ms	—					
	Speed Limit Selection	d5-03	1	d5-03	1	d5-03		d5-03			
						1: Analog Input		1: Limited by b1-01			
						2: Program Setting		2: Limited by d5-04			
Speed Limit	d5-04	0%	d5-04	0%	—						
Speed Limit Bias	d5-05	10%	d5-05	10%	—						
Speed/Torque Control Switchover Timer	d5-06	0 ms	d5-06	0 ms	—						
Magnetic Field Control	Field Weakening Level	d6-01	80 %	d6-01	80 %	—					
	Field Frequency	d6-02	0.0 Hz	d6-02	0.0 Hz	—					
	Field Forcing Function Selection	d6-03	0	d6-03	0	d6-03		d6-03			
						0: Disabled		0: Disabled			
						1: Enabled		1: Enabled			
Field Forcing Limit	d6-06	400 %	d6-06	400 %	—						
V/f Characteristics	Input Voltage Setting	E1-01	200 V*	E1-01	230 V*	*Double values for 400 V class drives.					

## 10 Appendix 2 Parameter Cross Reference

Parameter Name		F7		A1000		Setting	
		Parameter	Default	Parameter	Default	F7	A1000
V/f Characteristics	V/f Pattern Selection	E1-03	F	E1-03	F	E1-03	E1-03
						0: 50 Hz	0: 50 Hz (constant torque 1)
						1: 60 Hz saturation	1: 60 Hz (constant torque 2)
						2: 50 Hz saturation	2: 60 Hz (constant torque 3), 50 Hz base
						3: 72 Hz, 60 Hz base	3: 72 Hz (constant torque 4), 60 Hz base
						4: 50 Hz VT1	4: 50 Hz VT1
						5: 50 Hz VT2	5: 50 Hz VT2
						6: 60 Hz VT1	6: 60 Hz VT3
						7: 60 Hz VT2	7: 60 Hz VT4
						8: 50 Hz HST1	8: 50 Hz HST1
						9: 50 Hz HST2	9: 50 Hz HST2
						A: 60 Hz HST1	A: 60 Hz HST3
						B: 60 Hz HST2	B: 60 Hz HST4
						C: 90 Hz (60 Hz base)	C: 90 Hz (60 Hz base)
						D: 120 Hz (60 Hz base)	D: 120 Hz (60 Hz base)
E: 180 Hz (60 Hz base)	E: 180 Hz (60 Hz base)						
F: Custom V/f pattern	F: Custom V/f pattern						
FF: Custom w/o limit	—						
	Max Output Frequency	E1-04	60.0 Hz	E1-04	60.0 Hz *	*Depends on the parameters A1-02, C6-01, o2-04, and E5-01	
	Max Voltage	E1-05	230.0 V*	E1-05	*	*Double values for 400 V class drives. Depends on the parameters A1-02, C6-01, o2-04, and E5-01	
	Base Frequency	E1-06	60.0 Hz *	E1-06	*	*Depends on the control mode and the V/f pattern selected. Depends on the parameters A1-02, C6-01, o2-04, and E5-01	
	Mid. Output Frequency	E1-07	3.0 Hz *	E1-07	3.0 Hz	*Depends on the control mode and the V/f pattern selected. Depends on the parameters A1-02, C6-01, and o2-04	
	Mid. Output Frequency Voltage	E1-08	12.6 V or 25.3 V*	E1-08	*	*Depends on the control mode and the V/f pattern selected. Double values for 400 V class drives. Depends on the parameters A1-02, C6-01, and o2-04 in A1000 drives	
	Minimum Output Frequency	E1-09	0.5 Hz *	E1-09	*	*Depends on the control mode and the V/f pattern selected. Depends on the parameters A1-02, C6-01, o2-04, and E5-01	
	Minimum Output Frequency Voltage	E1-10	2.3 V or 4.6 V*	E1-10	*	*Depends on the control mode and the V/f pattern selected. Double values for 400 V class drives. Depends on the parameters A1-02, C6-01, and o2-04	
	Mid. Output Frequency 2	E1-11	0.0 Hz	E1-11	0.0 Hz	—	
V/f Characteristic	Mid. Output Frequency Voltage 2	E1-12	0.0 V	E1-12	0.0 V	—	
	Base Voltage	E1-13	0.0 V	E1-13	0.0 V	—	
Motor Parameters	Motor Rated Current	E2-01	*	E2-01	*	—	
	Motor Rated Slip	E2-02	*	E2-02	*	*Varies by kVA; for A1000, dependent on parameters C6-01 and o2-04	
	Motor No-Load Current	E2-03	*	E2-03	*	*Varies by kVA; for A1000, dependent on parameters C6-01 and o2-04	
	Number of Motor Poles	E2-04	4 poles	E2-04	4 poles	—	
	Motor Line-to-Line Resistance	E2-05	*	E2-05	*	*Varies by kVA; for A1000, dependent on parameters C6-01 and o2-04	
	Motor Leakage Inductance	E2-06	*	E2-06	*	*Varies by kVA; for A1000, dependent on parameters C6-01 and o2-04	
	Motor Iron Core Saturation Co-Efficient 1	E2-07	0.50	E2-07	0.50	—	
	Motor Iron Core Saturation Co-Efficient 2	E2-08	0.75	E2-08	0.75	—	
	Motor Mechanical Loss	E2-09	0.0 %	E2-09	0.0 %	—	
	Motor Iron Loss for Torque Compensation	E2-10	*	E2-10	*	*Varies by kVA; for A1000, dependent on parameters C6-01 and o2-04	
	Motor Rated Output	E2-11	*	E2-11	*	*Varies by kVA; for A1000, dependent on parameters C6-01 and o2-04	

## 10 Appendix 2 Parameter Cross Reference

Parameter Name		F7		A1000		Setting		
		Parameter	Default	Parameter	Default	F7	A1000	
Motor 2 V/f Characteristics	Motor 2 Control Method Selection	E3-01	2	E3-01	0	E3-01	E3-01	
						0: V/f	0: V/f	
						1: V/f w/PG	1: V/f w/PG	
						2: Open Loop Vector	2: Open Loop Vector	
							3: Flux Vector Control	3: Closed Loop Vector
	Motor 2 Max Output Frequency	E3-02	60.0 Hz	E3-04	*	*Dependent on E3-01 and control method selected		
	Motor 2 Max Voltage	E3-03	230 V or 460 V*	E3-05	*	*Dependent on E3-01 and control method selected Double values for 400 V class drives		
	Motor 2 Base Frequency	E3-04	60.0 Hz	E3-06	*	*Dependent on E3-01 and control method selected		
Motor 2 Mid. Output Frequency	E3-05	3.0 Hz	E3-07	*	*Dependent on E3-01 and control method selected			
Motor 2 Mid. Output Voltage VA	E3-06	12.6 V or 25.3 V*	E3-08	*	*Dependent on E3-01 and control method selected Double values for 400 V class drives			
Motor 2 Minimum Output Frequency	E3-07	0.5 Hz	E3-09	*	*Dependent on E3-01 and control method selected			
Motor 2 Minimum Output Voltage	E3-08	2.3 V or 4.6 V	E3-10	*	*Dependent on E3-01 and control method selected Double values for 400 V class drives			
Motor 2 Parameter	Motor 2 Rated Current	E4-01	*	E4-01	*	*Varies by kVA; A1000 dependent on C6-01 and o2-04		
	Motor 2 Rated Slip	E4-02	*	E4-02	*	*Varies by kVA; A1000 dependent on C6-01 and o2-04		
	Motor 2 No-Load Current	E4-03	*	E4-03	*	*Varies by kVA; A1000 dependent on C6-01 and o2-04		
	Motor 2 Number of Poles	E4-04	4	E4-04	4	—		
	Motor 2 Line-to-Line Resistance	E4-05	*	E4-05	*	*Varies by kVA; A1000 dependent on C6-01 and o2-04		
	Motor 2 Leakage Inductance	E4-06	*	E4-06	*	*Varies by kVA; A1000 dependent on C6-01 and o2-04		
	Motor 2 Rated Output	E4-07	*	E4-11	*	*Varies by kVA; A1000 dependent on C6-01 and o2-04		
PG speed Control Card	PG 1 Pulses Per Revolution	F1-01	1024	F1-01	1024	—		
	Operation Selection at PG Open Circuit (PGO)	F1-02	1	F1-02	1	F1-02	F1-02	
						0: Ramp to stop	0: Ramp to stop	
						1: Coast to stop	1: Coast to stop	
						2: Fast Stop	2: Fast Stop	
							3: Alarm Only	3: Alarm Only
							—	4: No Alarm Display
	Operation Selection at Overspeed (OS)	F1-03	1	F1-03	1	F1-03	F1-03	
						0: Ramp to stop	0: Ramp to stop	
						1: Coast to stop	1: Coast to stop	
						2: Fast Stop	2: Fast Stop	
							3: Alarm Only	3: Alarm Only
	Operation Selection at Deviation	F1-04	3	F1-04	3	F1-04	F1-04	
						0: Ramp to stop	0: Ramp to stop	
						1: Coast to stop	1: Coast to stop	
						2: Fast Stop	2: Fast Stop	
						3: Alarm Only	3: Alarm Only	
PG 1 Rotation Selection	F1-05	0	F1-05	0*	F1-05	F1-05		
					0: FWD = Phase A leads	0: FWD = Phase A leads		
					1: FWD = Phase B leads	1: FWD = Phase B leads		
					*Determined by parameter A1-02			

## 10 Appendix 2 Parameter Cross Reference

Parameter Name		F7		A1000		Setting			
		Parameter	Default	Parameter	Default	F7	A1000		
PG speed Control Card	PG Division Rate (PG Pulse Monitor)	F1-06	1	F1-06	1	Enabled when using the PG-B2 option card.			
	Integral Function During Accel/Decel Selection	F1-07	0	C5-12	0	F1-07		C5-12	
						0: Disabled	0: Disabled		
						1: Enabled	1: Enabled		
	Overspeed Detection Level	F1-08	115 %	F1-08	115 %	—			
	Overspeed Detection Delay Time	F1-09	0.0 s	F1-09	*	*Determined by parameter A1-02			
	Excessive Speed Deviation Detection Level	F1-10	10%	F1-10	10 %	—			
	Excessive Speed Deviation Detection Delay Time	F1-11	0.5 s	F1-11	0.5 s	—			
	Number of PG Gear Teeth 1	F1-12	0	F1-12	0	—			
Number of PG Gear Teeth 2	F1-13	0	F1-13	0	—				
PG Open-Circuit Detection Time	F1-14	2.0 s	F1-14	2.0 s	—				
Analog Command Card	AI-14 Input Selection	F2-01	0	F2-01	0	F2-01		F2-01	
						0: Separate channels	0: Separate channels		
						1: Sum of channel values	1: Sum of channel values		
Digital Command Card	DI-08/DI-16H2 Input Selection	F3-01	0	F3-01	0	*The digital option card determines the setting			
						DI-08: 0 (8 bit)			
						DI-16H: Set switch S1 to determine input signal:			
						S1 switch 1: 2 (16 bit) S1 switch S1: 1 (12 bit)			
	Digital Input Option DI-A3 Data Length Selection	—	—	—	F3-03	2*	F3-01		F3-01
							0: BCD 1% units	0: BCD 1% units	0: 8 bit
							1: BCD 0.1% units	1: BCD 0.1% units	1: 12 bit
							2: BCD 0.01% units	2: BCD 0.01% units	2: 16 bit
							3: BCD 1 Hz units	3: BCD 1 Hz units	—
							4: BCD 0.1 Hz units	4: BCD 0.1 Hz units	—
5: BCD 0.01 Hz units	5: BCD 0.01 Hz units	—							
6: BCD customized setting (5-digit), 0.01 Hz units	6: BCD customized setting (5-digit), 0.02 Hz units	—							
7: Binary input	7: Binary input	—							

## 10 Appendix 2 Parameter Cross Reference

Parameter Name		F7		A1000		Setting										
		Parameter	Default	Parameter	Default	F7	A1000									
Analog Monitor Card	Channel 1 Monitor Selection	F4-01	2	F4-01	102	F4-01, F4-03, H4-01, H4-04, o1-01	F4-01, F4-03, H4-01, H4-04, o1-01									
						01: Frequency reference	101: Frequency reference									
						02: Output frequency	102: Output frequency									
						03: Output current	103: Output current									
						05: Motor speed	105: Motor speed									
						06: Output voltage reference	106: Output voltage reference									
						07: Main circuit DC voltage	107: Main circuit DC voltage									
						08: Output power	108: Output power									
						09: Torque ref (Internal)	109: Torque ref (Internal)									
						15: Freq ref, A1 voltage	113: Freq ref, A1 voltage									
						16: Freq ref, A2 voltage	114: Freq ref, A2 voltage									
						17: Freq ref, A3 voltage	115: Freq ref, A3 voltage									
						18: Secondary current (Iq)	601: Secondary current (Iq)									
						19: Motor excitation current (Id)	602: Motor excitation current (Id)									
						20: Output after soft start	116: Output after soft start									
						21: ASR input	603: ASR input									
						22: ASR output	604: ASR output									
						24: PID feedback amount	501: PID feedback amount									
						26: Output voltage ref (Vq)	605: Output voltage ref (Vq)									
27: Output voltage ref (Vd)	606: Output voltage ref (Vd)															
Analog Monitor Card	Channel 1 Monitor Selection	F4-01	2	F4-01	102	32: ACR output (q-axis)	607: ACR output (q-axis)									
						33: ACR output (d-axis)	608: ACR output (d-axis)									
						36: PID input amount	502: PID input amount									
						37: PID output amount	503: PID output amount									
						38: PID setpoint	504: PID setpoint									
						44: ASR output , no filter	625: ASR output , no filter									
	45: Feed Forward output	626: Feed Forward output														
	Terminal V1 Monitor Gain	F4-02	100.0 %	F4-02	100.0 %	—										
						Terminal V2 Monitor Selection	F4-03	3*	F4-03	103*	*See the comments column for F4-01.					
											Terminal V2 Monitor Gain	F4-04	50.0 %	F4-04	50.0 %	—
																Terminal V1 Monitor Bias
						Terminal V2 Monitor Bias	F4-06	0.0 %	F4-06	0.0 %	—					
											Terminal V1 Signal Level	F4-07	0	F4-07	0	F4-07
						0: 0 to 10 V	0: 0 to 10 V									
						1: -10 to +10 V	1: -10 to +10 V									
Terminal V2 Signal Level						F4-08	0	F4-08	0	F4-08	F4-08					
	0: 0 to 10 V	0: 0 to 10 V														
	1: -10 to +10 V	1: -10 to +10 V														



## 10 Appendix 2 Parameter Cross Reference

Parameter Name		F7		A1000		Setting			
		Parameter	Default	Parameter	Default	F7	A1000		
Digital Output Card	Terminal P1-PC Output Selection	F5-01	0*	F5-01	2*	*See the Comments column on page 32 for H2-01 through H2-03.			
	Terminal P2-PC Output Selection	F5-02	1*	F5-02	4*				
	Terminal P3-PC Output Selection	F5-03	2*	F5-03	6*				
	Terminal P4-PC Output Selection	F5-04	4*	F5-04	37*				
	Terminal P5-PC Output Selection	F5-05	6*	F5-05	F*				
	Terminal P6-PC Output Selection	F5-06	37*	F5-06	F*				
	Terminal M1-M2 Output Selection	F5-07	F*	F5-07	0*				
	Terminal M3-M4 Output Selection	F5-08	F*	F5-08	1*				
	DO-08/DO-A3 Output Mode Selection		F5-09	0	F5-09	0	F5-09	F5-09	
							0	F5-01=0	0
F5-02=1								F5-02=1	
F5-03=2								F5-03=2	
F5-04=4								F5-04=4	
F5-05=6								F5-05=6	
F5-06=37								F5-06=37	
F5-07=F								F5-07=F	
F5-08=F								F5-08=F	
1: Binary code output							1: Binary code output		
2: 8-channel Selected - Output according to F5-01 to 08			2: 8-channel Selected - Output according to F5-01 to 08						
Communication Option Card	Operation Selection After Communications Error	F6-01	1	F6-01	1	F6-01	F6-01		
						0: Ramp to stop		0: Ramp to stop	
						1: Coast to stop		1: Coast to stop	
						2: Fast Stop		2: Fast Stop	
						3: Alarm Only		3: Alarm Only	
	External Fault from Comm. Option Board Detection Selection	F6-02	0	F6-02	0	F6-02	F6-02		
						0: Always detected		0: Always detected	
						1: Detected during run		1: Detected during run	
	External Fault from Comm. Option Board Operation Selection	F6-03	1	F6-03	1	F6-03	F6-03		
						0: Ramp to stop		0: Ramp to stop	
1: Coast to stop						1: Coast to stop			
3: Alarm Only						3: Alarm Only			
Trace Sampling from Comm. Option Board	F6-04	0	—	—	F6-04 corresponds to bUS Error Detection Time (default: 2.0 sec) in A1000.				
Torque Reference/ Torque Limit Selection from Communications Option	F6-06	0	F6-06	0	0: Switching via comm. network is disabled				
					F6-06	F6-06			
					0: Disabled		0: Disabled		
1: Enabled		1: Enabled							
NetRef/ComRef Selection	—	—	F6-07	0	Disable multi-step speed by setting F6-07 to 0. Enable by setting F6-07 to 1.				
Operation Selection at Watchdog Timer Error	—	—	F6-25	1	Parameter F6-25 set to 1 enables coast to stop. 0 = Ramp to stop using time in C1-02; 2 = Fast stop using time in C1-09; 3 = Alarm Only				
MECHATRO-LINK bUS Error Detection	—	—	F6-26	2	Sets the number of option communication errors (bUS) with a range of 2 to 10.				

## 10 Appendix 2 Parameter Cross Reference

Parameter Name		F7		A1000		Setting	
		Parameter	Default	Parameter	Default	F7	A1000
Multi-Function Relay Input	Multi-Function Digital Input Terminal S1 Function Selection	—	—	H1-01*	40 Use this setting	*Input functions for terminals S1 and S2 are fixed in F7, but multi-functional in A1000.	
						H1-01 to H1-06 (S3-S8)	H1-01 to H1-08 (S1-S8)
						0: 3-wire sequence	0: 3-wire sequence
						1: LOCAL/REMOTE selection	1: LOCAL/REMOTE selection
						2: Option/Drive selection	2: External Ref. ½ Selection b1-15* b1-16* 3: Option card 3: Option card *Used when closed. When open, source is determined by b1-01 and b1-02
						3: Multi-Step Frequency Ref. 1	3: Multi-Step Frequency Ref. 1
						4: Multi-Step Frequency Ref. 2	4: Multi-Step Frequency Ref. 2
	Multi-Function Digital Input Terminal S2 Function Selection	—	—	H1-02*	41 Use this setting	5: Multi-Step Frequency Ref. 3	5: Multi-Step Frequency Ref. 3
						6: Jog freq ref selection	6: Jog freq ref selection
						7: Accel/Decel Time Selection 1	7: Accel/decel time selection 1
						8: External Baseblock (N.O.)	8: External Baseblock (N.O.)
						9: External Baseblock (N.C.)	9: Baseblock command (N.C.)
						A: Accel/decel Ramp Hold	A: Accel/decel ramp hold
						B: External overheat alarm (OH2)	B: Drive overheat alarm
	Terminal S3 Function Selection	H1-01	24	H1-03	24	C: Terminal A2 Enable	C: Analog Terminal input selection
						D: V/f with PG Disabled	D: PG encoder disable
						E: ASR integral reset	E: ASR integral reset
						F: Not used	F: Through-mode
						10: MOP Increase	10: Up command
						11: MOP Decrease	11: Down command
						12: FWD jog	12: FWD jog
	13: REV jog	13: REV jog					
	Terminal S4 Function Selection	H1-02	14	H1-04	14	14: Fault Reset	14: Fault Reset
						15: Fast Stop (N.O.)	15: Fast Stop (N.O.)
16: Motor 2 selection						16: Motor 2 selection	
17: Fast Stop (N.C.)						17: Fast Stop (N.C.)	
18: Timer function input						18: Timer function input	
19: PID disable						19: PID disable	
1A: Accel/decel time selection 2						1A: Accel/decel time selection 2	
1B: Program Lockout	1B: Program Lockout						

## 10 Appendix 2 Parameter Cross Reference

Parameter Name		F7		A1000		Setting	
		Parameter	Default	Parameter	Default	F7	A1000
Multi-Function Relay Input	Terminal S5 Function Selection	H1-03	3 (0)	H1-05	3 (0)	1C: Trim Control Increase	—
						1D: Trim Control Decrease	—
						1E: Analog freq ref sample hold	1E: Analog freq ref sample/hold
						20: External fault (N.O., Always detected, Ramp to stop)	20: External fault (N.O., Always detected, Ramp to stop)
						21: External fault (N.C., Always detected, Ramp to stop)	21: External fault (N.C., Always detected, Ramp to stop)
						22: External fault (N.O., Detected during run, Ramp to stop)	22: External fault (N.O., Detected during run, Ramp to stop)
						23: External fault (N.C., Detected during run, Ramp to stop)	23: External fault (N.C., Detected during run, Ramp to stop)
						24: External fault (N.O., Always detected, Coast to stop)	24: External fault (N.O., Always detected, Coast to stop)
						25: External fault (N.C., Always detected, Coast to stop)	25: External fault (N.C., Always detected, Coast to stop)
						26: External fault (N.O., Detected during run, Coast to stop)	26: External fault (N.O., Detected during run, Coast to stop)
						27: External fault (N.C., Detected during run, Coast to stop)	27: External fault (N.C., Detected during run, Coast to stop)
						28: External Fault (N.O., always detected, Fast Stop)	28: External Fault (N.O., always detected, Fast Stop)
	Terminal S5 Function Selection	H1-03	3 (0)	H1-05	3 (0)	29: External fault (N.C., always detected, Fast Stop)	29: External fault (N.C., always detected, Fast Stop)
						2A: External Fault (N.O., detected during run, Fast Stop)	2A: External Fault (N.O., detected during run, Fast Stop)

## 10 Appendix 2 Parameter Cross Reference

Parameter Name		F7		A1000		Setting	
		Parameter	Default	Parameter	Default	F7	A1000
Multi-Function Relay Input	Terminal S6 Function Selection	H1-04	4 (3)	H1-06	4 (3)	2B: External fault (N.C., detected during run, Fast Stop)	2B: External fault (N.C., detected during run, Fast Stop)
						2C: External fault (N.O., always detected, alarm only)	2C: External fault (N.O., always detected, alarm only)
						2D: External fault (N.C., always detected, alarm only)	2D: External fault (N.C., always detected, alarm only)
						2E: External Fault (N.O., detected during run, alarm only)	2E: External Fault (N.O., detected during run, alarm only)
						2F: External Fault (N.C., detected during run, alarm only)	2F: External Fault (N.C., detected during run, alarm only)
						30: PID integral reset	30: PID integral reset
						31: PID integral hold	31: PID integral hold
						32: Multi-step speed reference 4	32: Multi-step speed reference 4
						34: PID Soft Starter cancel	34: PID Soft Starter cancel
						35: PID input (error) polarity switch	35: PID input level selection
	—	40: Forward run command					
	—	41: Reverse run command					
	—	42: Run command					
	—	43: Forward/Reverse command 2					
	Terminal S7 Function Selection	H1-05	6 (4)	H1-07	6 (4)	—	44: Offset frequency 1
						—	45: Offset frequency 2
						—	46: Off-set frequency 3
						—	47: Node setup
						60: DC Injection Braking	60: DC Injection Braking
						61: Speed search 1	61: Speed search 1
						62: Speed search 2	62: Speed search 2
	Terminal S7 Function Selection	H1-05	6 (4)	H1-07	6 (4)	63: Magnetic field weakening	63: Magnetic field weakening
						64: Speed search 3	64: Speed search 3
						65: KEB Ride-thru (N.C.)	65: KEB Ride-thru (N.C.)
						66: KEB Ride-thru (N.O.)	66: KEB Ride-thru (N.O.)
						67: Comm. test mode	67: Comm. test mode
						68: High Slip Braking	68: High Slip Braking
69: Jog 2						—	
Multi-Function Relay Input	Terminal S8 Function Selection	H1-06	8 (6)	H1-08	8	6A: Drive Enable	6A: Drive enable
						71: Speed/Torque Control selection	71: Speed/Torque Control switch
						72: Zero Servo	72: Zero Servo
						—	75: UP 2
						—	76: DOWN 2
						77: ASR gain switch	77: ASR gain switch
						78: Polarity Reversing Command for External Torque Control	78: External torque ref, polarity inversion
						—	7A: KEB Ride-Thru 2 (N.C.)
						—	7B: KEB Ride-Thru 2 (N.O.)
						—	7C: Short Braking command (N.O.)
						—	7D: Short Braking command (N.C.)
						—	7E: Forward/reverse Detection
						—	90 to 97: DriveWorksEZ 1 to 8
—	9F: DriveWorksEZ disable						

## 10 Appendix 2 Parameter Cross Reference

Parameter Name		F7		A1000		Setting	
		Parameter	Default	Parameter	Default	F7	A1000
Multi-Function Relay Output	Terminal M1 and M2 Function Selection	H2-01	0	H2-01	0	H2-01 to H2-03	H2-01 to H2-03
						0: During Run 1	0: During run
						1: Zero Speed	1: Zero speed
						2: Fref/Fout Agree 1	2: Speed agree 1
						3: Fref/Set agree 1	3: User-set speed agree 1
						4: Frequency detection 1	4: Frequency detection 1
						5: Frequency detection 2 (used when L4-07=1)	5: Frequency detection 2 (used when L4-07=1)
						6: Drive ready	6: Drive ready
						7: DC bus undervoltage	7: DC bus undervoltage
						8: Baseblock 1 (N.O.)	8: During Baseblock (N.O.)
						9: Option reference	9: Freq ref source
						A: Local/Remote operation	A: Run cmd source
						B: Torque detection 1 (N.O.)	B: Torque detection 1 (N.O.)
						C: Frequency reference loss	C: Frequency reference loss
						D: Braking resistor overheat	D: Braking resistor overheat
E: Fault	E: Fault						
F: Not used	F: Through-mode						
10: Minor Fault - Alarm	10: Minor Fault - Alarm						
11: Reset command active	11: Fault reset command active						

## 10 Appendix 2 Parameter Cross Reference

Parameter Name		F7		A1000		Setting	
		Parameter	Default	Parameter	Default	F7	A1000
Multi-Function Relay Output	Terminal M3-M4 Function Selection	H2-02	1	H2-02	1	12: Timer output	12: Timer output
						13: Fref/Fout agree 2	13: Speed agree 2
						14: Fref/Fout agree 2	14: User-Set speed agree 2
						15: Frequency detection 3	15: Frequency detection 3
						16: Frequency detection 4	16: Frequency detection 4
						17: Torque detection 1 (N.C.)	17: Torque detection 1 (N.C.)
						18: Torque detection 2 (N.O.)	18: Torque detection 2 (N.O.)
						19: Torque detection 2 (N.C.)	19: Torque detection 2 (N.C.)
						1A: Reverse run	1A: During reverse
						1B: During baseblock 2 (N.C.)	1B: During baseblock (N.C.)
	1C: Motor 2 selection	1C: Motor 2 selection					
	1D: Regenerating	1D: During Regeneration					
	1E: Fault restart enabled	1E: Fault restart enabled					
	1F: Motor overload alarm	1F: Motor overload alarm					
	20: Drive overheat prealarm	20: Drive overheat prealarm					
	—	22: Mechanical weakening detection					
	—	2F: Maintenance period					
	30: During torque limit	30: During torque limit					
	31: During speed limit	31: During speed limit					
	Terminal M5-M6 Function Selection	H2-03	2	H2-03	2	32: During Speed limit in Torque Control	32: During Speed limit in Torque Control
33: Zero servo complete						33: Zero servo complete	
37: During run 2						37: During frequency output	
38: Drive Enable						38: Drive enabled	
—						39: Watt hour pulse output	
—						3C: Local/Remote mode	
—						3D: During Speed Search	
—						3E: PID feedback low (during loss )	
—						3F: PID feedback high (fault)	
—						4A: During KEB Ride-thru	
—	4B: During Short Circuit Braking						
—	4C: During Fast Stop						
—	4D: oH pre-alarm time limit						
—	4E: Braking transistor fault (rr)						
—	4F: Braking resistor overheat (oH)						
—	60:: C ooling fan alarm						
—	61: Rotor position detection complete						
Multi-Function Relay Output	Terminal M5-M6 Function Selection	H2-03	2	H2-03	2	—	90 to 92: DriveWorksEZ, outputs 1-3
						—	100 to 192: Inverse Output of 0-92

## 10 Appendix 2 Parameter Cross Reference

Parameter Name		F7		A1000		Setting	
		Parameter	Default	Parameter	Default	F7	A1000
Analog Input	Terminal A1 Signal Level Selection	H3-01	0	H3-01	0	Terminal A1 in A1000 is multi-functional.	
						H3-01	H3-01
						0: 0 to +10 V	0: 0 to +10 V (uses lower limit)
						1: -10 to 10 V	1: -10 to 10 V (no lower limit)
	Terminal A1 Function Selection	—	—	H3-02	0	For A1000, set H3-02 to 0.	
	Terminal A1 Gain Setting	H3-02	100.0%	H3-03	100.0 %	—	
				F2-02	100.0 %	Set this parameter when using an analog option card to determine the gain added to the analog reference.	
	Terminal A1 Bias Setting	H3-03	0.0%	H3-04	0.0 %	—	
				F2-03	0.0 %	Set this parameter when using an analog option card to determine the gain added to the analog reference.	
	Terminal A3 Signal Level Selection	H3-04	0	H3-05	0	H3-04	H3-05
						0: 0 to +10 V	0: 0 to +10 V (uses lower limit)
						1: -10 to 10 V	1: -10 to 10 V (no lower limit)
	Terminal A3 Function Selection	H3-05	2	H3-06	2	H3-05, H3-09	
						H3-06, H3-10	
						0: Terminal A1 bias	
						0: Frequency bias	
						1: Frequency reference gain	
						1: Frequency gain	
						2: Auxiliary freq ref 1	
						2: Auxiliary freq ref 1	
3: Auxiliary freq ref 2							
3: Auxiliary frequency reference 2							
4: Output voltage bias							
4: Output voltage bias							
5: Accel/decel time coefficient							
5: Accel/decel time gain							
6: DC Injection Braking current							
6: DC Injection Braking current							
7: Torque detection level							
7: Torque detection level							
8: Stall Prevention level during run							
8: Stall Prevention level during run							
9: Frequency Ref. lower limit							
9: Output freq lower limit level							
A: Jump frequency 4							
—							
B: PID feedback							
B: PID feedback							
C: PID setpoint							
C: PID setpoint							
D: Frequency Reference bias 2							
D: Frequency bias							
E: Motor temperature							
E: Motor temperature							
F: Through- mode							
F: Through- mode							

## 10 Appendix 2 Parameter Cross Reference

Parameter Name		F7		A1000		Setting	
		Parameter	Default	Parameter	Default	F7	A1000
Analog Input	Terminal A3 Function Selection	H3-05	2	H3-06	2	10: FWD torque limit	10: FWD torque limit
						11: REV torque limit	11: REV torque limit
						12: Torque limit during regen	12: Torque limit during regen
						13: Torque ref/Torque limit during Torque Control	13: Torque ref/Torque limit
						14: Torque compensation	14: Torque compensation
						15: Fwd/Rev torque limit	15: General torque limit
						—	16: Differential PID feedback
						1F: Not used	1F: Through-mode
	—	30 to 32: DriveWorksEZ, Analog input 1 to 3					
	Terminal A3 Gain Setting	H3-06	100.0 %	H3-07	100.0 %	—	
	Terminal A3 Bias Setting	H3-07	0.0 %	H3-08	0.0 %	—	
	Terminal A2 Signal Level Selection	H3-08	2	H3-09	2	H3-08	H3-09
						0: 0 to 10 V	0: 0 to +10 V (with lower limit)
1: -10 to 10 V						1: -10 to +10 V (no lower limit)	
2: 4 to 20 mA						2: 4 to 20 mA	
Terminal A2 Function Selection	H3-09	0*	H3-10	0*	*For A1000, see the description for H3-06.		
Terminal A2 Gain Setting	H3-10	100.0 %	H3-11	100.0 %	—		
Terminal A2 Bias Setting	H3-11	0.0 %	H3-12	0.0 %	—		
Analog Input Filter Time Constant	H3-12	0.03 s	H3-13	0.03 s	—		
Multi-Function Analog Output	Analog Output 1 Terminal FM Monitor Selection	H4-01	2*	H4-01	102*	*See the description for F4-01	
	Analog Output 1 Terminal FM Gain	H4-02	100 %	H4-02	100.0 %	—	
	Analog Output 1 Terminal FM Bias	H4-03	0.0 %	H4-03	0.0 %	—	
	Analog Output 2 Terminal AM Selection	H4-04	3*	H4-04	103*	*See the description for F4-01	
	Analog Output 2 Terminal AM Gain	H4-05	50.0 %	H4-05	50.0 %	—	
	Analog Output 2 Terminal AM Bias	H4-06	0.0 %	H4-06	0.0 %	—	
	Analog Output 1 Signal Level (FM) Selection	H4-07	0	H4-07	0	H4-07	H4-07
						0: 0 to +10 V output	0: 0 to +10 Vdc output
						1: -10 to 10 Vdc output	1: -10 to 10 Vdc output
	2: 4 to 20 mA	2: 4 to 20 mA					
	Analog Output 2 Signal Level (AM) Selection	H4-08	0	H4-08	0	H4-08	H4-08
0: 0 to +10 V output						0: 0 to +10 Vdc output	
1: -10 to 10 Vdc output						1: -10 to 10 Vdc output	
2: 4 to 20 mA	2: 4 to 20 mA						



## 10 Appendix 2 Parameter Cross Reference

Parameter Name		F7		A1000		Setting	
		Parameter	Default	Parameter	Default	F7	A1000
MEMOBUS Communication	Drive Node Address	H5-01	1F	H5-01	1F	—	
	Communication Speed Selection	H5-02	3	H5-02	3	H5-02	H5-02
						0: 1200 bps	0: 1200 bps
						1: 2400 bps	1: 2400 bps
						2: 4800 bps	2: 4800 bps
						3: 9600 bps	3: 9600 bps
						4: 19200 bps	4: 19200 bps
						—	5: 38400 bps
						—	6: 57600 bps
	Communication Parity Selection	H5-03	0	H5-03	0	H5-03	H5-03
						0: No parity	0: No parity
						1: Even parity	1: Even parity
	Stopping Method After Communication Error	H5-04	3	H5-04	0	H5-04	H5-04
						0: Ramp to stop	0: Ramp to stop
						1: Coast to stop	1: Coast to stop
						2: Fast Stop	2: Fast Stop
Communication Fault Detection Selection	H5-05	1	H5-05	0	H5-05	H5-05	
					0: Disabled	0: Disabled	
Drive Transmit Wait Time	H5-06	5 ms	H5-06	5 ms	—		
					—		
RTS Control Selection	H5-07	1	H5-07	1	H5-07	H5-07	
					0: Disabled (RTS always on)	0: Disabled (RTS always on)	
Unit Selection for MEMOBUS Register 0025H	H5-10	0	H5-10	0	H5-10	H5-10	
					0: 0.1 V units	0: 0.1 V units	
Pulse Train I/O	Pulse Train Input Function Selection	H6-01	0	H6-01	0	H6-01	H6-01
						0: Frequency reference	0: Frequency reference
						1: PID feedback value	1: PID feedback value
						2: PID setpoint value	2: PID setpoint value
						—	3: V/f Control with Simple PG feedback
Pulse Train I/O	Pulse Train Input Scaling	H6-02	1440 Hz	H6-02	1440 Hz	—	
	Pulse Train Input Gain	H6-03	100.0 %	H6-03	100.0 %	—	
	Pulse Train Input Bias	H6-04	0.0 %	H6-04	0.0 %	—	
	Pulse Train Input Filter Time	H6-05	0.10 s	H6-05	0.10 s	—	
	Pulse Train Monitor Selection	H6-06	2	H6-06	102	H6-06	H6-06
						01: Frequency reference	101: Frequency reference
						02: Output frequency	102: Output frequency
						05: Motor speed	105: Motor speed
20: Output frequency after soft start						116: Output frequency after soft start	
24: PID feedback	501: PID feedback						
36: PID input amount	502: PID input amount						
Pulse Train Monitor Scaling	H6-07	1440 Hz	H6-07	1440 Hz	—		

## 10 Appendix 2 Parameter Cross Reference

Parameter Name		F7		A1000		Setting	
		Parameter	Default	Parameter	Default	F7	A1000
Motor Protection Function	Motor Overload Protection Selection	L1-01	1	L1-01	1*	L1-01	L1-01
						0: Disabled	0: Disabled
						1: Standard fan cooled	1: General-purpose motor
						2: Standard blower cooled	2: Drive-dedicated motor with a speed range of 1:10
						3: Vector motor	3: Vector motor with a speed range of 1:100
						—	4: PM motor with variable torque
						—	5: PM motor with constant torque control
	—	6: General purpose motor (50 Hz)					
	Motor Overload Protection Time	L1-02	8.0 min.	L1-02	1.0 min.	—	
	Motor Overheat Alarm Operation Selection	L1-03	3	L1-03	3	L1-03	L1-03
0: Ramp to stop						0: Ramp to stop	
1: Coast to stop						1: Coast to stop	
2: Fast Stop						2: Fast Stop	
Motor Overheat Fault Operation Selection	L1-04	1	L1-04	1	L1-04	L1-04	
					0: Ramp to stop	0: Ramp to stop	
					1: Coast to stop	1: Coast to stop	
Motor Temperature Input Filter Time	L1-05	0.20 s	L1-05	0.20 s	—		
Momentary Power Loss Process	Momentary Power Loss Detection/Operation Selection	L2-01	0	L2-01	0	L2-01	L2-01
						0: Disabled	0: Disabled
						1: Power Loss Ride Thru Time	1: Recover within the time set in L2-02
						2: CPU Power Active	2: Recover as long as CPU Power Active
						—	3: KEB deceleration for time set in L2-02
	—	4: KEB deceleration as long as CPU has power.					
	—	5: KEB deceleration to stop.					
	Momentary Power Loss Ride-Thru Time	L2-02	*	L2-02	*	*Dependent on kVA and parameters C6-01 and o2-04	
	Momentary Power Loss Minimum Baseblock Time	L2-03	*	L2-03	*	*Dependent on kVA and parameters C6-01 and o2-04	
	Momentary Power Loss Voltage Recovery Ramp Time	L2-04	*	L2-04	*	*Dependent on kVA and parameters C6-01 and o2-04	
Undervoltage Detection Level	L2-05	190 V	L2-05	190 V	380 V for a 400 class drive. But if E1-01 is set lower than 400, then for set 350 V for A1000.		
KEB Deceleration Time	L2-06	0.0 s	L2-06	0.0 s	Sets the deceleration time during KEB.		
KEB Acceleration Time After Power Recovery	L2-07	0.0 s	L2-07	0.0 s	—		
Momentary Power Loss Process	Frequency Gain at KEB Start	L2-08	100 %	L2-08	100 %	—	

## 10 Appendix 2 Parameter Cross Reference

Parameter Name		F7		A1000		Setting	
		Parameter	Default	Parameter	Default	F7	A1000
Stall Prevention Function	Stall Prevention Selection during Acceleration	L3-01	1	L3-01	1	L3-01	L3-01
						0: Disabled	0: Disabled
						1: General purpose	1: General purpose
						2: Intelligent	2: Intelligent
	Stall Prevention Level during Acceleration	L3-02	*	L3-02	150 %**	*Varies by Duty Rating **Upper limit is determined by C6-01 and L8-38.	
	Stall Prevention Limit during Acceleration	L3-03	50 %	L3-03	50 %	—	
	Stall Prevention Selection during Deceleration	L3-04	1	L3-04	1	L3-04	L3-04
						0: Disabled	0: Disabled
						1: General purpose	1: General purpose
						2: Intelligent	2: Intelligent
						3: Stall Prevention with braking resistor	3: Stall Prevention with braking resistor
						—	4: Overexcitation Deceleration
	Stall Prevention Selection during Run	L3-05	1	L3-05	1	L3-05	L3-05
						0: Disabled	0: Disabled
1: Enabled (Decel Time 1)						1: Enabled (Decel Time 1)	
2: Enabled (Decel Time 2)						2: Enabled (Decel Time 2)	
Stall Prevention Level during Run	L3-06	*	L3-06	**	*Varies by duty rating (Defaults:HD = 150 %, ND = 120 %) **Upper limit is determined by C6-01 and L8-38.		
Overvoltage Suppression Function Selection	L3-11	0	L3-11	0	L3-11	L3-11	
					0: Disabled	0: Disabled	
					1: Enabled	1: Enabled	
Stall Prevention Function	F7: Overvoltage Suppression Voltage Level A1000: Target DC Bus Voltage for Overvoltage Suppression and Stall Prevention	L3-12	380 V*	L3-17	370 V*	*Double values for 400 V class drives.	
Frequency Detection	Speed Agreement Detection Level	L4-01	0.0 Hz	L4-01	0.0 Hz	—	
	Speed Agreement Detection Width	L4-02	2.0 Hz	L4-02	*	*Dependent on parameter A1-02	
	Speed Agreement Detection Level (+/-)	L4-03	0.0 Hz	L4-03	0.0 Hz	—	
	Speed Agreement Detection Width (+/-)	L4-04	2.0 Hz	L4-04	*	*Dependent on parameter A1-02	
	Frequency Reference Loss Detection Selection	L4-05	0	L4-05	0	L4-05	L4-05
						0: Stop	0: Stop
1: Run at L4-06 PrevRef						1: Run at the level set to L4-06	
In A1000, the setting range for the frequency reference when the reference is lost (L4-06) is 0 to 100 % (default: 80 %)							
Reference Detection	Frequency Reference Level at Loss Frequency	L4-06	80.0 %	L4-06	80.0 %	—	
Fault Restart	Number of Auto Restart Attempts	L5-01	0 times	L5-01	0 times	—	
	Auto Restart Operation Selection	L5-02	0	L5-02	0	L5-02	L5-02
						0: No Fault Relay	0: Fault output not active
1: Fault Relay Active						1: Fault output active during restart attempt	

## 10 Appendix 2 Parameter Cross Reference

Parameter Name		F7		A1000		Setting	
		Parameter	Default	Parameter	Default	F7	A1000
Overtorque Detection	Torque Detection Selection 1	L6-01	0	L6-01	0	L6-01, L6-04	L6-01, L6-04
						0: Disabled	0: Disabled
						1: oL3 detection only active during speed agree, operation continues after detection	1: oL3 detection only active during speed agree, operation continues after detection
						2: oL3 detection always active during run, operation continues after detection	2: oL3 detection always active during run, operation continues after detection
						3: oL3 detection only active during speed agree, output shuts down on an oL3 fault	3: oL3 detection only active during speed agree, output shuts down on an oL3 fault
						4: oL3 detection always active during run, output shuts down on an oL3 fault	4: oL3 detection always active during run, output shuts down on an oL3 fault
						5: UL3 detection only active during speed agree, operation continues after detection	5: UL3 detection only active during speed agree, operation continues after detection
						6: UL3 detection always active during run, operation continues after detection	6: UL3 detection always active during run, operation continues after detection
						7: UL3 detection only active during speed agree, output shuts down on an oL3 fault	7: UL3 detection only active during speed agree, output shuts down on an oL3 fault
						8: UL3 detection always active during run, output shuts down on an oL3 fault	8: UL3 detection always active during run, output shuts down on an oL3 fault
	Torque Detection Level 1	L6-02	150 %	L6-02	150 %	—	—
	Torque Detection Time 1	L6-03	0.1 s	L6-03	0.1 s	—	—
Overtorque Detection	Torque Detection Selection 2	L6-04	0*	L6-04	0*	*See the description for L6-01; replace “oL3” and “UL3” with “oL4” and “UL4”, respectively	
	Torque Detection Level 2	L6-05	150 %	L6-05	150 %	—	—
	Torque Detection Time 2	L6-06	0.1 s	L6-06	0.1 s	—	—
Torque Limit	Forward Torque Limit	L7-01	200 %	L7-01	200 %	—	—
	Reverse Torque Limit	L7-02	200 %	L7-02	200 %	—	—
	Forward Regenerative Torque Limit	L7-03	200 %	L7-03	200 %	—	—
	Reverse Regenerative Torque Limit	L7-04	200 %	L7-04	200 %	—	—
	Torque Limit Integral Time Constant	L7-06	200 ms	L7-06	200 ms	—	—
	Torque Limit Control Method Selection During Accel/Decel	L7-07	0	L7-07	0	L7-07	L7-07
0: Proportional Control (60 Hz VT2)	0: Proportional control						
1: Integral Control (50 Hz HST1)	1: Integral control						
Hardware Protection	Internal Dynamic Braking Resistor Protection Selection (ERF)	L8-01	0	L8-01	0	L8-01	L8-01
						0: Not Provided	0: Disabled
						1: Provided	1: Enabled
	Overheat Pre-Alarm Level	L8-02	95°C	L8-02	*	*Determined by parameters C6-01 and o2-04	

## 10 Appendix 2 Parameter Cross Reference

Parameter Name		F7		A1000		Setting	
		Parameter	Default	Parameter	Default	F7	A1000
Hardware Protection	Overheat Pre-Alarm Operation Selection	L8-03	3	L8-03	3	L8-03	L8-03
						0: Ramp to stop	0: Ramp to stop
						1: Coast to stop	1: Coast to stop
						2: Fast Stop	2: Fast Stop
						3: Alarm Only	3: Continue operation (Alarm triggered)
	—	4: Continue operation at reduced speed as set in L8-19					
	Input Phase Loss Protection Selection	L8-05	0	L8-05	1	L8-05	L8-05
						0: Disabled	0: Disabled
						1: Enabled	1: Enabled
	Output Open-Phase Protection Selection	L8-07	0	L8-07	1	L8-07	L8-07
						0: Disabled	0: Disabled
						1: Enabled (triggered by a single phase loss)	1: Enabled (triggered by a single phase loss)
						2: Enabled (triggered when two phases are lost)	2: Enabled (triggered when two phases are lost)
	Output Ground Fault Detection Selection	L8-09	1	L8-09	1*	L8-09	L8-09
						0: Disabled	0: Disabled
1: Enabled						1: Enabled	
*Determined by parameters C6-01 and o2-04							
Heatsink Cooling Fan Operation Selection	L8-10	0	L8-10	0	L8-10	L8-10	
					0: During run only	0: During run only	
					1: Fan always on	1: Fan always on	
Heatsink Cooling Fan Operation Delay Time	L8-11	60 s	L8-11	60 s	—		
Ambient Temperature Setting	L8-12	45°C	L8-12	40°C	Set the ambient temperature where the drive is being used.		
oL2 Characteristics Selection at Low Speeds	L8-15	1	L8-15	1	L8-15	L8-15	
					0: Disabled	0: Disabled	
					1: Enabled	1: Enabled	
Soft CLA Selection	L8-18	1	L8-18	1	L8-18	L8-18	
					0: Disabled	0: Disabled	
					1: Enabled	1: Enabled	
Hunting Prevention Function	n1-01	1	n1-01	1	n1-01	n1-01	
					0: Disabled	0: Disabled	
					1: Enabled	1: Enabled	
Hunting Prevention Gain Setting	n1-02	1.00	n1-02	1.00	—		
Speed Feedback Detection Control Function	Speed Feedback Detection Control (AFR) Gain	n2-01	1.00	n2-01	1.00	—	
	Speed Feedback Detection Control (AFR) Time Constant	n2-02	50 ms	n2-02	50 ms	—	
	Speed Feedback Detection Control (AFR) Time Constant 2	n2-03	750 ms	n2-03	750 ms	—	
High slip Braking	High-Slip Braking Deceleration Frequency Width	n3-01	5 %	n3-01	5 %	—	
	High-Slip Braking Current Limit	n3-02	150 %	n3-02	150 %*	*Upper limit is determined by L8-38 and C6-01	
	High-Slip Braking Dwell Time at Stop	n3-03	1.0 s	n3-03	1.0 s	—	
	High-Slip Braking Overload Time	n3-04	40 s	n3-04	40 s	—	
Feed Forward Control	Feed Forward Control Selection	—	—	n5-01	0	New for the A1000.	
	Motor Acceleration Time	---	—	n5-02	*	*Determined by C6-01, o2-04, and E5-01. New for the A1000.	
	Feed Forward Control Ratio Gain	—	—	n5-03	1.00	New for the A1000.	

## 10 Appendix 2 Parameter Cross Reference

Parameter Name		F7		A1000		Setting			
		Parameter	Default	Parameter	Default	F7	A1000		
Display Setting/ Selection	Drive Mode Unit Monitor Selection	o1-01	6*	o1-01	106*	*See the comments given for parameter F4-01.			
	User Monitor Selection After Power Up	o1-02	1	o1-02	1	o1-02	o1-02		
						1: Frequency reference	1: Frequency reference		
						2: Output frequency	3: Output frequency		
						3: Output current	4: Output current		
						4: User-selected Monitor (set by o1-01)	5: User-selected Monitor (set by o1-01)		
	—	2: Direction							
	Digital Operator Display Selection	o1-03	0	o1-03	*	o1-03	o1-03		
						0: Hz units	0: 0.01 Hz units		
						1: % units (100 % = E1-04)	1: 0.01 % units		
						2 to 39: RPM	2: r/min units		
						40 to 39999: User display	3: User-set units		
							o1-10	o1-11	
						1 to 60000	0 to 3		
						o1-10: Determines how the units for the frequency reference.			
						o1-11: Sets the decimal point for the frequency reference display			
						*Determined by parameter A1-02			
Ex. : For a max output frequency of 200.0, set the following:									
Setting value : o1-03=12000	Setting value: o1-03=3 : o1-10=2000 : o1-11=1								
$\overline{12000}$ $\lfloor$ Max value, excluding decimal point → o1-10= "2000" $\lfloor$ digits displayed to the right of the decimal → o1-11= 1									
Setting Unit for Frequency Parameters Related to V/f Characteristics	o1-04	0	o1-04	*	o1-04	o1-04			
LCD Brightness	o1-05	3	—	—	—	This parameter is not available in A1000.			
						0: Hz units	0: Hz units		
						1: r/min units	1: r/min units		
						*Determined by A1-02			

## 10 Appendix 2 Parameter Cross Reference











Parameter Name		F7		A1000		Setting	
		Parameter	Default	Parameter	Default	F7	A1000
Multi-Function Selection	LOCAL/REMOTE Key Function Selection	o2-01	1	o2-01	1	o2-01	o2-01
						0: Disabled	0: Disabled
						1: Enabled	1: Enabled
	STOP Key Function Selection	o2-02	1	o2-02	1	o2-02	o2-02
						0: Disabled	0: Disabled
						1: Enabled	1: Enabled
	User Parameter Default Value	o2-03	0	o2-03	0	o2-03	o2-03
						0: No change	0: No change
						1: Set defaults	1: Save values
	Drive Model Selection	o2-04	*	o2-04	*	Do not change this setting. Varies by kVA Determined by drive capacity.	
						2: Clear all	2: Clear all
	Frequency Reference Setting Method Selection	o2-05	0	o2-05	0	o2-05	o2-05
						0: ENTER required	0: ENTER required
1: ENTER key not required						1: ENTER key not required	
Operation Selection when Digital Operator is Disconnected	o2-06	0	o2-06	1	o2-06	o2-06	
					0: Disabled	0: Continues operation if digital operator is disconnected	
					1: Enabled	1: An oPr fault is triggered and the motor coasts to a stop	
Cumulative Operation Time Setting	o2-07	0	o4-01	0 h	—		
Cumulative Operation Time Selection	o2-08	0	o4-02	0	o2-08	o4-02	
					0: Power on time	0: Logs power-on time	
					1: Running time	1: Logs operation time when the drive output is active	
Initialization Specification Selection	o2-09	1	o2-09	*	*Do not change this setting. Factory use only		
Fan Operation Time (A1000: Cooling Fan Operation Time Setting)	o2-10	0	o4-03	0 h	F7 Setting Range : 0 to 65535 A1000 Setting Range : 0 to 9999		
Multi-Function Selection	Fault Trace/Fault History Clear Function (A1000: U2, U3 Initialization)	o2-12	0	o4-11	0	o2-12	o4-11
						0: No change	0: No change
						1: Reset U2, U3 parameters	1: Reset U2, U3 parameters
kWh User Monitor Initialization	o2-14	0	o4-12	0	o2-14	o4-12	
					0: No change	0: No change	
					1: U1-29 and o2-14 are reset to zero	1: U4-10 and U4-11 are reset	
Copy Function	Copy Function Selection	o3-01	0	o3-01	0	o3-01	o3-01
						0: COPY SELECT	0: No action
						1: READ	1: Read LCD operation
						2: COPY	2: Write to the drive
						3: VERIFY	3: Verify
	Copy Allowed Selection	o3-02	0	o3-02	0	o3-02	o3-02
						0: Read prohibited	0: Read prohibited
1: Read allowed						1: Read allowed	

# 11 Appendix 3 Terminal Size and Wire Gauge

## ◆ Terminal Size and Wire Gauge









The table below lists the wiring sizes based on national electrical codes. Gauges are recommended, and users may select different gauges at their own discretion. For wire gauges applicable in the United States refer to "Chapter 3. Electrical Installation" of the A1000 Quick Start Guide (TOEPC71061641).

**Table 19 3-Phase 240 V Class Main Circuit Terminal Size and Wire Gauge**



Series	Model	Terminal Signal	Terminal Screw	Tightening Torque N · m (lb.in.)	Wire Range AWG, kcmil	Recommended Gauge AWG, kcmil
F7	20P4 20P7	R/L1, S/L2, T/L3, U/T1, V/T2, W/T3, -, +1, +2, B1, B2, 	M4	1.2 to 1.5 (10.6 to 13.3)	14 to 10	14
A1000	2A0004 2A0006	R/L1, S/L2, T/L3, U/T1, V/T2, W/T3, -, +1, +2, B1, B2, 	M4	1.2 to 1.5 (10.6 to 13.3)	14 to 10	14, 10 (Ground)
F7	21P5	R/L1, S/L2, T/L3, U/T1, V/T2, W/T3, -, +1, +2, B1, B2, 	M4	1.2 to 1.5 (10.6 to 13.3)	14 to 10	14
A1000	2A0008 2A0010	R/L1, S/L2, T/L3, U/T1, V/T2, W/T3, -, +1, +2, B1, B2, 	M4	1.2 to 1.5 (10.6 to 13.3)	14 to 10	14, 10 (Ground)
F7	22P2	R/L1, S/L2, T/L3, U/T1, V/T2, W/T3, -, +1, +2, B1, B2, 	M4	1.2 to 1.5 (10.6 to 13.3)	14 to 10	14
A1000	2A0012	R/L1, S/L2, T/L3, U/T1, V/T2, W/T3, -, +1, +2, B1, B2, 	M4	1.2 to 1.5 (10.6 to 13.3)	14 to 10	10 (L1-L3), 14
			M4	1.2 to 1.5 (10.6 to 13.3)	14 to 10	10
F7	23P7	R/L1, S/L2, T/L3, U/T1, V/T2, W/T3, -, +1, +2, B1, B2, 	M4	1.2 to 1.5 (10.6 to 13.3)	12 to 10	12
A1000	2A0018 2A0021	R/L1, S/L2, T/L3, -, +1, +2	M4	1.2 to 1.5 (10.6 to 13.3)	12 to 10	10
		U/T1, V/T2, W/T3, 	M4	1.2 to 1.5 (10.6 to 13.3)	12 to 10	10
		B1, B2	M4	1.2 to 1.5 (10.6 to 13.3)	14 to 10	—
F7	25P5	R/L1, S/L2, T/L3, U/T1, V/T2, W/T3, -, +1, +2, B1, B2, 	M4	1.2 to 1.5 (10.6 to 13.3)	10	10
A1000	2A0030	R/L1, S/L2, T/L3, -, +1, +2	M4	1.2 to 1.5 (10.6 to 13.3)	10 to 6	8
		U/T1, V/T2, W/T3	M4	1.2 to 1.5 (10.6 to 13.3)	10 to 6	8
		B1, B2	M4	1.2 to 1.5 (10.6 to 13.3)	14 to 10	—
			M5	2 to 2.5 (17.7 to 22.1)	10 to 8	8
F7	27P5	R/L1, S/L2, T/L3, U/T1, V/T2, W/T3, -, +1, +2, B1, B2, 	M5	2.5 (21.99)	8 to 6	8







## 11 Appendix 3 Terminal Size and Wire Gauge

Series	Model	Terminal Signal	Terminal Screw	Tightening Torque N · m (lb.in.)	Wire Range AWG, kcmil	Recommended Gauge AWG, kcmil
A1000	2A0040	R/L1, S/L2, T/L3, -, +1, +2	M4	1.2 to 1.5 (10.6 to 13.3)	8 to 6	6
		U/T1, V/T2, W/T3	M4	1.2 to 1.5 (10.6 to 13.3)	8 to 6	8
		B1, B2	M4	1.2 to 1.5 (10.6 to 13.3)	12 to 10	—
			M5	2 to 2.5 (17.7 to 22.1)	10 to 8	8
F7	2011	R/L1, S/L2, T/L3, U/T1, V/T2, W/T3, -, +1, +2, B1, B2, 	M5	2.5 (21.99)	6 to 4	4, 6 (Ground and T1-3)
A1000	2A0056	R/L1, S/L2, T/L3, -, +1, +2	M6	4 to 6 (35.4 to 53.1)	6 to 4	4
		U/T1, V/T2, W/T3	M6	4 to 6 (35.4 to 53.1)	6 to 4	4
		B1, B2	M5	2 to 2.5 (17.7 to 22.1)	10 to 6	—
			M6	4 to 6 (35.4 to 53.1)	8 to 6	6
F7	2015	R/L1, S/L2, T/L3, U/T1, V/T2, W/T3, -, +1, +2	M6	4 to 5 (35.2 to 43.99)	4 to 2	3, 4 (T1-3)
		B1, B2	M5	2.5 (21.99)	8 to 6	—
			M6	4 to 5 (35.2 to 43.99)	4	4
A1000	2A0069	R/L1, S/L2, T/L3, -, +1, +2	M8	9 to 11 (79.7 to 97.4)	4 to 3	3
		U/T1, V/T2, W/T3,	M8	9 to 11 (79.7 to 97.4)	4 to 3	3
		B1, B2	M5	2 to 2.5 (17.7 to 22.1)	8 to 6	—
			M6	4 to 6 (35.4 to 53.1)	6 to 4	6
F7	2018	R/L1, S/L2, T/L3, U/T1, V/T2, W/T3, -, +1, +2	M8	9 to 10 (79.2 to 87.97)	3 to 2	2, 3 (T1-3)
		B1, B2	M5	2.5 (21.99)	8 to 6	—
			M6	4 to 5 (35.2 to 43.99)	4	4
A1000	2A0081	R/L1, S/L2, T/L3, -, +1, +2	M8	9 to 11 (79.7 to 97.4)	3 to 2	2
		U/T1, V/T2, W/T3	M8	9 to 11 (79.7 to 97.4)	3 to 2	2
		B1, B2	M5	2 to 2.5 (17.7 to 22.1)	6	—
			M6	4 to 6 (35.4 to 53.1)	6 to 4	6
F7	2022	R/L1, S/L2, T/L3, U/T1, V/T2, W/T3, -, +1, R1/L11, S1/L21, T1/L31	M8	9 to 10 (79.2 to 87.97)	N/A	1, 2 (T1-3)
		+3	M6	4 to 5 (35.2 to 43.99)	N/A	—
			M8	9 to 10 (79.2 to 87.97)	N/A	4



## 11 Appendix 3 Terminal Size and Wire Gauge

Series	Model	Terminal Signal	Terminal Screw	Tightening Torque N · m (lb.in.)	Wire Range AWG, kcmil	Recommended Gauge AWG, kcmil
A1000	2A0110	R/L1, S/L2, T/L3, U/T1, V/T2, W/T3	M8	9 to 11 (79.7 to 97.4)	3 to 1/0	1/0
		-, +1	M8	9 to 11 (79.7 to 97.4)	2 to 1/0	—
		B1, B2	M8	9 to 11 (79.7 to 97.4)	6 to 1/0	—
			M8	9 to 11 (79.7 to 97.4)	6 to 4	6
F7	2030	R/L1, S/L2, T/L3, U/T1, V/T2, W/T3, -, +1, R1/L11, S1/L21, T1/L31	M8	9 to 10 (79.2 to 87.97)	N/A	1/0
		+3	M6	4 to 5 (35.2 to 43.99)	N/A	—
			M8	9 to 10 (79.2 to 87.97)	N/A	4
A1000	2A0138	R/L1, S/L2, T/L3, U/T1, V/T2, W/T3	M10	18 to 23 (159 to 204)	1 to 2/0	2/0
		-, +1	M10	18 to 23 (159 to 204)	1/0 to 3/0	—
		B1, B2	M10	18 to 23 (159 to 204)	4 to 2/0	—
			M8	9 to 11 (79.7 to 97.4)	4	4
F7	2037	R/L1, S/L2, T/L3, U/T1, V/T2, W/T3, -, +1, R1/L11, S1/L21, T1/L31	M10	17.6 to 22.5 (154.8 to 197.9)	N/A	4/0
		+3	M8	8.8 to 10.8 (77.4 to 95.0)	N/A	—
			M10	17.6 to 22.5 (154.8 to 197.9)	N/A	2
		$r/\ell 1, \Delta/\ell 2$	M4	1.3 to 1.4 (11.4 to 12.3)	N/A	16
A1000	2A0169	R/L1, S/L2, T/L3, U/T1, V/T2, W/T3	M10	18 to 23 (159 to 204)	2/0 to 4/0, 3/0 to 4/0 (T1-3)	4/0
		-, +1	M10	18 to 23 (159 to 204)	1 to 4/0	—
		+3	M10	18 to 23 (159 to 204)	1/0 to 4/0	—
			M10	18 to 23 (159 to 204)	4 to 2	4
F7	2045	R/L1, S/L2, T/L3, U/T1, V/T2, W/T3, -, +1, R1/L11, S1/L21, T1/L31	M10	17.6 to 22.5 (154.8 to 197.9)	N/A	300, 250 (T1-3)
		+3	M8	8.8 to 10.8 (77.4 to 95.0)	N/A	—
			M10	17.6 to 22.5 (154.8 to 197.9)	N/A	1
		$r/\ell 1, \Delta/\ell 2$	M4	1.3 to 1.4 (11.4 to 12.3)	N/A	16





## 11 Appendix 3 Terminal Size and Wire Gauge

Series	Model	Terminal Signal	Terminal Screw	Tightening Torque N · m (lb.in.)	Wire Range AWG, kcmil	Recommended Gauge AWG, kcmil
A1000	2A0211	R/L1, S/L2, T/L3	M10	18 to 23 (159 to 204)	1/0 to 2/0	1/0×2P
		U/T1, V/T2, W/T3	M10	18 to 23 (159 to 204)	1/0 to 2/0	1/0×2P
		-, +1	M10	18 to 23 (159 to 204)	1 to 4/0	—
		+3	M10	18 to 23 (159 to 204)	1/0 to 4/0	—
			M10	18 to 23 (159 to 204)	4 to 1/0	4
F7	2055	R/L1, S/L2, T/L3, -, +1	M10	17.6 to 22.5 (154.8 to 197.9)	N/A	1/0×2P
		U/T1, V/T2, W/T3, R1/L11, S1/L21, T1/L31	M10	17.6 to 22.5 (154.8 to 197.9)	N/A	1/0×2P
		+3	M8	8.8 to 10.8 (77.4 to 95.0)	N/A	—
			M10	17.6 to 22.5 (154.8 to 197.9)	N/A	1/0
		$r/\bar{r}1, \bar{a}/\bar{a}2$	M4	1.3 to 1.4 (11.4 to 12.3)	N/A	16
A1000	2A0250	R/L1, S/L2, T/L3	M12	32 to 40 (283 to 354)	3/0 to 300	3/0×2P
		U/T1, V/T2, W/T3	M12	32 to 40 (283 to 354)	3/0 to 300	3/0×2P
		-, +1	M12	32 to 40 (283 to 354)	3/0 to 300	—
		+3	M10	18 to 23 (159 to 204)	2 to 300	—
			M12	32 to 40 (283 to 354)	3 to 300	3
F7	2075	-, +1	M12	31.4 to 39.2 (276.2 to 344.8)	N/A	3/0×2P
		R/L1, S/L2, T/L3, U/T1, V/T2, W/T3, R1/L11, S1/L21, T1/L31	M10	17.6 to 22.5 (154.8 to 197.9)	N/A	4/0×2P, 3/0×2P (T1-3)
		+3	M8	8.8 to 10.8 (77.4 to 95.0)	N/A	—
			M12	31.4 to 39.2 (276.2 to 344.8)	N/A	3/0
		$r/\bar{r}1, \bar{a}/\bar{a}2$	M4	1.3 to 1.4 (11.4 to 12.3)	N/A	16
A1000	2A0312	R/L1, S/L2, T/L3	M12	32 to 40 (283 to 354)	3/0 to 300	4/0×2P
		U/T1, V/T2, W/T3	M12	32 to 40 (283 to 354)	3/0 to 300	3/0×2P
		-, +1	M12	32 to 40 (283 to 354)	3/0 to 300	—
		+3	M10	18 to 23 (159 to 204)	3/0 to 300	—
			M12	32 to 40 (283 to 354)	2 to 300	2
F7	2090	R/L1, S/L2, T/L3, -, +1, R1/L11, S1/L21, T1/L31	M12	31.4 to 39.2 (276.2 to 344.8)	N/A	250×2P
		U/T1, V/T2, W/T3	M12	31.4 to 39.2 (276.2 to 344.8)	N/A	4/0×2P
		+3	M8	8.8 to 10.8 (77.4 to 95.0)	N/A	—
			M12	31.4 to 39.2 (276.2 to 344.8)	N/A	2/0×2P
		$r/\bar{r}1, \bar{a}/\bar{a}2$	M4	1.3 to 1.4 (11.4 to 12.3)	N/A	16









## 11 Appendix 3 Terminal Size and Wire Gauge

Series	Model	Terminal Signal	Terminal Screw	Tightening Torque N · m (lb.in.)	Wire Range AWG, kcmil	Recommended Gauge AWG, kcmil
A1000	2A0360	R/L1, S/L2, T/L3	M12	32 to 40 (283 to 354)	4/0 to 600	250×2P
		U/T1, V/T2, W/T3	M12	32 to 40 (283 to 354)	4/0 to 600	4/0×2P
		-, +1	M12	32 to 40 (283 to 354)	250 to 600	—
		+3	M10	18 to 23 (159 to 204)	3/0 to 600	—
			M12	32 to 40 (283 to 354)	1 to 350	1
F7	2110	R/L1, S/L2, T/L3, -, +1, R1/L11, S1/L21, T1/L31	M12	31.4 to 39.2 (276.2 to 344.8)	N/A	350×2P
		U/T1, V/T2, W/T3	M12	31.4 to 39.2 (276.2 to 344.8)	N/A	300×2P
		+3	M8	8.8 to 10.8 (77.4 to 95.0)	N/A	—
			M12	31.4 to 39.2 (276.2 to 344.8)	N/A	300×2P
		R/L1, S/L2	M4	1.3 to 1.4 (11.4 to 12.3)	N/A	16
A1000	2A0415	R/L1, S/L2, T/L3	M12	32 to 40 (283 to 354)	250 to 600	350×2P
		U/T1, V/T2, W/T3	M12	32 to 40 (283 to 354)	300 to 600	300×2P
		-, +1	M12	32 to 40 (283 to 354)	300 to 600	—
		+3	M10	18 to 23 (159 to 204)	3/0 to 600	—
			M12	32 to 40 (283 to 354)	1 to 350	1









**Table 20 3-Phase 400 V Class Main Circuit Terminal Size and Gauge**

Series	Model	Terminal Signal	Terminal Screw	Tightening Torque N · m (lb.in.)	Wire Range AWG, kcmil	Recommended Gauge AWG, kcmil
F7	40P4 40P7	R/L1, S/L2, T/L3, U/T1, V/T2, W/T3, -, +1, +2, B1, B2, 	M4	1.2 to 1.5 (10.6 to 13.2)	14 to 10	14
A1000	4A0002 4A0004	R/L1, S/L2, T/L3, U/T1, V/T2, W/T3, -, +1, +2, B1, B2, 	M4	1.2 to 1.5 (10.6 to 13.2)	14 to 10	14, 12 (Ground)
F7	41P5 42P2	R/L1, S/L2, T/L3, U/T1, V/T2, W/T3, -, +1, +2, B1, B2, 	M4	1.2 to 1.5 (10.6 to 13.2)	14 to 10	14
A1000	4A0005 4A0007 4A0009	R/L1, S/L2, T/L3, U/T1, V/T2, W/T3, -, +1, +2, B1, B2	M4	1.2 to 1.5 (10.6 to 13.2)	14 to 10	14
			M4	1.2 to 1.5 (10.6 to 13.2)	14 to 10	10
F7	43P7	R/L1, S/L2, T/L3, U/T1, V/T2, W/T3, -, +1, +2, B1, B2	M4	1.2 to 1.5 (10.6 to 13.2)	14 to 10	12
			M4	1.2 to 1.5 (10.6 to 13.2)	14 to 10	14







## 11 Appendix 3 Terminal Size and Wire Gauge

Series	Model	Terminal Signal	Terminal Screw	Tightening Torque N · m (lb.in.)	Wire Range AWG, kcmil	Recommended Gauge AWG, kcmil
A1000	4A0011	R/L1, S/L2, T/L3, U/T1, V/T2, W/T3, -, +1, +2, B1, B2	M4	1.2 to 1.5 (10.6 to 13.2)	14 to 10	12, 14 (T1-3)
			M4	1.2 to 1.5 (10.6 to 13.2)	14 to 10	10
F7	45P5	R/L1, S/L2, T/L3, U/T1, V/T2, W/T3, -, +1, +2, B1, B2	M4	1.2 to 1.5 (10.6 to 13.2)	12 to 10	12
			M4	1.2 to 1.5 (10.6 to 13.2)	14 to 10	14
A1000	4A0018	R/L1, S/L2, T/L3, U/T1, V/T2, W/T3, -, +1, +2	M4	1.2 to 1.5 (10.6 to 13.2)	12 to 6	10
		B1, B2	M4	1.2 to 1.5 (10.6 to 13.2)	12 to 6	—
			M5	2 to 2.5 (17.7 to 22.1)	14 to 10	10
F7	47P5	R/L1, S/L2, T/L3, U/T1, V/T2, W/T3, -, +1, +2, B1, B2	M4	1.8 (15.6)	10	10
			M4	1.8 (15.6)	12 to 10	12
A1000	4A0023	R/L1, S/L2, T/L3, U/T1, V/T2, W/T3, -, +1, +2	M4	1.2 to 1.5 (10.6 to 13.3)	10 to 6, 12 to 6 (-, +1, +2)	10
		B1, B2	M4	1.2 to 1.5 (10.6 to 13.3)	12 to 10	—
			M5	2 to 2.5 (17.7 to 22.1)	12 to 10	10
F7	4011	R/L1, S/L2, T/L3, U/T1, V/T2, W/T3, -, +1, +2, B1, B2	M5	2.5 (21.99)	10 to 6	8
			M5	2.5 (21.99)	10 to 6	10
A1000	4A0031	R/L1, S/L2, T/L3, -, +1, +2	M5	2 to 2.5 (17.7 to 22.1)	8 to 6, 10 to 6 (-, +1, +2)	8
		U/T1, V/T2, W/T3	M5	2 to 2.5 (17.7 to 22.1)	10 to 6	8
		B1, B2	M5	2 to 2.5 (17.7 to 22.1)	10 to 8	—
			M6	4 to 6 (35.4 to 53.1)	10 to 8	8
F7	4015	R/L1, S/L2, T/L3, U/T1, V/T2, W/T3, -, +1, +2, B1, B2	M5	2.5 (21.99)	8 to 6	8
			M5, M6	2.5 (21.99), 4.0 to 5.0 (35.2 to 43.99)	10 to 6	10
A1000	4A0038	R/L1, S/L2, T/L3, U/T1, V/T2, W/T3	M5	2 to 2.5 (17.7 to 22.1)	8 to 6	6, 8 (T1-3)
		-, +1, +2	M5	2 to 2.5 (17.7 to 22.1)	8 to 6	—
		B1, B2	M5	2 to 2.5 (17.7 to 22.1)	10 to 8	—
			M6	4 to 6 (35.4 to 53.1)	10 to 6	6





## 11 Appendix 3 Terminal Size and Wire Gauge

Series	Model	Terminal Signal	Terminal Screw	Tightening Torque N · m (lb.in.)	Wire Range AWG, kcmil	Recommended Gauge AWG, kcmil
F7	4018	R/L1, S/L2, T/L3, U/T1, V/T2, W/T3, -, +1, +2	M6	4 to 5 (35.2 to 43.99)	8 to 2	6, 8 (T1-3)
		B1, B2	M5	2.5 (21.99)	8	8
			M6	4 to 5 (35.2 to 43.99)	8 to 4	8
A1000	4A0044	R/L1, S/L2, T/L3, U/T1, V/T2, W/T3, -, +1, +2	M6	4 to 6 (35.4 to 53.1)	6 to 4	6
		B1, B2	M5	2 to 2.5 (17.7 to 22.1)	10 to 8	—
			M6	4 to 6 (35.4 to 53.1)	8 to 6	6
F7	4022	R/L1, S/L2, T/L3, U/T1, V/T2, W/T3, -, +1, +3, R1/L11, S1/L21, T1/L31	M6	4 to 5 (35.2 to 43.99)	N/A	4, 6 (T1-3)
			M8	9 to 10 (79.2 to 87.97)	N/A	6
A1000	4A0058	R/L1, S/L2, T/L3, U/T1, V/T2, W/T3	M8	9 to 11 (79.7 to 97.4)	6 to 4	4
		-, +1	M8	9 to 11 (79.7 to 97.4)	6 to 1	—
		B1, B2	M8	9 to 11 (79.7 to 97.4)	8 to 4	—
			M8	9 to 11 (79.7 to 97.4)	8 to 6	6
F7	4030	R/L1, S/L2, T/L3, U/T1, V/T2, W/T3, -, +1, +3, R1/L11, S1/L21, T1/L31	M6	4 to 5 (35.2 to 43.99)	N/A	3, 4 (T1-3)
			M8	9 to 10 (79.2 to 87.97)	N/A	4
A1000	4A0072	R/L1, S/L2, T/L3, U/T1, V/T2, W/T3	M8	9 to 11 (79.7 to 97.4)	4 to 3	3
		-, +1 B1, B2	M8	9 to 11 (79.7 to 97.4)	4 to 1, 6 to 3 (B1, B2)	—
			M8	9 to 11 (79.7 to 97.4)	6	6
F7	4037	R/L1, S/L2, T/L3, U/T1, V/T2, W/T3, -, +1, R1/L11, S1/L21, T1/L31	M8	9 to 10 (79.2 to 87.97)	N/A	2, 3 (T1-3)
		+3	M6	4 to 5 (35.2 to 43.99)	N/A	—
			M8	9 to 10 (79.2 to 87.97)	N/A	4
A1000	4A0088	R/L1, S/L2, T/L3, U/T1, V/T2, W/T3	M8	9 to 11 (79.7 to 97.4)	3 to 1/0	2
		-, +1	M8	9 to 11 (79.7 to 97.4)	3 to 1/0	—
		+3	M8	9 to 11 (79.7 to 97.4)	6 to 1/0	—
			M8	9 to 11 (79.7 to 97.4)	6 to 4	4

## 11 Appendix 3 Terminal Size and Wire Gauge





Series	Model	Terminal Signal	Terminal Screw	Tightening Torque N · m (lb.in.)	Wire Range AWG, kcmil	Recommended Gauge AWG, kcmil
F7	4045	R/L1, S/L2, T/L3, U/T1, V/T2, W/T3, -, +1, R1/L11, S1/L21, T1/L31	M8	9 to 10 (79.2 to 87.97)	N/A	1/0, 1 (T1-3)
		+3	M6	4 to 5 (35.2 to 43.99)	N/A	—
			M8	9 to 10 (79.7 to 87.97)	N/A	4
A1000	4A0103	R/L1, S/L2, T/L3, U/T1, V/T2, W/T3	M8	9 to 11 (79.7 to 97.4)	2 to 1/0	1/0, 1 (T1-3)
		-, +1	M8	9 to 11 (79.7 to 97.4)	3 to 1/0	—
		+3	M8	9 to 11 (79.7 to 97.4)	4 to 1/0	—
			M8	9 to 11 (79.7 to 97.4)	6 to 4	4
F7	4055	R/L1, S/L2, T/L3, U/T1, V/T2, W/T3, -, +1, R1/L11, S1/L21, T1/L31	M8	9 to 10 (79.2 to 87.97)	N/A	2/0
		+3	M6	4 to 5 (35.2 to 43.99)	N/A	—
			M8	9 to 10 (79.2 to 87.97)	N/A	4
A1000	4A0139	R/L1, S/L2, T/L3	M10	18 to 23 (159 to 204)	1/0 to 4/0	3/0
		U/T1, V/T2, W/T3	M10	18 to 23 (159 to 204)	1/0 to 4/0	2/0
		-, +1	M10	18 to 23 (159 to 204)	1/0 to 4/0	—
		+3	M10	18 to 23 (159 to 204)	3 to 4/0	—
			M10	18 to 23 (159 to 204)	4	4
F7	4075	R/L1, S/L2, T/L3, R1/L11, S1/L21, T1/L31, -, +1	M10	17.6 to 22.5 (154.8 to 197.5)	N/A	4/0
		U/T1, V/T2, W/T3	M10	17.6 to 22.5 (154.8 to 197.5)	N/A	3/0
		+3	M8	8.8 to 10.8 77.4 to 95.0)	N/A	—
			M10	17.6 to 22.5 (154.8 to 197.5)	N/A	2
		$\frac{r}{l} 1, \frac{200}{l} 200, \frac{400}{l} 400$	M4	1.3 to 1.4 (11.4 to 12.3)	N/A	16
A1000	4A0165	R/L1, S/L2, T/L3	M10	18 to 23 (159 to 204)	3/0 to 4/0	4/0
		U/T1, V/T2, W/T3	M10	18 to 23 (159 to 204)	3/0 to 4/0	4/0
		-, +1	M10	18 to 23 (159 to 204)	1 to 4/0	—
		+3	M10	18 to 23 (159 to 204)	1/0 to 4/0	—
			M10	18 to 23 (159 to 204)	4 to 2	4

## 11 Appendix 3 Terminal Size and Wire Gauge

Series	Model	Terminal Signal	Terminal Screw	Tightening Torque N · m (lb.in.)	Wire Range AWG, kcmil	Recommended Gauge AWG, kcmil
F7	4090	R/L1, S/L2, T/L3, -, +1, R1/L11, S1/L21, T1/L31	M10	17.6 to 22.5 (154.8 to 197.5)	N/A	250
		U/T1, V/T2, W/T3	M10	17.6 to 22.5 (154.8 to 197.5)	N/A	4/0
		+3	M8	8.8 to 10.8 (77.4 to 95.0)	N/A	—
			M10	17.6 to 22.5 (154.8 to 95.0)	N/A	1
		$\overline{r/\ell_1}, \overline{\Delta 200/}$ $\overline{\ell_2 200}, \overline{\Delta 400/}$ $\overline{\ell_2 400}$	M4	1.3 to 1.4 (11.4 to 12.3)	N/A	16
A1000	4A0208	R/L1, S/L2, T/L3	M10	18 to 23 (159 to 204)	2 to 300	300
		U/T1, V/T2, W/T3	M10	18 to 23 (159 to 204)	2 to 300	300
		-, +1	M10	18 to 23 (159 to 204)	1 to 250	—
		+3	M10	18 to 23 (159 to 204)	3 to 3/0	—
			M10	18 to 23 (159 to 204)	4 to 300	4
F7	4110	R/L1, S/L2, T/L3, -, +1, R1/L11, S1/L21, T1/L31	M10	17.6 to 22.5 (154.8 to 197.5)	N/A	2/0×2P
		U/T1, V/T2, W/T3,	M10	17.6 to 22.5 (154.8 to 197.5)	N/A	1/0×2P
		+3	M8	8.8 to 10.8 (77.4 to 95.0)	N/A	—
			M12	31.4 to 39.2 (276.2 to 344.8)	N/A	2/0
		$\overline{r/\ell_1}, \overline{\Delta 200/}$ $\overline{\ell_2 200}, \overline{\Delta 400/}$ $\overline{\ell_2 400}$	M4	1.3 to 1.4 (11.4 to 12.3)	N/A	16
A1000	4A0250	R/L1, S/L2, T/L3	M10	18 to 23 (159 to 204)	1 to 600	400
		U/T1, V/T2, W/T3	M10	18 to 23 (159 to 204)	1/0 to 600	400
		-, +1	M10	18 to 23 (159 to 204)	3/0 to 600	—
		+3	M10	18 to 23 (159 to 204)	1 to 325	—
			M10	18 to 23 (159 to 204)	2 to 350	2
F7	4132	R/L1, S/L2, T/L3, -, +1, R1/L11, S1/L21, T1/L31	M10	17.6 to 22.5 (154.8 to 197.5)	N/A	3/0×2P
		U/T1, V/T2, W/T3,	M10	17.6 to 22.5 (154.8 to 197.5)	N/A	2/0×2P
		+3	M8	8.8 to 10.8 (77.4 to 95.0)	N/A	—
			M12	31.4 to 39.2 (276.2 to 344.8)	N/A	4/0
		$\overline{r/\ell_1}, \overline{\Delta 200/}$ $\overline{\ell_2 200}, \overline{\Delta 400/}$ $\overline{\ell_2 400}$	M4	1.3 to 1.4 (11.4 to 12.3)	N/A	16



## 11 Appendix 3 Terminal Size and Wire Gauge

Series	Model	Terminal Signal	Terminal Screw	Tightening Torque N · m (lb.in.)	Wire Range AWG, kcmil	Recommended Gauge AWG, kcmil
A1000	4A0296	R/L1, S/L2, T/L3	M12	32 to 40 (283 to 354)	2/0 to 600	500
		U/T1, V/T2, W/T3	M12	32 to 40 (283 to 354)	2/0 to 600	500
		-, +1	M12	32 to 40 (283 to 354)	3/0 to 600	—
		+3	M10	18 to 23 (159 to 204)	1 to 325	—
			M12	32 to 40 (283 to 354)	2 to 350	2
F7	4160	R/L1, S/L2, T/L3, -, +1, R1/L11, S1/L21, T1/L31	M12	31.4 to 39.2 (276.2 to 344.8)	N/A	4/0×2P
		U/T1, V/T2, W/T3,	M12	31.4 to 39.2 (276.2 to 344.8)	N/A	3/0×2P
		+3	M8	8.8 to 10.8 (77.4 to 95.0)	N/A	—
			M12	31.4 to 39.2 (276.2 to 344.8)	N/A	1/0×2P
		r/l1, $\Delta$ 200/ l2200, $\Delta$ 400/ l2400	M4	1.3 to 1.4 (11.4 to 12.3)	N/A	16
A1000	4A0362	R/L1, S/L2, T/L3	M12	32 to 40 (283 to 354)	3/0 to 600	4/0×2P
		U/T1, V/T2, W/T3	M12	32 to 40 (283 to 354)	3/0 to 600	4/0×2P
		-, +1	M12	32 to 40 (283 to 354)	4/0 to 600	—
		+3	M10	18 to 23 (159 to 204)	3/0 to 600	—
			M12	32 to 40 (283 to 354)	1 to 350	1
F7	4185	R/L1, S/L2, T/L3	M16	78.4 to 98 (693.9 to 867.4)	N/A	300×2P
		U/T1, V/T2, W/T3, R1/L11, S1/L21, T1/L31	M16	78.4 to 98 (693.9 to 867.4)	N/A	300×2P
		-, +1	M16	78.4 to 98 (693.9 to 867.4)	N/A	600×2P
		+3	M16	78.4 to 98 (693.9 to 867.4)	N/A	—
			M16	78.4 to 98 (693.9 to 867.4)	N/A	3/0×2P
		r/l1, $\Delta$ 200/ l2200, $\Delta$ 400/ l2400	M4	1.3 to 1.4 (11.4 to 12.3)	N/A	16
A1000	4A0414	R/L1, S/L2, T/L3	M12	32 to 40 (283 to 354)	4/0 to 300	300×2P
		U/T1, V/T2, W/T3	M12	32 to 40 (283 to 354)	4/0 to 300	300×2P
		-, +1	M12	32 to 40 (283 to 354)	3/0 to 300	—
		+3	M12	32 to 40 (283 to 354)	3/0 to 300	—
			M12	32 to 40 (283 to 354)	1 to 3/0	1

## 11 Appendix 3 Terminal Size and Wire Gauge





Series	Model	Terminal Signal	Terminal Screw	Tightening Torque N · m (lb.in.)	Wire Range AWG, kcmil	Recommended Gauge AWG, kcmil
F7	4220	R/L1, S/L2, T/L3, R1/L11, S1/L21, T1/L31	M16	78.4 to 98 (693.9 to 867.4)	N/A	500×2P
		U/T1, V/T2, W/T3,	M16	78.4 to 98 (693.9 to 867.4)	N/A	400×2P
		-, +1	M16	78.4 to 98 (693.9 to 867.4)	N/A	250×4P
		+3	M16	78.4 to 98 (693.9 to 867.4)	N/A	—
			M16	78.4 to 98 (693.9 to 867.4)	N/A	250×2P
		$\frac{r}{\ell} \ell 1, \overline{\Delta} 200/$ $\ell 200, \overline{\Delta} 400/$ $\ell 2400$	M4	1.3 to 1.4 (11.4 to 12.3)	N/A	16
A1000	4A0515	R/L1, S/L2, T/L3	M12	32 to 40 (283 to 354)	3/0 to 300	3/0×4P
		U/T1, V/T2, W/T3	M12	32 to 40 (283 to 354)	3/0 to 300	4/0×4P
		-, +1	M12	32 to 40 (283 to 354)	1/0 to 300	—
		+3	M12	32 to 40 (283 to 354)	1/0 to 300	—
			M12	32 to 40 (283 to 354)	1/0 to 300	1/0
F7	4300	R/L1, S/L2, T/L3	M16	78.4 to 98 (693.9 to 867.4)	N/A	250×4P
		R1/L11, S1/L21, T1/L31	M16	78.4 to 98 (693.9 to 867.4)	N/A	250×4P
		U/T1, V/T2, W/T3	M16	78.4 to 98 (693.9 to 867.4)	N/A	4/0×4P
		-, +1	M16	78.4 to 98 (693.9 to 867.4)	N/A	400×4P
		+3	M16	78.4 to 98 (693.9 to 867.4)	N/A	—
			M16	78.4 to 98 (693.9 to 867.4)	N/A	400×2P
		$\frac{r}{\ell} \ell 1, \overline{\Delta} 200/$ $\ell 200, \overline{\Delta} 400/$ $\ell 2400$	M4	1.3 to 1.4 (11.4 to 12.3)	N/A	16
A1000	4A0675	R/L1, S/L2, T/L3, U/T1, V/T2, W/T3	M12	32 to 40 (283 to 354)	4/0 to 300	300×4P
		-, +1	M12	32 to 40 (283 to 354)	1/0 to 300	—
		+3	M12	32 to 40 (283 to 354)	1/0 to 300	—
			M12	32 to 40 (283 to 354)	2/0 to 300	2/0

Table 21 Control Circuit Terminal Size and Wire Gauge

Power Supply	Series	Capacity	Terminal Signal	Terminal Screw	Tightening Torque lb-in (N · m)	Possible Gauges AWG (mm <sup>2</sup> )	Recommended Gauges AWG (mm <sup>2</sup> )
200 V Class 400 V Class	F7	All capacities	FM, AC, AM, A1, A2, A3, +V, -V, S1, S2, S3, S4, S5, S6,S7, S8, SN, SC, SP, RP, MA, MB, MC, M1,M2, M3, M4, M5, M6,	Phoenix type	4.2 to 5.3 (0.5 to 0.6)	Stranded wire: 26 to 16 (0.14 to 1.5)	18 (0.75)
			MP, RP, R+, R-, S+, S-, IG	Phoenix type	4.2 to 5.3 (0.5 to 0.6)	Stranded wire: 26 to 16 (0.14 to 1.5)	18 (0.75)
			E (G)	M3.5	7.0 to 8.8 (0.8 to 1.0)	20 to 14 (0.5 to 2.0)	12 (1.25)
200 V Class 400 V Class	A1000	All capacities	FM, AC, AM, P1, P2, PC, SC, SN, SP, A1, A2, A3, +V, -V, S1, S2, S3, S4, S5, S6,S7, S8, MA, MB, MC, M1-M6	M3	4.4 to 5.3 (0.5 to 0.6)	stranded wire: 24 to 16 (0.2 to 1.0) solid wire: 24 to 16 (0.2 to 1.5) Ferrule-Type: 24 to 20 (0.25 to 0.5)	Bare Wire: 18 (0.75) Ferrule-Type: 20 (0.5)
			MP, RP, R+, R-, S+, S-, IG DM+, DM-, H1, H2, HC	M3	4.4 to 5.3 (0.5 to 0.6)		Bare Wire: 18 (0.75) Ferrule-Type: 20 (0.5)
			E (G)	—	—	—	—

# YASKAWA AC Drive

## F7 to A1000

# Product Transition Guide

---

**YASKAWA AMERICA, INC.**

2121 Norman Drive South, Waukegan, IL 60085, U.S.A.  
Phone: (800) YASKAWA (927-5292) or 1-847-887-7000 Fax: 1-847-887-7310  
<http://www.yaskawa.com>



YASKAWA AMERICA, INC.

In the event that the end user of this product is to be the military and said product is to be employed in any weapons systems or the manufacture thereof, the export will fall under the relevant regulations as stipulated in the Foreign Exchange and Foreign Trade Regulations. Therefore, be sure to follow all procedures and submit all relevant documentation according to any and all rules, regulations and laws that may apply.

Specifications are subject to change without notice for ongoing product modifications and improvements.

© 2011 YASKAWA AMERICA, INC. All rights reserved.

DOCUMENT NO. PL.A1000.02

Published in U.S.A January 2011 11-01